

# MASTERFLEX®

## ENCYCLOPEDIA VOL. 6.0

The Definitive Guide for Masterflex Peristaltic Tubing Pump Systems

Tried, tested, and trusted around the world!



## NEW PRODUCT HIGHLIGHTS

### I/P® DIGITAL PROCESS DRIVES

- ▶ IP66 and NEMA 4X-rated; spray or hose down to clean
- ▶ Sealed housing available in seamless 316 stainless steel or powder-coat steel
- ▶ Intuitive graphical interface for easy setup and operation
- ▶ Dispense by volume, time, or copy; cumulative volume and batch function
- ▶ Flow rates from 0.0006 to 19 LPM with I/P pump tubing
- ▶ See pages 140–141



### I/P® PRECISION MODULAR DRIVES

- ▶ Modular format lets you place drive and controller where convenient
- ▶ Available with either a benchtop or washdown wall-mount controller
- ▶ Three-digit LED displays speed in rpm—ensures repeatable settings
- ▶ Remote control of speed, start/stop, and direction
- ▶ Flow rates from 0.036 to 19 LPM with I/P pump tubing
- ▶ See pages 132–133



### L/S® DIGITAL MODULAR DISPENSING DRIVES

- ▶ Intuitive graphical interface for easy setup and operation
- ▶ Dispense by volume, time, or copy; cumulative volume and batch functions
- ▶ Modular format lets you place drive and controller where convenient
- ▶ Available with either a benchtop or washdown wall-mount controller
- ▶ Flow rates from 0.006 to 3400 mL/min with L/S pump tubing
- ▶ See pages 90–91



### MASTERFLEX® TYGON® E-LFL PUMP TUBING



- ▶ The best pumping life of any clear Tygon tubing
- ▶ Non-DEHP tubing perfect for laboratory, food & beverage, and biopharm applications
- ▶ Sterilize via ethylene oxide gas or autoclave
- ▶ Compliant with USP Class VI, FDA, EP 3.2.9, ISO 10993, EU Food
- ▶ See pages 22, 34, 69, 71, 127–128, and 153

### L/S® VARIABLE-SPEED DIGITAL DRIVES

- ▶ Flow rates from 0.001 to 3400 mL/min with L/S pump tubing
- ▶ New antidrip function ensures dispensing accuracy
- ▶ Brushless motor offers  $\pm 0.1\%$  speed control accuracy with a 6000 to 1 turndown
- ▶ Features a maintenance-free, high-accuracy motor and a graphical interface for easy setup and operation
- ▶ See pages 88–89



### PURI-FLEX™ PUMP TUBING



- ▶ Ultrapure formulation for the most critical pharmaceutical and biopharm applications
- ▶ No DEHP, REACH-compliant, ultralow extractables and leachables, no animal-derived components
- ▶ Meets USP Class VI and FDA 21 CFR 177.2600 standards
- ▶ Heat weldable and sealable
- ▶ Autoclave at the new higher 135°C (275°F) standard
- ▶ See pages 21, 34, 68, 70, 126, 128, and 153





## TABLE OF CONTENTS

### MASTERFLEX® TUBING PUMPS INTRODUCTION

ColeParmer.com online services.....	2-3
Masterflex® tubing pumps—solutions from start to finish.....	4
Masterflex® OEM design and engineering services .....	5
Typical Masterflex® applications .....	6-13
How Masterflex® pump heads work .....	14
Comparing pumping technologies .....	14-17
Frequently asked questions about Masterflex® pumps .....	17
How to select your pump system .....	18
Why choose Masterflex® pump tubing? .....	19
Masterflex® pump tubing formulation descriptions.....	20-24
Tubing formulation highlights.....	25-29
Masterflex® tubing chemical compatibility charts .....	30-31
Masterflex® pump types: C/L®, L/S®, I/P®, B/T® .....	32-33

### MASTERFLEX® C/L® TUBING PUMPS

Pump systems.....	34-37
Microbore pump tubing .....	34, 36

### MASTERFLEX® L/S® TUBING PUMPS

#### L/S® PUMP HEADS

Selection guide.....	38-39
Standard .....	40-41
Easy-Load® 3.....	42-43
Easy-Load® II .....	44-45
Easy-Load® .....	46-47
High-Performance .....	48-49
PTFE-Tubing .....	50-51
Multichannel.....	52-55
Multichannel cartridge .....	56-59
PTFE-Diaphragm .....	60-61
Micropump® gear pump heads, adapters, and drives .....	62-65
Ismatec® minicartridge pump heads and tubing sets .....	66
Valveless piston pump heads and adapters.....	67

#### L/S® TUBING

Precision pump tubing .....	68-69
High-performance precision pump tubing .....	70-71
Sanitary pump tubing assemblies .....	72
Spooled and bulk-packed pump tubing .....	73

#### L/S® DRIVES/DISPENSERS

Selection guide.....	74-75
Fixed-speed.....	76-77

#### Variable-Speed

Compact, low-flow.....	78-81
Economy analog console .....	82-83
Precision console .....	84-85
Precision modular benchtop and wall-mount.....	86-87
Digital console brushless .....	88-89
Digital modular brushless benchtop and wall-mount.....	90-91
Digital process .....	92-93

#### Specialty

Computer-compatible digital brushless .....	94-95
ServoDyne™ and Stir-Pak® mixer systems .....	96-97
Digi-Staltic® modular dispensing system .....	98-100
Air-powered .....	101
Hazardous duty .....	102
NEMA Type 56C pump head adapters.....	103
Portable samplers.....	104-105
Composite digital sampler .....	106
DC-powered.....	107

#### L/S® COMPLETE PUMP SYSTEMS

Complete tubing pump systems .....	108-117
------------------------------------	---------

### MASTERFLEX® I/P® TUBING PUMPS

#### I/P® PUMP HEADS

Selection guide .....	118-119
Standard .....	120-121
Easy-Load® .....	122-123
High-Performance .....	124-125

### MASTERFLEX® I/P® TUBING PUMPS (continued)

#### I/P® TUBING

Precision pump tubing .....	126-127
High-performance precision pump tubing .....	128
Sanitary pump tubing assemblies .....	129
Spooled and bulk-packed pump tubing .....	130

#### I/P® DRIVES

Selection guide.....	131
----------------------	-----

#### Variable-Speed

Precision modular benchtop and wall-mount.....	132-133
Analog process .....	134-137
Digital modular benchtop and wall-mount.....	138-139
Digital process .....	140-141

#### Specialty

Air-powered .....	142
Fixed-speed process .....	143
Hazardous-duty .....	144
NEMA Type 56C pump head adapters.....	145

#### I/P® COMPLETE PUMP SYSTEMS

Complete tubing pump systems .....	146-151
------------------------------------	---------

### MASTERFLEX® B/T® TUBING PUMPS

Selection guide .....	152
PerfectPosition™ pump tubing .....	153
Variable-speed analog drives .....	154-155
Variable-speed air-powered drives .....	154-155
Variable-speed modular digital drives .....	156-157
Fixed-speed analog drives .....	158
Rapid-Load® pump heads.....	159

### ACCESSORIES

Liqui-Sense® fluid monitoring system .....	160-161
Fittings.....	162-166
Tubing accessories .....	166-167

### PARTS

Replacement parts for L/S® and I/P® pump heads .....	168-169
Replacement parts for Masterflex® drives.....	170-171

### TECHNICAL DATA

#### MASTERFLEX® PERFORMANCE DATA

C/L® microbore tubing life data .....	172
L/S® tubing life data .....	173-175
I/P® tubing life data.....	176-178
B/T® tubing life data .....	179-180
Flow rates for Masterflex® pump heads.....	181-183
Pressure and suction lift data for Masterflex® pump heads .....	184-185
Pump head torque requirements.....	186-187
Application tips	
Dispensing applications .....	188-189
Pumping abrasive and viscous fluids.....	190
Tubing selection guide for viscous fluids.....	191
Vacuum/suction lift data .....	192

#### GENERAL TECHNICAL DATA

Cord/plug guide .....	193
Regulatory agencies and approvals.....	193
Ingress protection (IP) ratings.....	194
NEMA/IEC ratings .....	194
Standard pipe threads.....	194
ATEX directive and classifications.....	195
NEC classifications.....	195
Glossary of terms .....	196
Conversion factor tables.....	197
Chemical resistance charts .....	198-206
Index.....	207-208

## MASTERFLEX PUMPS AND TUBING—TRIED, TESTED, AND

Only Masterflex offers unparalleled versatility and standard-setting reliability—performance produced by more than 55 years of manufacturing peristaltic pumps. Our experience makes us fluid handling experts with the technical resources to help you design the exact pump system you need. Simply go to [www.coleparmer.com/masterflex](http://www.coleparmer.com/masterflex) to take advantage of these free resources 24 hours a day:

### CHEMICAL COMPATIBILITY DATABASE COLEPARMER.COM/MFLEXCHEM

Check the chemical compatibility of materials with the fluids in your experiment or process. The database includes the chemical resistance information for Masterflex tubing formulations at a glance.

Cole-Parmer's Chemical Compatibility Database App

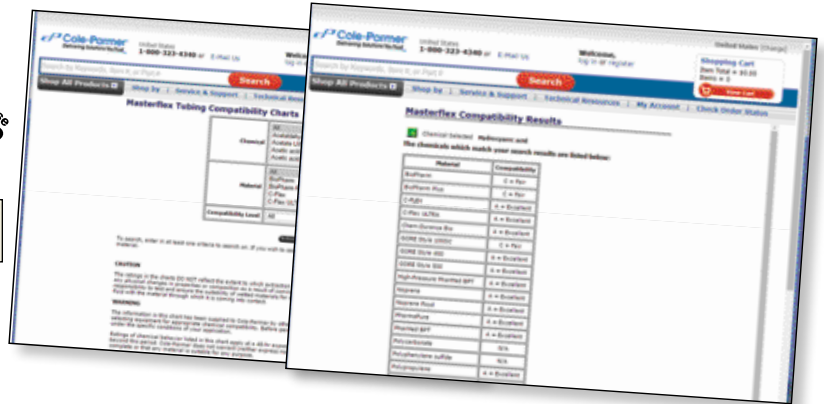

### APPLICATIONS SOLUTIONS DATABASE

#### COLEPARMER.COM/MASTERFLEX-APPLICATIONS

Search our Applications Solutions Database to see how other users have found solutions to similar applications with Masterflex pumps! Read success stories from a wide variety of industries and leverage the experience of a worldwide Masterflex user community. Plus, discover innovative uses for versatile Masterflex tubing pump systems.



### PUMP SYSTEM CONFIGURATOR

#### COLEPARMER.COM/MASTERFLEXCONFIGURATOR

Find the right peristaltic pump for your needs! The Masterflex Online Pump Configurator is an interactive tool. Simply input your pumping parameters and instantly view a list of appropriate Masterflex product recommendations.



### VIDEOS

#### COLEPARMER.COM/VIDEOS

Learn how to install and use your Masterflex pump system more effectively! Our collection of video tutorials walks you through the steps of installing, calibrating, and using your Masterflex pump for optimal performance.



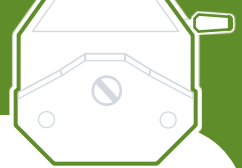

# AND TRUSTED AROUND THE WORLD!

## TECHNICAL LIBRARY

### COLEPARMER.COM/TECHINFO

Find helpful technical articles, application-based resources, selection guides, white papers, operating manuals, newsletters, and more! Browse this useful information to understand the power of Masterflex tubing pumps and their uses in nearly every industry:



- Laboratory research
- Environmental
- Industrial
- Chemical
- Food & Beverage
- Pharmaceutical
- And more!

## PRODUCT REVIEWS

Support delivered! Masterflex pumps have proven versatile and effective for customers in many industries. Don't just take our word for it—customer-written product reviews tell the story. Read what other users are saying about their experiences with Masterflex pumps and tubing.

“We used this product several times in our laboratory. It is very durable and sturdy. We will continue to use this product, and hopefully maintain a solid relationship with Cole-Parmer in years to come.”



“We use this product... and it works like a dream.”



“I purchased one of these about a year ago and was very happy with it so I purchased another one. We have had no problem with it.”

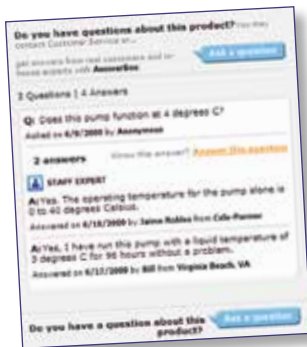

## ANSWERBOX ONLINE PRODUCT SUPPORT

Ask questions about a specific product and get answers from both in-house technical experts and actual product users. Like product reviews, past AnswerBox discussions are available for web site users to read—and may often solve the problem!

FULL SUPPORT WHENEVER YOU NEED IT—JUST A CLICK AWAY AT [COLEPARMER.COM/MASTERFLEX](http://COLEPARMER.COM/MASTERFLEX)



## MASTERFLEX® TUBING PUMPS—FROM CONCEPT TO APPLICATION

**Masterflex® tubing pump systems are made to exact specifications using a proven process developed over more than 55 years. This is key to our promise to deliver solutions you trust.**

### CUSTOMER INPUT

Before we create any Masterflex® tubing pump, we define the unique needs of our customers.



Customer Input

### CONCEPT

This is where we put our over 50 years of experience in developing more than 5,000 products to work. It's where we consider all the possibilities, including specific applications, product adaptability, and costs.



Engineering

### ENGINEERING

Once a product is conceptualized, proven procedures are maintained to control and verify its design to ensure that specified requirements are met.



Prototyping

### TESTING

The appearance of the following regulatory agency icons are your assurance that those products meet applicable standards for safety and reliability:



### PRODUCTION

Masterflex pumps are manufactured in a facility whose quality management system is registered to ISO 9001:2008.



Testing

### CUSTOMER/APPLICATION SERVICES

#### SERVICES

Our partnership with you doesn't end with the sale. We are available for follow-up, technical support, and service to ensure you are completely happy with your product. Our maintenance staff is available to quickly handle repairs and can help you identify replacement parts.

Finally, our expert Application Specialists can help you with product selection and maintenance, and offer you continuous support.



Customer/  
Application  
Services



## Markets Served

- ▶ Biotechnology
- ▶ Pharmaceutical
- ▶ Chemical
- ▶ Food & Beverage
- ▶ Cosmetics
- ▶ Industrial
- ▶ Research & Development
- ▶ Printing
- ▶ Water/Wastewater
- ▶ Manufacturing
- ▶ Semiconductors
- ▶ Textiles
- ▶ Education
- ▶ Environmental and more...

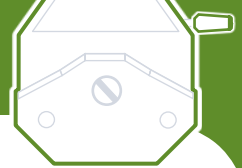

## OEM DESIGN CAPABILITIES

Our Original Equipment Manufacturer (OEM) team has more than 100 years of combined experience in custom designing fluid handling solutions. We provide thousands of quality products for scientific, technical, and industrial applications worldwide. When you require a product that is different from the products we advertise, or you need a feature from one of our products to meet your specific system requirement, we offer our OEM services.

### CAPABILITIES

We are known as an industry leader in the design, engineering, and manufacturing of peristaltic tubing and hose pumps, diaphragm metering pumps, vacuum/pressure pumps, flowmeters, and mixers.

### MARKETS AND APPLICATIONS

We specialize in the following markets: medical, semiconductor, wastewater treatment, food and beverage, biotechnology, filtration, pharmaceutical, environmental, printing, and metal finishing. Our products are used as irrigation and cooling pumps for medical devices, auto-analyzer pumps, pumping inks onto electric cable insulation, high-purity filtration systems, and many more specialized needs.

### WORK DIRECTLY WITH OUR EXPERT

#### OEM ENGINEERS

Our first objective is defining your needs. We will discuss the project in detail—engineering staff to engineering staff. Once we jointly define your requirements, we will work with you through the entire design and manufacturing process.

### AFTER-SALE TECHNICAL SUPPORT IS A KEY SERVICE WE PROVIDE

Our partnership doesn't end with product delivery. We are always available for follow-up service and technical support. We want to ensure that you remain completely satisfied with your final product.

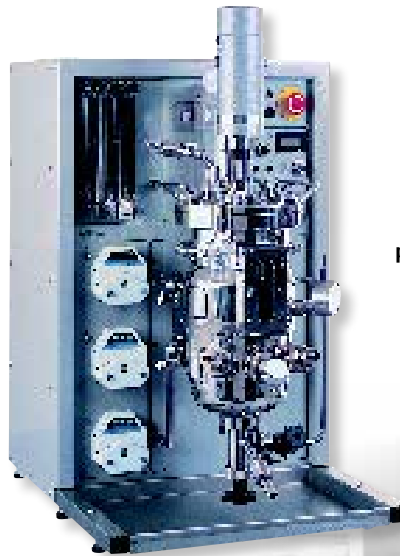

Our custom design group provides win-win solutions for your product design.

### TECHNICAL INFO

High-quality products conform to the following standards:

- ▶ ISO 9001:2008 Quality Management
- ▶ ETL Safety
- ▶ UL Safety
- ▶ cUL Safety, Canada
- ▶ CE – Electrical emissions
- ▶ EN61010 Safety, EU



INNOVATIVE PUMP SOLUTIONS FOR YOUR APPLICATIONS

1-847-549-7600

### FLOW PERFORMANCE

From volumes less than a teardrop to flow rates more than a fire hose, we can provide a custom solution for your specific fluid transfer needs.

**Flow rates:** less than 10 µL/min to more than 400 LPM

**Pressure performance:** up to 10.2 bar

- C/L® SERIES
- L/S® SERIES
- I/P® SERIES
- B/T® SERIES

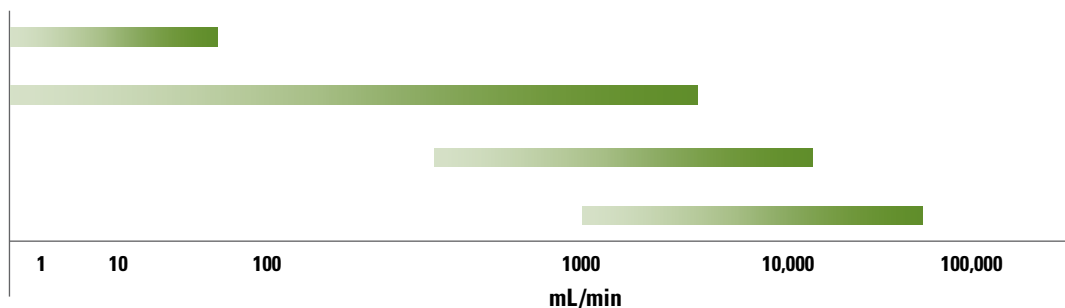

## MASTERFLEX® APPLICATIONS

Masterflex® tubing pump systems are perfect in the laboratory, manufacturing plant or field—for the end-user or OEM use. The convenient modular design of the systems (**Pump Head + Tubing + Drive**) allows you to use one pump drive for many applications, making Masterflex extremely versatile and cost-effective. The easy-loading pump head designs, coupled with a variety of specialty and general-use tubing formulations, make Masterflex the best choice for all your fluid handling needs.

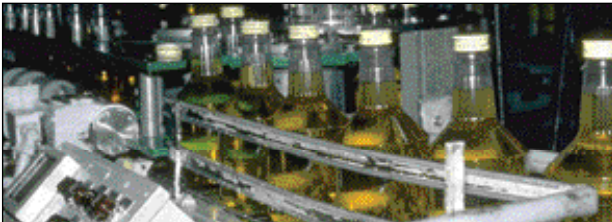
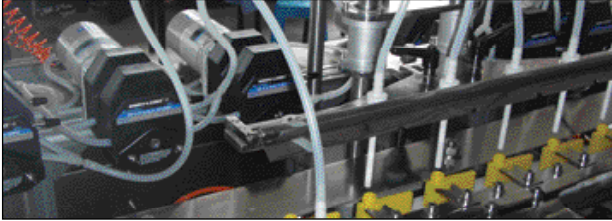

This Applications Section describes a small sample of Masterflex applications. The products being applied in these applications can help you determine the ideal Masterflex system for your needs. As always, you can call our Application Specialists to determine the best pump for your application.

### PHARMACEUTICAL & BIOTECH

Masterflex pumps are designed to be non-contaminating and noninvasive, making them the pumps of choice in the pharmaceutical industry. Easy-Load® pump heads and a wide range of drives fit many applications, from pumping nutrients or pH adjusters for fermentation, to dispensing cosmetics into small containers. Tubing is available that is compliant with USP Class VI, FDA, EP, and can be easily sterilized.

### RESEARCH & DEVELOPMENT

Masterflex tubing pump systems are ideal for research and development. The pumps are very easy to load and extremely versatile for use in the laboratory or process scale-up areas. Repeatability is excellent for low-volume dispensing and metering applications, and, under most conditions, the valveless design eliminates clogging and siphoning of fluid. These modular systems allow you to use one pump drive for many applications.

### INDUSTRIAL & MANUFACTURING

For everyday transferring and metering applications in the laboratory or plant, Masterflex pumps are the answer. They offer predictable service in continuous-duty areas, while solving many tough pumping applications. Use these pumps to handle wastewater, suspended solids, harsh chemicals and more; up to 42 LPM (11.1 GPM). The pumps are easy to use and maintain, and the drives are designed to handle the rugged environment of any plant.

### FOOD & BEVERAGE

Masterflex can handle a wide range of fluids, from hot water and vitamin solutions to thick molasses. The pump heads are designed for easy tubing exchange, and a wide selection of the drives have "wash-down" capabilities. Most importantly for food applications, Masterflex tubing is available that meets USP Class VI, FDA, NSF, EP, and 3A requirements.

### ENVIRONMENTAL & SPECIAL

Portability and convenience are built into every Masterflex environmental sampling pump. Choices of DC or AC systems facilitate simple, accurate sample collection. The suction lift and noninvasive/noncontaminating designs of our pump heads and tubing enable sample collection in accordance with EPA and other standard protocols.

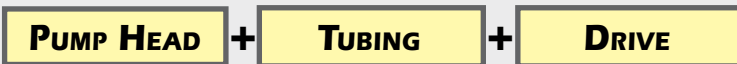

**MASTERFLEX®**  
**PUMP SYSTEM**





## PHARMACEUTICAL & BIOTECH

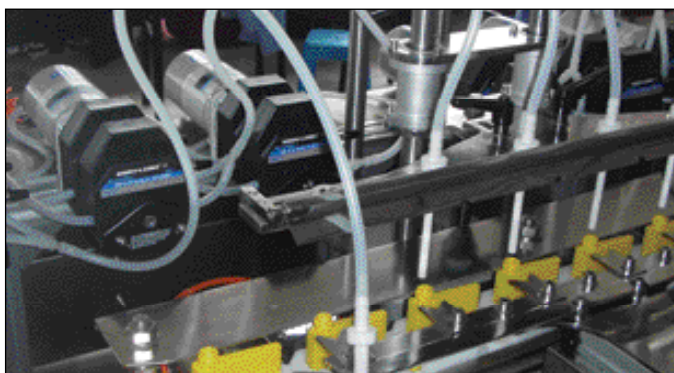

### APPLICATION EXAMPLES

- ▶ Harvesting cell media
- ▶ Manufacturing IV bag dispensing
- ▶ Spiral ultrafiltration
- ▶ Fermentation control
- ▶ Dissolution testers
- ▶ Cosmetic dispensing

FEATURES	BENEFITS
Wide range of tubing materials	Compatible with many laboratory chemicals.
Noncontaminating	Fluid media only contacts inside of tubing.
Easy cleanup	Just change the tubing to clean the pump
Multichannel capability	Use up to 32 channels simultaneously on one drive.
Sanitary connections on tubing	Quick tubing connections within sanitary systems.
Handles viscous materials	Dispense agars and suspensions.
Runs dry	Use as a low-flow aspirator or air/vacuum pump.
Modular design	Mix and match pump heads, tubing, and drives.
OEM packages	Design into your lab dispensers or analytical equipment.



### BIOPROCESS PUMP

- ▶ Accurately pump nutrient media from a bulk source into bio-bag sterile containers
- ▶ Silicone tubing for easy flow monitoring and biocompatibility; can be sterilized by gamma irradiation
- ▶ Flow rates: 0.28 to 1700 mL/min with L/S® 24 tubing
- ▶ Monitor flow rate, volume, batch count, cumulative volume, copy number, and rpm
- ▶ Easy calibration—store one value per tubing size
- ▶ Easy-Load® II pump head for fast tubing changes
- ▶ Drive is IP66 and NEMA 4X rated—easily cleaned or washed down after use

### Pump products shown

[HL-77200-62](#) L/S® Easy-Load® II Pump Head (pages 44–45)

[HL-96410-24](#) L/S 24 Platinum-Cured Silicone Tubing (pages 70–71)

[HL-07575-10](#) L/S Digital Process Drive (pages 92–93)



### FERMENTATION PUMP

- ▶ Pump media into or out of fermenters
- ▶ Meter additives, antifoam agents, and acid/base for pH control
- ▶ Noncontaminating; easy sterilization and cleanup
- ▶ Remote control of speed, direction, and start/stop
- ▶ Quick, easy tubing changes between samples
- ▶ Platinum-cured silicone tubing ensures excellent biocompatibility

### Pump products shown

[HL-77200-52](#) L/S Easy-Load II Pump Head (pages 44–45)

[HL-96410-16](#) L/S 16 Platinum-Cured Silicone tubing (pages 68–69)

[HL-07522-20](#) L/S Digital Standard Drive (pages 88–89)



### PROCESS FILTRATION PUMP

- ▶ Pump media and other fluids through sanitary process filters
- ▶ Noncontaminating; facilitates application of single-use tubing and assemblies
- ▶ Remote control of speed, direction, and start/stop
- ▶ Quick, easy tubing changes between process applications
- ▶ I/P 88 pump tubing offers flow up to 17 LPM and pressure up to 2.5 bar (35 psi)
- ▶ Sanitary tube set with premolded ends simplifies connections
- ▶ Drive is IP66 and NEMA 4X rated—easily cleaned or washed down after use

### Pump products shown

[HL-77600-62](#) I/P® High-Performance Pump Head (pages 124–125)

[HL-96112-88](#) I/P 88 PharMed® BPT Sanitary Tubing Assembly (page 129)

[HL-77420-10](#) I/P Digital Process Drive (pages 140–141)



### BULK MEDIA TRANSFER PUMP

- ▶ Modular format for convenient component placement; controller can be wall mounted
- ▶ IP56 rated controller and drive are protected from water spray in washdown environments
- ▶ Program dispense volume for repetitive filling protocols
- ▶ Flow rates up to 17.7 LPM with B/T 87 PerfectPosition™ PumpTubing
- ▶ Rapid-Load® pump head makes tubing changes quick and easy
- ▶ PharmaPure® tubing offers excellent pump life and meets EP, FDA, and USP classifications

### Pump products shown

[HL-06435-87](#) B/T® 87 PharmaPure® Pump Tubing (page 153)

[HL-77111-40](#) B/T Digital Modular Pump (pages 156–157)

## RESEARCH & DEVELOPMENT



### APPLICATION EXAMPLES

- ▶ Acid/base dispensing
- ▶ Aspiration of tissue culture media
- ▶ Circulation of cell suspension in fermentation
- ▶ Chromatography
- ▶ Coolant circulation in low temp baths
- ▶ Desiccator air circulation
- ▶ Distilled water transfer
- ▶ Dispensing agar into petri dishes
- ▶ Electrophoresis
- ▶ Elutriation
- ▶ Filtration pumps
- ▶ Flow injection analysis
- ▶ Gas sampling system
- ▶ Gel column pump
- ▶ Injection metering pump
- ▶ Liquid-phase chemiluminescence
- ▶ Magnetic particle separation
- ▶ Nutrient supply for cultures
- ▶ pH acid/base metering
- ▶ Spectrophotometer pump
- ▶ Sterilized media dispensing
- ▶ Transfer pump-circulating baths
- ▶ Toxicology assays (salt solutions)

FEATURES	BENEFITS
Modular design	Mix/match pump heads, tubing, and drives for many applications.
Noncontaminating	Fluid media only contacts inside of tubing.
Adjustable occlusion	Over-occlude for priming and pressure; reduce for longer tubing life.
Reversible	Operate in both directions without disconnecting tubing.
Wide range of tubing materials	Compatible with numerous laboratory chemicals.
Multichannel capability	Use up to 32 channels simultaneously on one drive.
Easy cleanup	Simply change the tubing to clean the pump.
Runs dry	Use as a low-flow aspirator or air/vacuum pump.
Easily sterilized	Sterilize tubing via ethylene oxide, gamma radiation, or autoclave.
High-accuracy dispenser	Calibrate digital drives for accuracies up to ±0.5%.
Low cell disruption	Circulate cell tissue with minimal damage (low shear).
Remote control	Interface with PC or other analytical instruments.
Self-priming	Generates vacuum up to 660 mm Hg (26" Hg).
Handles viscous materials	Dispense agars and suspensions.
OEM packages	Design into your lab dispensers or analytical equipment.



### ANALYZER FEED PUMP

- ▶ Perfect for low-flow analytical applications
- ▶ Connects easily to flow cells in spectrophotometers, refractometers, and other instruments
- ▶ Highly accurate—multiple rollers, continuous circulation, and reduced pulsation
- ▶ Compact size permits flexible placement on benchtop
- ▶ Silicone tubing offers clarity for visually monitoring fluid flow and excellent biocompatibility.

### Pump products shown

- ▶ [HL-95590-42](#) 2.06 mm ID Platinum-cured silicone Microbore Pump tubing (page 34)
- ▶ [HL-77122-14](#) C/L® Single-Channel Pump (pages 34–35)



### ELECTROPHORESIS CIRCULATION/COOLING PUMP

- ▶ Modular format permits convenient placement of components; drive can be placed in a hood or safety cabinet with controller outside
- ▶ Simple drive controls with separate speed control and on/off/reverse switch; turn pump on or off while maintaining speed settings
- ▶ Reversible motor for pumping in either direction
- ▶ Dual-channel head lets you pump two channels simultaneously
- ▶ Silicone tubing lets you make low-pressure connections in seconds
- ▶ Drive and L/S 16 tubing deliver a flow range of 4.8 to 480 mL/min

### Pump products shown

- ▶ [HL-77202-50](#) L/S® Easy-Load® II Dual-Channel Pump Head (pages 44–45)
- ▶ [HL-96400-16](#) L/S 16 Peroxide-Cured Silicone Pump Tubing (pages 68–69)
- ▶ [HL-07557-00](#) L/S Precision Modular Drive (pages 86–87)

### GRADIENT PUMP

- ▶ Remote programming and control via PC workstation
- ▶ Control functions include dispensing onto or off of a balance for gravimetric measurements
- ▶ Highly accurate; easy to program and calibrate
- ▶ Independently program up to 25 pump/mixers to develop gradients
- ▶ Program each pump or mixer for up to 50 steps
- ▶ Tygon® E-LFL tubing is clear for visually monitoring fluid flow



### Pump products shown

- ▶ [HL-07015-21](#) L/S Standard Pump Head (pages 40–41)
- ▶ [HL-06440-15](#) L/S 15 Tygon® E-LFL Pump Tubing (pages 70–71)
- ▶ [HL-07551-00](#) L/S Computer-Compatible Digital Drive (pages 94–95)
- ▶ See pages 96–97 for ServoDyne™ and Stir-Pak® mixer systems



## CHROMATOGRAPHY PUMP

- ▶ Low-pressure, low-volume flow for gravity-feed columns
- ▶ Dual-channel pump feeds two columns simultaneously
- ▶ Clarity of Tygon® tubing permits visual monitoring of flow
- ▶ Start/stop pump remotely
- ▶ Variable-speed pump accepts multiple tubing sizes for wide flow range
- ▶ Multi-roller pump is nonsiphoning; eliminating risk of backflow

### Pump products shown

[HL-06460-34](#) 1.42 mm ID Tygon® E-Lab Microbore Pump tubing (page 36)

[HL-77120-42](#) C/L Dual-Channel Pump (pages 36–37)



## ULTRAFILTRATION PUMP

- ▶ Transfers fluid through a filtration system at flow rates up to 13 LPM
- ▶ Maintains purity of raw materials/chemical solutions and sanitary integrity applications
- ▶ Allows for end product separations/harvesting
- ▶ Used in the QC/QA analysis labs for buffer and nutrient media filtration
- ▶ Ultra-low spallation PharmaPure® tubing ensures minimum particle entrapment; excellent biocompatibility and long life

### Pump products shown

[HL-77601-60](#) I/P® Easy-Load Pump Head (pages 122–123)

[HL-06435-73](#) I/P 73 PharmaPure® Pump Tubing (pages 126–127)

[HL-77410-10](#) I/P Brushless Process Drive (pages 134–137)

## AGAR DISPENSING PUMP

- ▶ Dispenses samples of agar from 0.05 to 8000 mL
- ▶ Highly accurate:  $\pm 0.5\%$
- ▶ No valves to clog
- ▶ Modular format lets you place drive module in a hood or safety cabinet with controller outside
- ▶ Easy-Load® II pump heads ensure low pulsation and accurate performance
- ▶ Silicone tubing is recommended for purity and is easily sterilized

### Pump products shown

[HL-77200-62](#) L/S Easy-Load II Pump Head (two included with Digi-Staltic system)

[HL-96410-35](#) L/S 35 Platinum-Cured Silicone Pump Tubing (page 70–71)

[HL-77310-00](#) L/S Digi-Staltic® Dispensing Pump System (pages 98–99)



## LAB/FILLING STATION PUMP

- ▶ Simple controls for routine transfer applications
- ▶ Reversible motor lets you prime or purge tubing
- ▶ Transfer chemicals at flow rates up to 2300 mL/min (36 GPH)
- ▶ Easy-Load® II pump head for quick changes between processes
- ▶ Substitute tubing based on compatibility with various chemicals (see pages 30–31)

### Pump products shown

[HL-77200-60](#) L/S Easy-Load II Pump Head (pages 44–45)

[HL-06509-18](#) L/S 18 Tygon® E-Lab Pump Tubing (pages 68–69)

[HL-07528-10](#) L/S Precision Variable-Speed Drive (pages 84–85)

[HL-07528-80](#) Handheld Remote Controller (page 85)

## INDUSTRIAL & MANUFACTURING



### APPLICATION EXAMPLES

- ▶ Adhesives for cement
- ▶ Carpet sanitizers/cleaners
- ▶ Caustic detergents
- ▶ Chemicals for car washers
- ▶ Dyes in fabric manufacturing
- ▶ Etching chemicals for plate processors
- ▶ Chlorine analyzers
- ▶ Dispensing glue emulsions
- ▶ Laundry chemicals
- ▶ pH control of effluent
- ▶ Smoke-generating machines
- ▶ Plating chemicals
- ▶ Pulp quality monitoring
- ▶ Microfilm developing machine
- ▶ Oil skimmer
- ▶ Silicone wafer rinse
- ▶ Crankcase oil analyzer
- ▶ Inks for lithographs
- ▶ Lubricator for ball bearings
- ▶ Coating for coils
- ▶ Tank transfer pumps
- ▶ Polishing slurry pump
- ▶ Web printing inks

FEATURES	BENEFITS
Wide range of tubing materials	Compatible with many industrial chemicals.
Noncontaminating	Fluid media only contacts inside of tubing.
Self-priming	Suction lifts up to 8.8 m (29 ft).
Runs dry	Handles liquids and gas easily without damaging the pump.
Easy cleanup	Simply change the tubing to clean the pump.
Reversible	Operate in both directions without disconnecting tubing.
Handles viscous materials	Transfer and dispense oils or fluids in suspension.
Modular design	Mix and match pump heads, tubing, and drives for many applications.
OEM packages	Design into your own industrial metering and transfer equipment.



### RAPID-DRY ADHESIVE TRANSFER

- ▶ Dosing various volumes of viscous (1200 cps), rapid-drying adhesive
- ▶ Eliminates problem of sticking valves, regular pump maintenance, and periodic pump failure
- ▶ High-performance precision tubing has a thicker wall and higher suction for handling viscous fluids
- ▶ Compatibility of silicone tubing allows it to be used more than once; oversizing the tubing allows pumping at speeds below 200 rpm
- ▶ Drive control features deliver desired accuracy and flexibility

#### Pump products shown

- [HL-77250-62](#) L/S® High-Performance Pump Head (pages 48–49)
- [HL-96410-24](#) L/S 24 Platinum-Cured Silicone tubing (pages 70–71)
- [HL-07522-20](#) L/S Standard Digital Drive (pages 88–89)



### BATCH CAUSTIC PUMP

- ▶ For batch/bulk transfer and corrosive fluid dispensing
- ▶ Flow rates up to 42 LPM with B/T® PerfectPosition™ pump tubing
- ▶ Ideal for viscous and shear-sensitive fluids
- ▶ Detachable controller for convenient component placement
- ▶ Rapid-Load® pump head makes changing tubing quick and easy
- ▶ IP56-rated, washdown controller and drive are protected from water spray
- ▶ C-FLEX tubing offers excellent compatibility with common acids and bases

#### Pump products shown

- [HL-06424-91](#) B/T® 91 C-FLEX® PerfectPosition™ Pump Tubing (page 153)
- [HL-77111-60](#) B/T Variable-Speed Pump (pages 154–155)

### CHEMICAL SAMPLING PUMP

- ▶ Program fluid volume for repeat sampling operations
- ▶ Controller is wall mountable for convenient location at sampling station
- ▶ Controller display shows operating parameters and run status
- ▶ Easy-Load head allows for quick tubing changes between batches or drums
- ▶ Pump head with PPS housing and stainless steel rollers resists corrosion and chemical attack
- ▶ Pump is self-priming and reversible; easily prime or purge tubing
- ▶ Substitute tubing based on compatibility with various chemicals (see pages 24–25)

#### Pump products shown

- [HL-77601-60](#) I/P® Easy-Load® Pump Head (pages 122–123)
- [HL-06404-73](#) I/P 73 Norprene® Pump Tubing (pages 126–127)
- [HL-07594-10](#) I/P Modular Digital Dispensing Drive (pages 138–139)





## WATER TREATMENT PUMP

- ▶ Brushless, maintenance-free motor for continuous duty
- ▶ Accurately meters chemical mixtures
- ▶ Digital display of flow rate, dispense volume, copy number, and motor rpm
- ▶ Quick, complete feedback loop of operations via remote signal
- ▶ Modular design lets you place controller where convenient
- ▶ IP66 rating permits hosedown when needed
- ▶ Easy-Load® II pump head for quick tubing changes and easy cleanup

### Pump products shown

- [HL-77200-62](#) L/S Easy-Load II Pump Head (pages 44–45)
- [HL-06404-24](#) L/S 24 Norprene® Pump Tubing (pages 70–71)
- [HL-77301-50](#) L/S Modular Digital Drive (pages 90–91)



## MULTICHANNEL FEED PUMP

- ▶ 100 rpm drive lets you stack up to four heads for increased capacity
- ▶ Change tubing quickly without dismounting heads
- ▶ Drive offers repeat dispensing functionality with batch count
- ▶ Heads accept multiple tubing sizes for application flexibility
- ▶ Chem-Durance® Bio pump tubing offers broad chemical compatibility and excellent pumping life
- ▶ Pump head with PPS housing and stainless steel rollers resists corrosion and chemical attack

### Pump products shown

- [HL-07518-62](#) L/S Easy-Load Pump Heads (pages 46–47)
- [HL-06442-15](#) L/S 15 Chem-Durance® Bio Pump Tubing (pages 70–71)
- [HL-07522-30](#) L/S Digital Standard Drive (pages 88–89)



## DYE/PIGMENT PUMP

- ▶ Brushless drive motor is maintenance free and continuous duty
- ▶ Epoxy powder coat paint resists corrosion and IP55 rating holds up to harsh environments
- ▶ Display of percent speed allows for repeatable rpm and flow settings
- ▶ Control drive speed remotely; pump running signal lets you monitor performance
- ▶ Powerful drive accepts two pump heads with any I/P tubing formulation
- ▶ Pump is self-priming and reversible; easily prime or purge tubing

### Pump products shown

- [HL-77601-10](#) I/P Easy-Load Pump Heads (pages 122–123)
- [HL-06404-73](#) I/P 73 Norprene® Pump Tubing (pages 126–127)
- [HL-77411-00](#) I/P Brushless Process Drive (pages 134–137)



## CARBOY TRANSFER PUMP

- ▶ Transfer chemicals at flow rates up to 8.0 LPM (2.1 GPM)
- ▶ Reversible motor lets you prime/purge tubing easily
- ▶ Pump is self-priming and nonsiphoning
- ▶ Easy-Load® pump head for quick changes between processes
- ▶ Tygon® E-Lab tubing is economical for frequent batch/fluid changes
- ▶ Substitute tubing based on compatibility with various chemicals (see pages 24–25)

### Pump products shown

- [HL-77601-10](#) I/P Easy-Load Pump Head (pages 122–123)
- [HL-06509-73](#) I/P 73 Tygon® E-Lab Pump Tubing (pages 126–127)
- [HL-07591-20](#) I/P Modular Digital Dispensing Drive (pages 138–139)

## FOOD & BEVERAGE

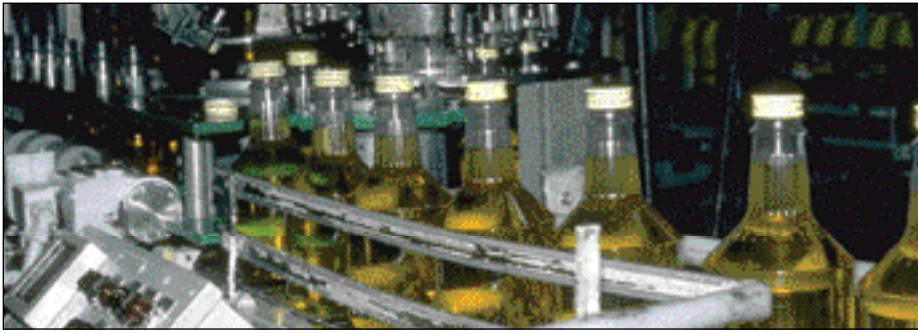

### APPLICATION EXAMPLES

- ▶ Pizza sauce dispensing
- ▶ Salad dressing pump
- ▶ Glass washing system
- ▶ Ice cream pump
- ▶ Automatic drain cleaners
- ▶ Popcorn butter dispensing
- ▶ Vitamin A & D injection

FEATURES	BENEFITS
High-purity	Fluid media only contacts tubing—USP, FDA, EP, 3A, NSF compliance.
Easy cleanup	Simply change the tubing to clean the pump.
Wide range of tubing materials	Compatible with many foods and chemicals.
Handles viscous materials	Transfer and dispense yogurts, ice cream, and food particles.
Easily sterilized	Sterilize by ethylene oxide, gamma radiation, or autoclave.
Adjustable occlusion	Over-occlude for priming; reduce for longer tubing life and particulates.
Reversible	Operate in both directions without disconnecting tubing.
Self-priming	Lift fluids up to 8.8 m (29 ft).
Modular design	Mix and match pump heads, tubing, and drives for many applications.
OEM packages	Design into your lab dispensers or analytical equipment.



### ADDITIVE/CONCENTRATE PUMP

- ▶ Compact—fits easily into OEM applications
- ▶ Pump operates “on demand” to dispense flavor concentrate
- ▶ Flow rate: 0.002 to 37 mL/min
- ▶ Easy to service and clean
- ▶ Tygon® E-LFL food-grade tubing offers USP and FDA compliance and long life

### Pump products shown

[HL-06449-48](#) 2.79 mm ID Tygon® E-LFL Microbore Pump Tubing (page 36)

[HL-77120-42](#) C/L® Dual-Channel Pump (pages 36–37)



### MULTICHANNEL DISPENSING PUMP

- ▶ Advanced digital drive offers programmable repeat dispensing functionality
- ▶ Cumulative volume totalizer and batch count
- ▶ Heads are stackable for expanded channel capacity
- ▶ Heads accept multiple tubing sizes for application flexibility
- ▶ Excellent between-channel accuracy (±1.5% or better)
- ▶ BioPharm Plus silicone offers superior dispensing precision and flow stability with no break-in

### Pump products shown

[HL-07535-04](#) L/S® Multichannel Pump Head (pages 54–55)

[HL-96116-16](#) L/S 16 BioPharm Plus Silicone Two-Stop Tubing Sets (page 55)

[HL-07522-20](#) L/S Digital Standard Drive (pages 88–89)



### DAIRY PROCESS PUMP

- ▶ Handles viscous materials
- ▶ Noncontaminating
- ▶ Self-priming (no valves)
- ▶ Easy cleanup, IP55 for washdown
- ▶ Delivers up to 8 LPM (2.1 GPM) with I/P® 73 Noreprene® food pump tubing
- ▶ Easy-Load® pump head facilitates quick tubing changes between samples
- ▶ Vary occlusion to handle purees, syrups, and other viscous fluids in the mixture
- ▶ Variable-speed drive features handles for convenient portability

### Pump products shown

[HL-77601-60](#) I/P® Easy-Load® Pump Head (pages 122–123)

[HL-06402-73](#) I/P 73 Noreprene® Food Pump Tubing (pages 126–127)

[HL-77411-00](#) I/P Brushless Process Drive (pages 134–137)



### SANITARY SAMPLING PUMP

- ▶ Drawing sanitary samples from process lines
- ▶ Stack pump heads to draw samples from multiple lines simultaneously
- ▶ Drive is easily programmed for repetitive sampling; program time delay (pause) between runs
- ▶ Control drive remotely via 0 to 20 mA, 4 to 20 mA, or 0 to 10 V signal; signal is scaleable and invertable
- ▶ Easy-Load II pump head permits fast tubing changes; pumping is contamination free
- ▶ Drive is IP66 and NEMA 4X rated—easily cleaned or washed down after use

### Pump products shown

[HL-77200-52](#) L/S Easy-Load II Pump Heads (pages 44–45)

[HL-96410-16](#) L/S 16 Platinum-Cured Silicone Pump Tubing (pages 68–69)

[HL-07575-10](#) L/S Digital Process Drive (pages 92–93)



## ENVIRONMENTAL & SPECIAL



### APPLICATION EXAMPLES

- ▶ Contaminated ground water
- ▶ Chemical drum sampling
- ▶ Enzyme isolation
- ▶ Flow injection analysis
- ▶ Greenhouse watering
- ▶ Fertilizer applications
- ▶ Pesticide delivery systems
- ▶ Sewage/sludge analysis
- ▶ Tree spraying
- ▶ Water salinity analyzers
- ▶ Wastewater sampling

FEATURES	BENEFITS
Noncontaminating	Samples collected only contact inside diameter (ID) of tubing.
Self-priming	Suction lifts up 8.8 m (29 ft)
Runs dry	Pump is not damaged when left unattended.
Wide range of tubing materials	Compatible with water or waste samples.
Easy cleanup	Simply change the tubing to clean the pump.
Reversible	Purge and collect sample with one pump.
Modular design	Mix and match pump heads, tubing, and DC, AC, or hand-operated drives.
OEM packages	Design into your water sampling or analytical equipment.



### HIGH-PURITY METERING PUMP

- ▶ Suitable for aggressive organic solvents
- ▶ Flow rates up to 65 mL/min with PTFE tubing
- ▶ Rigid tubing withstands pressure up to 6.9 bar (100 psi)
- ▶ PTFE-wetted parts allow contamination-free pumping
- ▶ Maintains high fluid purity
- ▶ Limited chemical exposure—fluid contacts only the tubing

#### Pump product shown

[HL-77390-00](#) L/S® PTFE Tubing Pump Head (pages 50–51)

[HL-77390-60](#) L/S PTFE Tubing Set (pages 50–51)

[HL-07528-20](#) L/S Precision Variable-Speed Drive (pages 84–85)

This pump is available as a complete system; see page 116 for details.



### COMPOSITE SAMPLER

- ▶ Program operation to meet EPA sampling requirements
- ▶ Dual-line, 24-character, backlit adjustable LCD with glow-in-the-dark keypad
- ▶ Locking latches prevent tampering; sampler floats up to 30 minutes if dropped in water
- ▶ Complete composite sampler system includes Easy-Load® pump head and L/S® tubing
- ▶ Passes through 18" diameter manhole
- ▶ Up to a 90-day standby for a remote signal
- ▶ Operates on an internal rechargeable battery, 12 VDC, or 115/230 VAC

#### Pump product shown

[HL-07518-12](#) L/S Easy-Load® pump head (included with sampler)

[HL-96400-24](#) L/S 24 Peroxide-Cured Silicone tubing (included with sampler)

[HL-07580-00](#) E/S® Composite Sampler (page 106)



### HAZARDOUS DUTY PUMP

- ▶ Ideal for transferring hydrocarbons, petroleum products, and distillates
- ▶ Suitable for gasoline, kerosene, heating oils, cutting fluids, and glycol-based coolants
- ▶ No electric power necessary; connect to existing air supply or compressor
- ▶ Ideal for hazardous-duty locations
- ▶ Intrinsically safe when properly grounded for static electricity
- ▶ Low-maintenance motor

#### Pump products shown

[HL-77601-60](#) I/P® Easy-Load Pump Head (pages 122–123)

[HL-06401-73](#) I/P 73 Tygon® Fuel & Lube Pump Tubing (pages 126–127)

[HL-07589-30](#) I/P Air-Powered Drive (page 142)

IN PUMP TECHNOLOGY COMPARISONS,

# MASTERFLEX® IS THE PREFERRED SOLUTION!

Precision, versatility, and ease of use make Masterflex peristaltic pump technology the preferred solution to increasing numbers of applications in the processing industry and in the lab.

The following comparisons prove that under real-world conditions, **Masterflex sets the standard for excellence.**

## HOW DO MASTERFLEX® PUMP HEADS WORK?

1

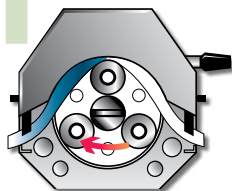

A pump head consists of only two parts: the rotor and the housing. The tubing is placed in the tubing bed—between the rotor and housing—where it is occluded (squeezed).

2

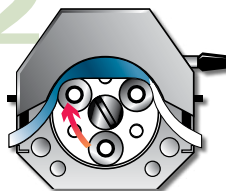

The rollers on the rotor move across the tubing, pushing the fluid. The tubing behind the rollers recovers its shape, creates a vacuum, and draws fluid in behind it.

3

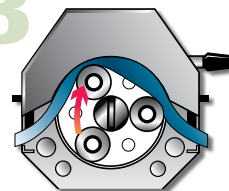

A "pillow" of fluid is formed between the rollers. This is specific to the ID of the tubing and the geometry of the rotor. Flow rate is determined by multiplying speed by the size of the pillow. This pillow stays fairly constant except with extremely viscous fluids.

## GEAR PUMPS VS MASTERFLEX®

### Application

A pharmaceutical customer needs to draw a constant volume of 800 mL/min of water with particulates. The customer needs variable speed and is drawing the fluid through a particle sensor.

### Gear Pump Disadvantages

- Does not handle particulates
- Difficult to clean
- Can't run dry
- Does not provide sterile conditions (fluid contacts internal pump parts)

### Masterflex® Advantages

- Handles particulates
- Easy to change out tubing and clean pump
- Runs dry
- Maintains sterility of fluid (fluid only contacts the tubing)

### Products Applied

- 77800-62 L/S® Easy-Load® 3 pump head
- 06424-35 C-FLEX® L/S® 35 High-performance precision tubing
- 07523-80 L/S® Digital standard console drive
- 07596-20 Pulse dampener



## DIAPHRAGM PUMPS VS MASTERFLEX®

### Application

A manufacturer needs to pump ethylene glycol from a 55-gallon drum into six smaller containers. Once these six containers are filled with the ethylene glycol, they are used to lubricate needles for their process.

### Solenoid Diaphragm Pump Disadvantages

- Does not handle high viscosities well—the flow would be reduced by 75% due to the 450-cp viscosity of ethylene glycol
- Requires routine maintenance and difficult to clean
- Numerous replacement parts: diaphragms and internal valves
- Check valves may stick and make pump inoperable

### Masterflex® Advantages

- Handles high viscosities well—improved customer's flow rate
- Fluid does not contact internal pump parts—only the tubing
- Easy tubing replacement; reduced maintenance time
- Excellent self-priming capabilities

### Products Applied

- 77601-10 I/P® Easy-Load® pump head (stack up to two heads)
- 06440-26 Tygon® E-LFL I/P® 26 Precision tubing
- 77410-10 I/P® Brushless process drive

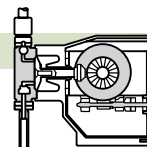





### SYRINGE PUMPS VS MASTERFLEX®

#### Application

A university research lab needs to pump a fixative (formaldehyde and glutaraldehyde in a phosphate buffer) to preserve brain tissue for research. They are pumping at low flow rates (20 to 40 mL/min) with four channels pumped at one time.

#### Syringe Pump Disadvantages

- ▶ Does not handle viscous fluids well
- ▶ Need special pumps and syringes
- ▶ Not self-priming
- ▶ Cannot pump any particulate matter
- ▶ Automated options are expensive at the lower flow rates
- ▶ More elaborate/difficult to set up

#### Masterflex® Advantages

- ▶ Handles high viscosities well
- ▶ Easy to change out tubing and clean/sterilize tubing
- ▶ Excellent self-priming capabilities
- ▶ Able to pump particulates
- ▶ Multichannel capabilities
- ▶ Cost efficient
- ▶ User-friendly LCD interface makes setup easy

#### Products Applied

- ▶ 07519-06 L/S® Multichannel cartridge pump head
- ▶ 07519-80 Small cartridges (eight)
- ▶ 06447-34 Tygon® E-LFL tube sets
- ▶ 07523-90 L/S® Brushless digital drive

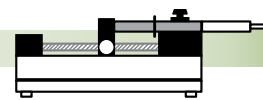

### PISTON PUMPS VS MASTERFLEX®

#### Application

A rubber manufacturer needs to dispense 1-mL doses of Methyl Ethyl Ketone (MEK) as a primer in the first step of the vulcanization process (treating rubber to give it certain properties). They need a pump that is easy to operate.

#### Piston Pump Disadvantages

- ▶ Chemical compatibility is challenging
- ▶ Difficult to regulate the 1-mL doses
- ▶ Difficult to clean (internal parts of pump head and valves)
- ▶ Can't run dry

#### Masterflex® Advantages

- ▶ Tubing formulations are more chemically compatible
- ▶ Simple to operate controls
- ▶ Easy to change out tubing and clean pump—reduces labor
- ▶ Runs dry to prime
- ▶ Maintenance is easier with no service kits or valves

#### Products Applied

- ▶ 77390-00 L/S® PTFE-tubing pump head
- ▶ 77390-60 L/S® PTFE tubing, 6-mm OD
- ▶ 07528-20 L/S® Variable-speed precision console drive

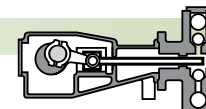

### DRUM PUMPS VS MASTERFLEX®

#### Application

A pharmaceutical customer needs to pump a disinfecting agent from a drum into an 8-gallon tank. They had been using a hand pump in the past but in order to reduce time and maintenance they would like an automated system.

#### Drum Pump Disadvantages

##### Hand Pump

- ▶ Manual, hard labor
- ▶ Not fast or efficient
- ▶ Risk of chemicals splashing on operator

##### Motorized Drum Pump

- ▶ Doesn't remove all of the fluid in the drum
- ▶ Most models don't run dry
- ▶ Does not have a lot of automated features
- ▶ Cleansing steps needed before use in next application

#### Masterflex® Advantages

- ▶ More efficient and fast at pumping fluids—reduces labor
- ▶ Excellent self-priming capabilities
- ▶ Empties entire tank/drum
- ▶ Runs dry
- ▶ Excellent chemical compatibility
- ▶ More automated features to program fluid flow—improved accuracy
- ▶ Change tubing and pump is ready for next application

#### Products Applied

- ▶ 77601-10 I/P® Easy-Load pump head
- ▶ 06475-82 Tygon® Chemical I/P® 82 Precision tubing
- ▶ 07594-10 I/P® Variable-speed modular digital dispensing drive

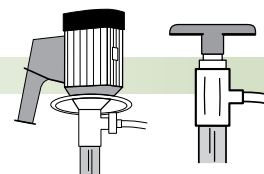

IN PUMP TECHNOLOGY COMPARISONS,

# MASTERFLEX® IS THE PREFERRED SOLUTION!

## CENTRIFUGAL PUMPS VS MASTERFLEX®

### Application

A food manufacturer needs to pump a glue (6000 to 9000 cp) into a labeler machine. The pump must be food-grade compatible. The glue is placed on a roller and then onto a palette, which places a thin layer of glue onto a bottle. The label is then placed onto the bottle by a separate machine.

### Centrifugal Pump Disadvantages

- ▶ Does not handle high viscosities
- ▶ Difficult to clean
- ▶ Limited automated capabilities

### Masterflex® Advantages

- ▶ Handles high viscosities well
- ▶ Easy to change out tubing and clean pump—less maintenance
- ▶ Washdown models allow for quick and easy cleaning
- ▶ Tubing is food-grade compatible
- ▶ Has more automated capabilities

### Products Applied

- ▶ 77111-60 B/T® Variable-speed washdown pump system
- ▶ 06399-91 Norprene® Food B/T® 91 Precision tubing



## AIR-OPERATED DOUBLE DIAPHRAGM PUMPS VS MASTERFLEX®

### Application

A cheese manufacturer needs to pump oil from a 55-gallon drum into small containers. Once placed in these containers, the oil is mixed with blocks of cheese and spices to create different flavors of cheeses. This company used an air-operated double diaphragm pump but was having difficulty with its operation.

### Air-Operated Double Diaphragm Pump Disadvantages

- ▶ Difficult to control the flow rate
- ▶ Large pulsation can cause air to be entrained in food product
- ▶ Difficult to clean and maintain sterility of internal parts of pump

### Masterflex® Advantages

- ▶ Easy to control flow with variable-speed drives—reduces manual operation
- ▶ Heads are stackable to minimize pulsation
- ▶ Easy to change out tubing
- ▶ Easy to maintain sterility of tubing and fluid path
- ▶ Offer food-grade tubing
- ▶ No valves to clean or maintain

### Products Applied

- ▶ 77601-10 I/P® Easy-Load® pump head
- ▶ 06418-73 Tygon® E-Food I/P® 73 Precision tubing
- ▶ 07589-30 I/P® Variable-speed air-powered drive



## FLEXIBLE IMPELLER PUMPS VS MASTERFLEX®

### Application

A research laboratory needs to pump dilute sulfuric acid and a copper sulfate solution continuously (24 hours a day) for five days in a row. They need to recirculate these two chemicals at 60°C for a cell lab. They need to be able to vary the flow rate with a maximum flow of 15 LPM at 15 psi.

### Flexible Impeller Pump Disadvantages

- ▶ Does not handle higher pressures at higher flow rates well
- ▶ Difficult to find chemically compatible internal pump parts
- ▶ Cannot run dry
- ▶ Variable flow control is difficult
- ▶ Difficult to clean

### Masterflex® Advantages

- ▶ Handles higher pressures at higher flow rates
- ▶ Chemically compatible with a variety of tubing formulations
- ▶ Runs dry
- ▶ Easy to control flow with a variable-speed pump drive
- ▶ Easy to change out tubing and clean pump

### Products Applied

- ▶ 77600-62 I/P® High-performance pump head
- ▶ 06440-88 Tygon® E-LFL I/P® 88 High-performance precision tubing
- ▶ 77420-10 I/P® Digital brushless process drive





## ROTARY LOBE PUMPS VS MASTERFLEX®

### Application

A university research facility needs to pump cell media into a system containing cells (the cells are living off of the media in the system). This system is used to simulate a human circulatory system for research purposes; therefore a constant flow rate needs to be maintained.

### Rotary Lobe Pump Disadvantages

- ▶ Difficult to pump precise flow rates
- ▶ Does not self-prime
- ▶ Cannot handle particulates
- ▶ Difficult to clean

### Masterflex® Advantages

- ▶ Easily maintains a precise, constant flow rate
- ▶ Excellent self-priming capabilities
- ▶ Multiple channel capabilities by stacking heads
- ▶ Able to handle shear-sensitive particulates/fluids
- ▶ Easy to change out tubing and clean/sterilize pump

### Products Applied

- ▶ 77200-60 L/S® Easy-Load® II pump head
- ▶ 06435-25 PharmaPure® L/S® 25 Precision tubing
- ▶ 07528-10 L/S® Precision standard console drive

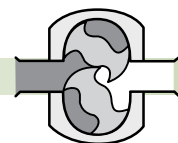

## FREQUENTLY ASKED QUESTIONS ABOUT MASTERFLEX® PUMPS

### FLOW RATES

#### What flow rates are attainable?

Depending on which series you select, our systems deliver flow rates from 0.0005 mL/min to 42 LPM.

#### What flow precision can I expect?

You can obtain a flow precision of better than ±1% with calibrated flow systems. For other systems, ±3% precision is possible for general transfer applications.

#### Are measured volumes repeatable?

Yes. Volumes are repeatable with accuracies of ±0.1% or better using calibrated systems.

#### What is the effect of viscosity on flow?

All flow rates are based on water. Increasing the fluid viscosity will decrease the flow rate. See pages 172–192 for information.

### PUMP HEADS

#### What is the maximum pressure?<sup>1</sup>

The maximum pressure using L/S® High-pressure tubing (see pages 48–49) is 10.2 bar (150 psi); nominal pressure is 1.7 bar (25 psi).

#### What is the maximum inlet pressure?<sup>1</sup>

Typically 2.7 bar (40 psi), depending on tubing ID, wall thickness, and formulation.

#### What is the maximum suction lift?

The maximum suction lift is 8.8 m H<sub>2</sub>O (29 ft H<sub>2</sub>O).

#### Are check valves required?

No. Our unique designs eliminate this need.

#### Can Masterflex pumps run dry?<sup>2</sup>

Yes. They can pump gases, liquids, or mixed phases.

#### Are Masterflex pumps self-priming?

Yes. They can develop a vacuum in excess of 660 mm Hg (26" Hg).

#### Are Masterflex pumps positive-displacement type pumps?

Yes. The flow rate with water is directly proportional to the rotor speed up to the maximum capabilities of the drive.

#### Are Masterflex pumps nonsiphoning?

Yes. One roller is always squeezing the tubing closed, so you don't get any backflow up to the rated pressure of the tubing/pump head.

#### Can slurries and abrasive solutions be pumped?

Yes. The limitations are viscosity and particle size relative to selected tubing ID.

#### Why are so many pump heads and tubing sizes offered?

To provide maximum flexibility in achieving desired flow at the optimal drive speed.

#### Is flow reversible?

Yes. All specifications apply in either clockwise or counterclockwise rotation.

### TUBING

#### Is the tubing important?

Yes. The tubing is the pump chamber. The elasticity of the tubing provides suction lift; its strength provides pressure handling ability; its flexibility determines pumping life; its bore determines the flow rate; and its wall thickness determines pumping efficiency.

#### What are the temperature ranges of tubing?

The temperature range for tubing is from –240 to 260°C (–400 to 500°F). For details on specific formulations, see pages 20–24.

#### What is the chemical resistance?

It depends on the tubing formulation you select. For detailed information, see pages 30–31.

#### How long will the tubing last?

Tubing life depends on pump speed and pressure, tubing material and chemical compatibility, and abrasiveness of the liquid (media) being pumped. See pages 20–24 and 172–192 for information.

#### How does pump speed affect tubing life?

To put it simply, the lower the speed, the longer the life of the tubing.

#### What tubing formulation gives longest life?

In order, Norprene®, PharMed® BPT, PharmaPure®, Chem-Durance® Bio, Puri-Flex™, Tygon® E-LFL, silicone, BioPharm Plus, and C-FLEX® last the longest. See pages 20–24 and 172–192 for information.

#### Is tubing available that is compatible for food and sanitary applications?

Yes. Some tubing formulations comply with NSF specifications, 3A, FDA, and USDA requirements for food handling. Many can be sterilized. See pages 20–24 for more information.

#### Is the tubing easy to replace?

Yes. The Easy-Load®, Easy-Load® II, Easy-Load® 3, High-performance, Multichannel cartridge, and Rapid-Load® pump heads make tubing changes quick and easy. Tubing in the Standard pump head is easy to change with the loading key provided.

### DRIVES

#### Why are drives sold separately from pump heads in the L/S® and I/P® series?

The modular concept lets you customize your system for flexibility and economy.

#### Can a single drive run more than one pump head?

In many cases, two to four pump heads can be stacked in any combination up to the max torque capability of the drive.

#### Are drive systems other than those shown in this catalog available?

Yes. Our Engineering Department can customize, design, or modify a drive or drive package to your specifications for quantity purchases and OEM applications. See page 5 for OEM pumps.

<sup>1</sup>PTFE-pump head can operate at pressures up to 6.8 bar (100 psi). (See pages 50–51.)

<sup>2</sup>Except the PTFE-pump head which can overheat when run dry.

## SELECTING YOUR MASTERFLEX® TUBING PUMP SYSTEM

# 1

### DEFINE YOUR APPLICATION REQUIREMENTS.

- A** What flow rate do I need?
- B** What chemical am I pumping?
- C** Do conditions such as fluid viscosity or back pressure play an important role in my application?

# 2

### SELECT A PUMP SERIES BASED ON YOUR FLOW RATE.

- A** C/L® 0.002 to 43 mL/min  
Pages 34–37
- B** L/S® 0.0006 to 3400 mL/min  
Pages 38–117
- C** I/P® 0.001 to 26 LPM  
Pages 118–151
- D** B/T® 0.3 to 42 LPM  
Pages 152–159

# 3

### SELECT A PUMP HEAD, TUBING, AND DRIVE.

- A** The L/S® and I/P® pump series are divided into three component categories—pump head, tubing, and drive.
- B** The icons at right appear throughout the Masterflex® section to show you which pump series and what components are listed on those pages.

HELP IN SELECTING YOUR MASTERFLEX PUMP SYSTEM IS AVAILABLE AT [MASTERFLEX.COM](http://MASTERFLEX.COM)

**MASTERFLEX®**  
Application Solutions

Scan this database of challenging fluid handling applications and the Masterflex® tubing pump systems that are meeting those challenges.

### •• PURCHASE A COMPLETE MASTERFLEX TUBING PUMP SYSTEM:

To find complete Masterflex tubing pump systems, look for the symbol below with all three components highlighted. This symbol indicates that you may purchase a complete Masterflex system with a single catalog number.

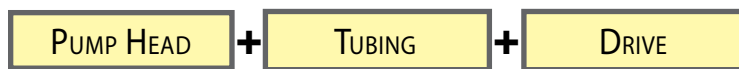

OR

### PURCHASE YOUR MASTERFLEX SYSTEM BY COMPONENTS

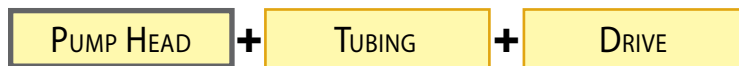

### WHAT TO CONSIDER:

- Flow rate**—Different pump heads have different flow rate capabilities.
- Tubing change frequency**—Some pump heads enable rapid tubing changes.
- Desired number of channels**—Pump heads are stackable in most cases.
- Chemical compatibility**—If chemicals spill, pump head materials become important.
- Accuracy**—Standard pump heads offer the most accurate, repeatable flow rates.

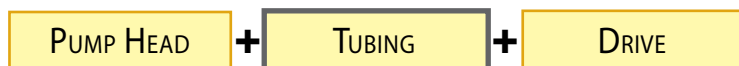

### WHAT TO CONSIDER:

- Flow rate**—Tubing size directly affects flow rate.
- Chemical compatibility**—See tables on pages 30–31.
- Tubing life**—See page 172–192.
- Fluid viscosity, presence of solids, back pressure, or suction lift**—High-performance tubing is best for these conditions. See pages 172–192.
- Fluid temperature**—Information concerning the temperature range for each tubing formulation can be found on pages 20–24.

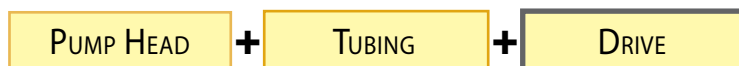

### WHAT TO CONSIDER:

- Flow rate**—The rpm of the drive directly correlates to flow rate.
- Fixed- or variable-speed**—Variable-speed drives enable flow rate adjustment.
- Accuracy of flow rate or dispense volume**—Many drives have digital speed control circuitry for highly accurate and repeatable flow rates.
- Remote control or computer interface**—Some drives can connect to your process controller or can be operated by a foot switch.
- Environmental protection against hazards**—Many drives are sealed against dust and water exposure.



## WHY CHOOSE MASTERFLEX® PUMP TUBING?

**Accept no substitutes—use only Masterflex tubing in your tubing pumps!**

- ▶ Precision extruded to meet tight tolerances
- ▶ Factory tested and optically inspected
- ▶ Engineered to comply with numerous standards and classifications

To ensure accurate flow rates and long tubing life, use only Masterflex tubing in your pump tubing applications. Our tubing is your best choice because, unlike general-purpose commodity tubing, it is specifically designed and manufactured for use in demanding peristaltic pump applications. Masterflex tubing will help you achieve top performance from your fluid transfer system. We offer 22 different tubing formulations in a variety of sizes for every application. Select Precision tubing or High-Performance Precision tubing, which improves pressure generation, suction lift, ability to pump viscous fluids, and tubing life.

### PUMP TUBING FOR A WIDE RANGE OF APPLICATIONS

Masterflex pump tubing is ideal for a wide range of applications in a number of markets, including:

- ▶ Biotech
- ▶ Chemical processing
- ▶ Education
- ▶ Environmental
- ▶ Food and beverage
- ▶ Industrial
- ▶ Laboratory
- ▶ Life Sciences: tissue and cell culture, fermentation
- ▶ Medical research
- ▶ Pharmaceutical
- ▶ Printing
- ▶ Semiconductors
- ▶ Water treatment

## SPECIAL TUBING FOR CHALLENGING APPLICATIONS

### **NEW** MASTERFLEX® Tygon® E-LFL Pump Tubing ..... page 22

Developed and thoroughly tested to be a long life pump tubing. This new formulation offers a non-DEHP and non-phthalate tubing. It has been aggressively tested and proven itself as an excellent improvement over the original LFL formulation. This new tubing has shown up to 20% improvement in our multi-pump testing environment. The classifications that come with the new E-LFL are: USP Class VI, EP 3.2.9, FDA compliant for food contact, and NSF 51. The tubing is REACH compliant for non-DEHP and non-phthalate, and animal derived component free.

### **NEW** MASTERFLEX® Tygon E-Food Pump Tubing ..... page 22

Developed based upon the objective of being Safe (non-DEHP, non-phthalate), Smart (worldwide compliance) and Sustainable (having a bio-based plasticizer). This new formulation has proven significant improvement on pump life. The classifications that come with new E-Food are FDA compliant for food contact, 3A, and NSF 51.

### MASTERFLEX® Exclusive Puri-Flex™ Pump Tubing ..... page 21

A long-life tubing engineered to meet and exceed your purity expectations when looking at regulatory standards for bioprocess and biologicals manufacturing. It exhibits low extractables, low protein binding, and low gas permeability characteristics. Puri-Flex complies with the requirements of USP Class VI, FDA 21 CFR 177.2600 and 21 CFR 177.1810, RoHs compliance, REACH compliance, ADF, ISO 10993-4 and 10993-5. The tubing can easily be welded or heat sealed. Puri-Flex can be sterilized by autoclave to 135°C standard, EtO and gamma up to 45 kGy.

### C-Flex® ULTRA Pump Tubing ..... page 21

C-Flex ULTRA tubing is notably advanced when compared to the previous generations of C-FLEX. It offers five to ten times the pump life with much lower spallation. The lower spallation virtually eliminates the buildup of residue on the pump head rollers. C-Flex ULTRA offers the excellent chemical compatibility of an SBS-based thermoplastic elastomer formulation.

### MASTERFLEX® Exclusive Chem-Durance® Bio Pump Tubing ..... page 22

Provides excellent chemical resistance and pumping life and meets USP Class VI standards. A plasticizer-free liner helps reduce spallation. The thermoplastic outer jacket provides more durability—especially under higher pressures.

### Viton® Pump Tubing ..... page 24

For the chemical resistance of Viton combined with FDA compliance for food and beverage applications.

### PTFE Pump Tubing ..... page 22

A peristaltic pump head that uses PTFE tubing is available. PTFE tubing is chemically inert, will not absorb or leach into fluid, and can withstand pressures up to 6.8 bar (100 psi).

### High-Pressure Pump Tubing ..... pages 21, 23–24

Need to pump under pressure? Masterflex High-Pressure PharMed® BPT and Norprene® tubing (pages 49 and 117) can withstand up to 10.2 bar (150 psi) continuously. PTFE pump tubing also operates up to 6.8 bar (100 psi) (pages 50 and 116), while GORE® Style 100SC and Style 500 pump tubing exhibit long life at up to 4.1 bar (60 psi) (pages 65 to 71).

### GORE® High-Resilience Pump Tubing—Style 100SC and Style 500 ..... page 24

Offer a long life at continuous pressures—up to 4.1 bar (60 psi). Both formulations have excellent flow stability with minimal break-in period while also having the benefits of being spallation free and with low gas permeability. The Style 500 formulation has the added benefit of offering excellent chemical compatibility with many inorganic and organic chemicals. These tubing formulations are specifically targeted at industrial applications.

### GORE® High-Resilience Pump Tubing—Style 400 ..... page 24

A unique composite of expanded PTFE (EPTFE) and Viton® type F fluoroelastomer (FKM), making it resistant to a wide range of chemistries. Multilayer construction enables tubing to maintain a stable flow rate for hundreds of hours while pumping aggressive media. Resistant to aromatic hydrocarbons, alcohols (including methanol), steam, and concentrated acids. Primarily for industrial applications, it is designed for long life up to 4.1 bar (60 psi) continuously.

### Quick-Coupling Sanitary Pump Tubing Sets pages 72 and 129

This tubing features smooth, premolded sanitary mini-connections that provide enhanced, bacteria-free fluid transfer and allow quick connection to an adapter or to another length of sanitary tubing with similar premolded ends. See page 72 for L/S® and page 129 for I/P® sanitary tubing.

### Bulk Pump Tubing and Custom Orders ..... pages 73 and 130

Spooled and bulk-packed tubing save you money, time and waste, while giving you the added convenience of having enough tubing on hand at all times. Need a large volume of tubing? Contact us and we'll custom package Masterflex tubing to meet your needs.

### CHOOSE MASTERFLEX TUBING

**The right pump tubing is crucial when building your Masterflex pump system.** Before you choose, consider all aspects of your application: chemical compatibility, operating temperature, pressure, necessary regulatory approvals, gas permeability of the tubing, and cleaning/sterilization requirements.

#### Reference information:

For specific information on chemical compatibility with Masterflex tubing, go to pages 30–31

For our interactive chemical compatibility charts for pump tubing, go to [ColeParmer.com/MflexChem](http://ColeParmer.com/MflexChem)

For information on material life, gas permeability, pressure/vacuum/suction generation, and viscosity handling characteristics, go to [Masterflex.com](http://Masterflex.com)

## MASTERFLEX® PUMP TUBING FORMULATION DESCRIPTIONS

### SILICONE TUBING

While our silicone tubing formulations share many characteristics, there are some basic differences.

### PLATINUM-CURED SILICONE TUBING

- ▶ Slightly greater clarity
- ▶ Smooth surface; lower protein binding levels
- ▶ Fewer potential leachables
- ▶ Ideal for pharmaceutical and biotechnology use

### PEROXIDE-CURED SILICONE TUBING

- ▶ Greater physical compression capability
- ▶ Economical, longer tubing life
- ▶ Potential outgassing of peroxide products

### BIOPHARM SILICONE TUBING (PLATINUM-CURED)

- ▶ Ultra-smooth inner surface minimizes particle entrapment
- ▶ Very low extractables, with documented biocompatibility for sensitive applications
- ▶ Ideal for lab, biotech, and pharmaceutical applications

### BIOPHARM PLUS SILICONE TUBING (PLATINUM-CURED)

- ▶ All of the benefits of BioPharm silicone tubing (at left), plus:
- ▶ Longest tubing life of any silicone pump tubing
- ▶ Lower spallation than regular silicone
- ▶ Enhanced pressure capability
- ▶ Exceptional flow stability and dispense accuracy

### TO STERILIZE ALL SILICONE TUBING:

**High-speed instrument (flash) autoclave:** Place tubing on nonlinting cloth or sterilizing paper in a clean, open tray for 10 minutes at 132°C (270°F) at 2 kg/cm<sup>2</sup> (30 psi).

**Standard gravity autoclave:** Wrap tubing in nonlinting cloth or sterilizing paper and place in a clean, open tray for 30 minutes at 121°C (250°F) at 1 kg/cm<sup>2</sup> (15 psi).

**Prevacuum high-temperature autoclave:** Wrap tubing in nonlinting cloth or sterilizing paper and place in a clean, open tray for normal cycle of 30 to 35 minutes at 121°C (250°F).

**Gamma radiation:** 5.0 Mrad.

Pump tubing formulation		Silicone (platinum-cured)	Silicone (peroxide-cured)	MASTERFLEX® Exclusive BioPharm Silicone (platinum-cured)	MASTERFLEX® Exclusive BioPharm Plus Silicone (platinum-cured)
Series number		96410 and 96510	96400 and 96406	96420 and 96421	96440 and 96441
<b>Advantages</b>		Excellent biocompatibility. No leachable additives, DOP, or plasticizers; phthalate and latex-free; odorless and nontoxic, fungus-resistant. No taste imparted to transported fluids. Extremely good over a wide temperature range. Weather, ozone, corona, and radiation resistant. Minimal tendency to take a set.	Excellent biocompatibility. No additives, plasticizers or DOP; odorless and nontoxic, fungus-resistant. No taste imparted to transported fluids. Extremely good at low temperatures. Weather, ozone, corona, and radiation resistant. Minimal tendency to take a set.	Ultra-smooth inner surface minimizes particle entrapment. Lower absorption; excellent biocompatibility; no leachable additive, DOP, or plasticizers. Very low extractables. Odorless and nontoxic, fungus-resistant. No taste imparted to transported fluids. Weather, ozone, corona, and radiation resistant.	Similar to BioPharm Silicone, plus: Longest life of any silicone pump tubing. Lower spallation than regular silicone. Enhanced pressure capability. Fungus-resistant. Nontoxic, no leachable plasticizers. Lower gas permeability than other silicones. Use with many acids and alkalis.
<b>Limitations</b>		Do not use with concentrated acids and bases, organic solvents, or oils. Relatively high gas permeability.	Do not use with concentrated solvents, oils, acids. Relatively high gas permeability.	Do not use with concentrated solvents, oils, or acids. Relatively high gas permeability.	Do not use with concentrated solvents, oils, or acids. Relatively high gas permeability.
<b>Application suitability:</b>					
Acids		Not recommended	Not recommended	Not recommended	Not recommended
Alkalies		Not recommended	Not recommended	Not recommended	Not recommended
Organic solvents		Not recommended	Not recommended	Not recommended	Not recommended
Pressure		Fair	Fair	Fair	Fair
Vacuum		Good	Good	Good	Good
Viscous fluids		Fair	Fair	Fair	Fair
Sterile fluids		Excellent	Excellent	Excellent	Excellent
<b>Physical characteristics and composition</b>		Thermal set rubber. Siloxane polymers and amorphous silica. Excellent compression strength. Soft material; flexible. Translucent, clear to light amber.	Thermal set rubber. Siloxane polymers and amorphous silica. Excellent compression strength. Soft material. Translucent, clear to light amber.	Thermal set rubber. Siloxane polymers and amorphous silica. Excellent compression strength. Soft material. Translucent, clear to light amber.	Thermal set rubber. Siloxane polymers and amorphous silica. Excellent compression strength. Soft material. Translucent, clear to light amber.
<b>Temperature range</b>	Static	-50 to 230°C (-58 to 446°F)	-50 to 230°C (-58 to 446°F)	-60 to 232°C (-75 to 450°F)	-60 to 232°C (-75 to 450°F)
	Dynamic (pumping)	-40 to 100°C (-40 to 212°F)	-40 to 100°C (-40 to 212°F)	-40 to 100°C (-40 to 212°F)	-40 to 100°C (-40 to 212°F)
<b>Meets classifications</b>		USP Class V Extractables Exceeds Class VI Implant European Pharmacopoeia (EP 3.2.9) FDA 21 CFR 177.2600; FDA 21 CFR 210 and 211; Exceeds 3A Sanitary cGMPs ; Reach Compliant, RoHS Compliant, ADCF Compliant	USP Class VI European Pharmacopoeia (EP 3.2.9) FDA 21 CFR 177.2600 Exceeds 3A sanitary standards Reach Compliant, RoHS Compliant, ADCF Compliant	USP Class VI European Pharmacopoeia (EP 3.2.9) FDA 21 CFR 177.2600 Exceeds 3A sanitary standards Reach Compliant, RoHS Compliant	USP Class VI European Pharmacopoeia (EP 3.2.9) FDA 21 CFR 177.2600 Exceeds 3A sanitary standards Reach Compliant, RoHS Compliant
<b>Gas permeability</b> cc x mm (cm <sup>2</sup> x sec x cm Hg) x 10 <sup>-10</sup>		CO <sub>2</sub> : 20,132 H <sub>2</sub> : 6579 O <sub>2</sub> : 7961 N <sub>2</sub> : 2763	CO <sub>2</sub> : 20,132 H <sub>2</sub> : 6579 O <sub>2</sub> : 7961 N <sub>2</sub> : 2763	CO <sub>2</sub> : 25,147 H <sub>2</sub> : — O <sub>2</sub> : 4715 N <sub>2</sub> : 2284	CO <sub>2</sub> : 25,147 H <sub>2</sub> : — O <sub>2</sub> : 4715 N <sub>2</sub> : 2284
<b>Cleaning/sterilization</b>		Clean with hot water/soap solution; use a non-oily soap such as Ivory®, not synthetic detergent or oil-based soap as they may be absorbed by the tubing and into the fluid. Rinse well with distilled water. Ethylene oxide (EtO) sterilization is not recommended—sufficient data is not available about complete outgassing of residual EtO and other EtO products.	Clean with isopropyl alcohol or hot water/soap solution; use a non-oily soap such as Ivory®, not synthetic detergent or oil-based soap as they may be absorbed by the tubing and into the fluid. Rinse thoroughly with distilled water. May use EtO. Autoclavable.	Sterilize by EtO, autoclave, or gamma radiation up to 5.0 Mrad. To autoclave: coil loosely in nonlinting cloth or paper; autoclave at 121°C (250°F), 1 bar (15 psi) for 30 minutes.	Sterilize by EtO, autoclave, or gamma radiation up to 5.0 Mrad. To autoclave: coil loosely in nonlinting cloth or paper; autoclave at 121°C (250°F), 1 bar (15 psi) for 30 minutes.



## OTHER BIOPHARMACEUTICAL TUBING

In addition to silicone, we also carry other pump tubing formulations that are biocompatible and well-suited to biotech and pharmaceutical laboratory or production applications.

### PURI-FLEX™ TUBING

- ▶ Heat sealable and weldable
- ▶ Long pump life when compared to silicone or many other TPE tubings
- ▶ Low spallation when compared to silicone or many other TPE tubings

### C-FLEX® TUBING

- ▶ Combines biocompatibility of silicone with chemical resistance similar to Tygon®
- ▶ Heat sealable, weldable, economical





### C-FLEX® ULTRA TUBING

- ▶ Combines biocompatibility of silicone with chemical resistance similar to Tygon®
- ▶ Heat sealable, weldable, economical
- ▶ Longest pump life of any C-FLEX formulation
- ▶ Low spallation and reduced residue
- ▶ Engineered specifically for peristaltic pumps

### PHARMED® BPT TUBING

- ▶ Up to 10,000 hours of tubing life
- ▶ Resists ozone and UV radiation
- ▶ Noncytotoxic and nonhemolytic
- ▶ Ideal for tissue and cell culture work
- ▶ Heat sealable and bondable

### MASTERFLEX® Exclusive

Pump tubing formulation	Puri-Flex™	C-Flex®	C-Flex® ULTRA	PharMed® BPT
Series number	96419	06424	06434	06508
				
Advantages	Biocompatible. Heat sealable and weldable. Long pump life when compared to silicone or other TPE tubings. Low spallation when compared to silicone or some other TPE tubings. Very low protein binding. Cost effective. No halogens or phthalates.	Physical properties similar to silicone with chemical compatibility of Tygon®. Inexpensive. Biocompatible. Heat sealable and weldable.	Physical properties similar to silicone with chemical compatibility of Tygon®. Biocompatible. Heat sealable and weldable. Longer pump life and lower spallation than C-FLEX (06424).	Great for tissue and cell work—nontoxic and nonhemolytic. Long service life minimizes risk of fluid exposure; reduces tubing costs and pump downtime. Opaque to UV and visible light to protect light-sensitive fluids. Low gas permeability. High-pressure 10.3 bar (150 psi) version available.
Limitations	Do not use with concentrated solvents, oils, or acids. Moderate temperature range.	Not recommended for use with hydrocarbons. Moderate pumping life.	Not recommended for use with hydrocarbons.	Potential leaching of USP mineral oil or blend material.
Application suitability:				
Acids	Good	Good	Good	Good
Alkalies	Good	Good	Good	Good
Organic solvents	Not recommended	Not recommended	Not recommended	Not recommended
Pressure	Good	Fair	Fair	Good
Vacuum	Good	Good	Good	Good
Viscous fluids	Excellent	Fair	Fair	Excellent
Sterile fluids	Excellent	Excellent	Excellent	Excellent
Physical characteristics and composition	Thermoplastic elastomers. Excellent tensile and tear strength. Translucent, clear to light white.	Thermoplastic elastomer. Styrene-ethylene-butylene modified block copolymer with silicone oil. Excellent tensile and tear strength Soft material. Opaque, white.	Thermoplastic elastomer. Styrene-ethylene-butylene modified block copolymer with silicone oil. Excellent tensile and tear strength Translucent.	Thermoplastic elastomer. Polypropylene-based material with USP mineral oil. Excellent tensile strength. Firm (stiff) material. Opaque, beige.
Temperature range	Static	-50 to 135°C (-58 to 275°F)	-60 to 121°C (-76.6 to 250°F)	-51 to 132°C (-60 to 270°F)
	Dynamic (pumping)	-30 to 80°C (-22 to 176°F)	-40 to 60°C (-40 to 140°F)	-20 to 80°C (-4 to 176°F)
Meets classifications	USP Class VI FDA 21 CFR 177.2600 and 177.1810 Reach Compliant RoHS Compliant ADCF Compliant	USP Class VI European Pharmacopoeia (EP 3.2.9) FDA 21 CFR 177.2600 Reach Compliant, RoHS Compliant, ADCF Compliant	USP Class VI European Pharmacopoeia (EP 3.2.9) Reach Compliant, RoHS Compliant, ADCF Compliant	USP Class VI European Pharmacopoeia (EP 3.2.9) FDA 21 CFR 177.2600 NSF-51 Reach Compliant, RoHS Compliant
Gas permeability cc x mm (cm <sup>2</sup> x sec x cm Hg) x 10 <sup>-10</sup>	CO <sub>2</sub> : 1200 H <sub>2</sub> : — O <sub>2</sub> : 200 N <sub>2</sub> : 80	CO <sub>2</sub> : — H <sub>2</sub> : — O <sub>2</sub> : 150 N <sub>2</sub> : —	CO <sub>2</sub> : 2.1 H <sub>2</sub> : — O <sub>2</sub> : 1.1 N <sub>2</sub> : 3.4	CO <sub>2</sub> : 1200 H <sub>2</sub> : — O <sub>2</sub> : 200 N <sub>2</sub> : 80
Cleaning/sterilization	Sterilize by EtO, autoclave up to 135°C (275°F), gamma radiation up to 4.5 Mrad. To autoclave: coil loosely in nonlinting cloth or paper; autoclave from 121°C (250°F) to 135°C (275°F).	Sterilize by EtO, autoclave, or gamma radiation. To autoclave: do not clamp; autoclave up to maximum steam temperature of 132°C (290°F) for up to 10 minutes. Flush autoclaving at 135°C (275°F) is not recommended.	Sterilize by gamma radiation or one cycle of autoclave at 121°C (250°F), 1 bar (15 psi) for 30 minutes.	Sterilize by EtO, autoclave, or gamma radiation up to 2.5 Mrad. Repeated autoclaving will not affect overall life.

## MASTERFLEX® PUMP TUBING FORMULATIONS DESCRIPTIONS

### PHARMAPURE® TUBING

- ▶ Biocompatibility similar to PharMed® BPT
- ▶ Long life under continuous pressure up to 2.7 bar (40 psi)
- ▶ Very low spallation and low extractables

### CHEM-DURANCE® BIO TUBING

- ▶ Excellent chemical resistance
- ▶ Excellent pumping life
- ▶ Low spallation
- ▶ USP Class VI specifications
- ▶ Masterflex exclusive

### PTFE TUBING

- ▶ Chemically inert; best chemical resistance of any pump tubing
- ▶ Sold in molded pump tubing elements
- ▶ Use with PTFE tubing pump head

### TYGON® E-LFL TUBING

- ▶ Longest tubing life of all Tygon tubing formulations
- ▶ Broad chemical compatibility
- ▶ Low gas permeability

### TYGON® E-FOOD TUBING

- ▶ Meets various food and sanitary regulations
- ▶ Unaffected by common commercial sanitizers
- ▶ Nonwetting properties allow flush-cleaning and complete drainage
- ▶ Smooth inner surface





### STERILIZATION

**Ethylene oxide (ETO):** Coil tubing loosely in nonlinting cloth or sterilization paper. Follow the sterilization equipment manufacturer's directions as to gas type, concentration, times, and temperatures; maintain humidity within the prescribed limits, generally between 30 to 65%.

**Standard gravity autoclave:** Coil tubing loosely in nonlinting cloth or sterilizing paper, and place in a clean, open tray for 30 minutes at 121°C (250°F) at 1 kg/cm<sup>2</sup> (15 psi); air dry at max 66°C (150°F) for 2 to 2½ hours until clear.

**Gamma radiation:** Cap ends of tubing if required. Radiation should be product specific and according to GMP guidelines.

### MASTERFLEX® Exclusive

Pump tubing formulation	PharmaPure®	Chem-Durance® Bio	PTFE	Tygon® E-LFL	Tygon® E-Food (B-44-4X)	
Series number	06435	06442	77390	06440	06418	
						
Advantages	Nontoxic and nonhemolytic (similar to PharMed® BPT); biocompatible. Long life even under pressure; up to 1000 hours at 2.7 bar (40 psi). Very low spallation—protects fluid purity. Low extractables. Low gas permeability.	Excellent chemical resistance. Excellent life and durability under pressure. Low spallation. Plasticizer-free inner liner. High dielectric constant. Excellent biocompatibility.	Chemically inert. Excellent chemical resistance. Will not leach into or absorb out of fluid being pumped. Extremely low gas permeability. Nontoxic. Virtually nonporous. Low coefficient of friction.	Longest life of all Tygon® peristaltic tubing (up to 1000 hrs). Clear for easy flow monitoring. Broad chemical resistance. Nonaging, nonoxidizing. Low gas permeability. Smooth bore. Good for viscous fluids. High dielectric constant.	Designed especially for handling food products. Bore is extremely smooth (better than most stainless steels) Nontoxic, will not affect taste or odor, and clear for CIP and flow verification. Excellent nonwetting properties permit flush cleaning and complete drainage. High dielectric constant.	
Limitations	Potential leaching of USP mineral oil or blend material.	Requires high starting torque.	Limited pumping life. Sold as tube elements only; no continuous lengths available.	Do not use with strong acids and alkalis.	Limited pumping life.	
Application suitability:						
Acids	Good	Excellent	Excellent	Good	Good	
Alkalies	Good	Excellent	Excellent	Good	Good	
Organic solvents	Not recommended	Good	Excellent	Not recommended	Not recommended	
Pressure	Good	Excellent	Good	Good	Good	
Vacuum	Good	Excellent	Good	Good	Good	
Viscous fluids	Excellent	Excellent	Excellent	Excellent	Excellent	
Sterile fluids	Excellent	Excellent	Good	Good	Fair	
Physical characteristics and composition	Thermoplastic elastomer. Polypropylene-based material with USP mineral oil. Excellent tensile strength. Firm (stiff) material. Opaque, off-white.	Thermoplastic elastomer (for outer jacket). Plasticizer-free inner liner. Firm (stiff) material. Opaque, beige.	Polytetrafluoroethylene. Rigid material. Translucent, white.	Thermoplastic. PVC-based material with plasticizer. Firm (stiff) material. Transparent, clear.	Thermoplastic. PVC-based material with plasticizer. Firm (stiff) material. Transparent, clear.	
Temperature range	Static	-51 to 132°C (-60 to 270°F)	-60 to 74°C (-71 to 165°F)	-240 to 260°C (-400 to 500°F)	-46 to 74°C (-51 to 165°F)	-36 to 74°C (-32 to 165°F)
	Dynamic (pumping)	-20 to 80°C (-4 to 176°F)	0 to 40°C (32 to 104°F)	-40 to 150°C (-40 to 302°F)	0 to 40°C (32 to 104°F)	0 to 40°C (32 to 104°F)
Meets classifications	USP Class VI FDA 21 CFR 177.2600 European Pharmacopoeia (EP 3.2.9) Reach Compliant RoHS Compliant	USP Class VI FDA 21 CFR 177.2600 Reach Compliant RoHS Compliant	USP Class VI Reach (non-DEHP) ADCF RoHS	USP Class VI European Pharmacopoeia 3.2.9 FDA 21 CFR 175.300 EU Food Reach (non-DEHP) RoHS, ADCF	FDA 21 CFR 175.300 EU Food NSF-51 Reach (non-DEHP) RoHS ADCF 3A	
Gas permeability cc x mm (cm <sup>2</sup> x sec x cm Hg) x 10 <sup>-10</sup>	CO <sub>2</sub> : 1200 H <sub>2</sub> : — O <sub>2</sub> : 200 N <sub>2</sub> : 80	CO <sub>2</sub> : 745 H <sub>2</sub> : — O <sub>2</sub> : 200 N <sub>2</sub> : 80	CO <sub>2</sub> : 6.8 H <sub>2</sub> : — O <sub>2</sub> : — N <sub>2</sub> : 1.0	CO <sub>2</sub> : 563 H <sub>2</sub> : — O <sub>2</sub> : 124 N <sub>2</sub> : 67	CO <sub>2</sub> : 270 H <sub>2</sub> : 97 O <sub>2</sub> : 60 N <sub>2</sub> : 30	
Cleaning/sterilization	Sterilize by EtO, autoclave or gamma radiation up to 2.5 Mrad. Repeated autoclaving will not affect overall life.	Sterilize with ethylene oxide (EtO) radiation or autoclave. To autoclave: Coil loosely in nonlinting cloth or paper, autoclave at 121°C (250°F) 1 kg/cm <sup>2</sup> (15 psi) for 30 minutes; air dry at 66°C (150°F) for 2 to 2½ hours. Radiation: 2.5 Mrads.	Sterilize by EtO, autoclave or dry heat.	Sterilize with EtO or autoclave. To autoclave: Coil tubing loosely in nonlinting cloth or paper, autoclave at 121°C (250°F), 1 kg/cm <sup>2</sup> (15 psi) for 30 minutes (tubing will appear milky); air dry at max 66°C (150°F) for 2 to 2½ hours until clear.	Unaffected by commercial sanitizers (with recommended procedures). Sterilize by EtO or autoclave. To autoclave: Coil tubing loosely in nonlinting cloth or paper; autoclave at 121°C (250°F), 1 kg/cm <sup>2</sup> (15 psi) for 30 minutes (tubing will appear milky); air dry at max 66°C (150°F) for 2 to 2½ hours until clear.	





## OTHER INDUSTRIAL AND FOOD-GRADE TUBING

### TYGON® E-LAB TUBING

- ▶ Ideal for general transfer applications
- ▶ Economical
- ▶ Nontoxic, nonaging, and nonoxidizing

### TYGON® FUEL & LUBRICANT TUBING

- ▶ Ideal for transferring hydrocarbons, gasoline, kerosene, heating oils, cutting compounds, and glycol-based coolants
- ▶ Not for use with concentrated strong acids or alkalies

### TYGON® CHEMICAL TUBING

- ▶ Best chemical resistance of Tygon formulations
- ▶ Compatible with some organics
- ▶ Plasticizer-free

### NORPRENE® TUBING

- ▶ Up to 10,000 hours of tubing life
- ▶ Best choice for pressure/vacuum applications
- ▶ Resists heat, ozone, acids, and alkalies
- ▶ Heat sealable and bondable
- ▶ Nonaging, nonoxidizing

### NORPRENE® FOOD TUBING

- ▶ Ideal for high-temperature food and beverage applications
- ▶ Similar characteristics as Norprene® tubing
- ▶ Meets FDA and NSF standards

### WHERE TO ORDER TUBING

C/L® TUBING .....	33
L/S® TUBING .....	68-73
I/P® TUBING .....	126-130
B/T® TUBING .....	153

Pump tubing formulation	Tygon® E-Lab (E-3603)	Tygon® Fuel & Lubricant (F-4040-A)	Tygon® Chemical (2001)	Norprene® (A 60 G)	Norprene® Food (A 60 F)
Series number	06509	06401	06475	06404	06402
<b>Advantages</b>	Inexpensive tubing for general laboratory applications. Clear for easy flow monitoring. Handles virtually all inorganic chemicals. Nonaging, nonoxidizing. Low gas permeability. Good for viscous fluids. High dielectric constant.	Specially formulated to transport hydrocarbons, petroleum products, and distillates. Suitable for gasoline, kerosene, heating oils, cutting fluids, and glycol-based coolants. Minimum extractability. Low gas permeability. High dielectric constant.	Best chemical resistance of any Tygon® formulation. Compatible with many polar solvents. Plasticizer-free. Clear for easy flow monitoring. Low extractability. Low gas permeability. High dielectric constant.	Best choice for vacuum/pressure applications. Offers longest pump tubing life. Heat, ambient ozone resistant. Good resistance to acids/alkalies. Black color hides dirt and dust. Heat sealable, nonaging, and nonoxidizing. High dielectric constant. High-pressure version available.	Similar to Norprene® (06404) but with FDA approval. Excellent for food/dairy applications. Longest life, good flow consistency. Heat and ozone resistant. Good resistance to acids/alkalies. Heat sealable, nonaging, and nonoxidizing. High dielectric constant.
<b>Limitations</b>	Limited pumping life.	Don't use with strong acids and alkalies.	Limited pumping life. Some external spallation during use (does not affect tubing ID). Recommended for use with Easy-Load®, Easy-Load® II, and Easy-Load® 3 pump heads only.	Potential leaching of USP mineral oil or blend material.	Potential leaching of USP mineral oil or blend material.
<b>Application suitability:</b>					
Acids	Good	Good	Excellent	Good	Good
Alkalies	Good	Good	Excellent	Good	Good
Organic solvents	Not recommended	Not recommended	Good	Not recommended	Not recommended
Pressure	Good	Good	Good	Excellent	Excellent
Vacuum	Good	Good	Good	Excellent	Excellent
Viscous fluids	Excellent	Excellent	Excellent	Excellent	Excellent
Sterile fluids	Poor	Poor	Good	Not recommended	Good
<b>Physical characteristics and composition</b>	Thermoplastic. PVC-based material with plasticizer. Firm (stiff) material. Transparent, clear.	Thermoplastic. PVC-based material with plasticizer. Firm (stiff) material. Transparent, yellow.	Thermoplastic elastomer. PVC- and plasticizer-free material. Firm (stiff) material. Transparent, clear.	Thermoplastic elastomer. Polypropylene-based material with USP mineral oil. Excellent tensile strength. Firm (stiff) material. Opaque, black.	Thermoplastic elastomer. Polypropylene-based material with USP mineral oil. Excellent tensile strength. Firm (stiff) material. Opaque, beige.
<b>Temperature range</b>	-46 to 74°C (-51 to 165°F) 0 to 40°C (32 to 104°F)	-37 to 74°C (-35 to 165°F) 0 to 40°C (32 to 104°F)	-77 to 57°C (-108 to 135°F) 0 to 40°C (32 to 104°F)	-59 to 132°C (-60 to 270°F) -20 to 80°C (-4 to 176°F)	-59 to 132°C (-60 to 270°F) -20 to 80°C (-4 to 176°F)
<b>Meets classifications</b>	USP Class VI FDA 21 CFR 175.300 EU Food NSF-51 Reach (non-DEHP) RoHS ADCF	None Reach Compliant RoHS Compliant ADCF Compliant	FDA 21 CFR 175.300 Reach Compliant RoHS Compliant ADCF Compliant	NSF-51 Reach Compliant RoHS Compliant =	FDA 21 CFR 177.2600 NSF-51 Reach Compliant RoHS Compliant
<b>Gas permeability</b> cc x mm (cm <sup>2</sup> x sec x cm Hg) x 10 <sup>-10</sup>	CO <sub>2</sub> : 360 H <sub>2</sub> : 97 O <sub>2</sub> : 80 N <sub>2</sub> : 40	CO <sub>2</sub> : 100 H <sub>2</sub> : 97 O <sub>2</sub> : 22 N <sub>2</sub> : 12	CO <sub>2</sub> : 114 H <sub>2</sub> : — O <sub>2</sub> : 19 N <sub>2</sub> : 9	CO <sub>2</sub> : 1200 H <sub>2</sub> : — O <sub>2</sub> : 200 N <sub>2</sub> : 80	CO <sub>2</sub> : 1200 H <sub>2</sub> : — O <sub>2</sub> : 200 N <sub>2</sub> : 80
<b>Cleaning/sterilization</b>	Sterilize with EtO or autoclave. To autoclave: Coil tubing loosely in nonflinting cloth or paper, autoclave at 121°C (250°F), 1 kg/cm <sup>2</sup> (15 psi) for 30 minutes (tubing will appear milky); air dry at max 66°C (150°F) for 2 to 2½ hours until clear.	Sterilization is not recommended.	Sterilize by EtO, autoclave, or gamma radiation. To autoclave: Coil tubing loosely in nonflinting cloth or paper; autoclave at 121°C (250°F), 1 kg/cm <sup>2</sup> (15 psi) for 30 minutes (tubing will appear milky); air dry at max 66°C (150°F) for 2 to 2½ hours until clear.	Sterilize by autoclave, EtO, and gamma. Repeated sterilization will not affect overall life.	Sterilize by autoclave, EtO, and gamma. Repeated autoclaving will not affect overall life.



## OTHER INDUSTRIAL AND FOOD-GRADE TUBING

### Gore® High-Resilience Tubing, Style 100SC

- ▶ Long life at continuous pressure up to 4 bar (60 psi)
- ▶ Excellent flow stability
- ▶ Spallation-free
- ▶ Low gas permeability

### Gore® High-Resilience Tubing, Style 500

- ▶ Very similar to Style 100SC, plus:
- ▶ Excellent chemical resistance
- ▶ Compatible with many inorganic and organic chemicals

### Gore® High-Resilience Tubing, Style 400

- ▶ Long life under pressure
- ▶ Minimal break-in period
- ▶ Excellent chemical compatibility
- ▶ Ideal for industrial applications

### Viton® Tubing

- ▶ Excellent chemical resistance
- ▶ Resists corrosives, solvents, and oils at elevated temperatures

### WHERE TO ORDER TUBING

C/L® TUBING .....	33
L/S® TUBING .....	68-73
I/P® TUBING .....	126-130
B/T® TUBING .....	153

Pump tubing formulation	GORE® Style 100SC	GORE® Style 500	GORE® Style 400	Viton®
Series number	96190	96191	06439	96412
Advantages	Long life, even under pressures up to 4 bar (60 psi). Excellent flow stability; <1% change in flow rate as tubing wears. No break-in period required. Spallation-free. Excellent biocompatibility. Low extractables.	Similar to STA-PURE® PCS tubing but with enhanced chemical resistance. Resistant to many organic and inorganic fluids. Long life at pressure up to 60 psi (4 bar). Spallation-free. Excellent biocompatibility. Low gas permeability.	Long life under pressure. Excellent tubing life. Minimal break-in period. Spallation-free. Excellent chemical compatibility. Ideal for industrial applications.	Perfect for food and lab applications where FDA compliance is required. Excellent chemical resistance. Resistant to corrosives, solvents, and oils at elevated temperatures. Low gas permeability.
Limitations	Sold as tube elements only; no continuous lengths available.	Sold as tube elements only; no continuous lengths available.	Does not meet either USP or FDA classifications. Limited temperature range. Sold as tube elements only. No continuous lengths available.	Limited pumping life.
Application suitability:				
Acids	Not recommended	Excellent	Excellent	Excellent
Alkalies	Not recommended	Good	Excellent	Excellent
Organic solvents	Not recommended	Excellent	Variable—test before using	Variable—test before using
Pressure	Excellent	Excellent	Excellent	Good
Vacuum	Good	Good	Good	Good
Viscous fluids	Good	Good	Good	Good
Sterile fluids	Excellent	Excellent	Not recommended	Fair
Physical characteristics and composition	ePTFE (expanded PTFE) and platinum-cured silicone. Excellent tensile strength. Firm (stiff) material. Opaque, white.	ePTFE (expanded PTFE) and fluoroelastomer. Excellent tensile strength. Firm (stiff) material. Opaque, white.	ePTFE and Viton® type F fluoroelastomer (FKM). Excellent tensile and tear strength. Opaque, beige.	Thermal set rubber. Viton B (67% fluorine). Firm (stiff) material. Opaque, black.
Temperature range	Static	-40 to 150°C (-40 to 302°F)	-80 to 200°C (-112 to 392°F)	0 to 200°C (52 to 390°F)
	Dynamic (pumping)	-40 to 150°C (-40 to 302°F)	-40 to 150°C (-40 to 302°F)	0 to 150°C (32 to 302°F)
Meets classifications	RoHS Compliant REACH Compliant	RoHS Compliant REACH Compliant	RoHS Compliant	FDA 21 CFR 177.2600 ADCF Compliant
Gas permeability cc x mm (cm <sup>2</sup> x sec x cm Hg) x 10 <sup>-10</sup>	CO <sub>2</sub> : 20,132 H <sub>2</sub> : 6579 O <sub>2</sub> : 7961 N <sub>2</sub> : 2763	CO <sub>2</sub> : 76 to 79 H <sub>2</sub> : — O <sub>2</sub> : — N <sub>2</sub> : 4.3	CO <sub>2</sub> : 77 H <sub>2</sub> : — O <sub>2</sub> : 14 N <sub>2</sub> : 4.3	CO <sub>2</sub> : 76 to 79 H <sub>2</sub> : — O <sub>2</sub> : 13 to 15 N <sub>2</sub> : 4.3
Cleaning/sterilization	N/A: For industrial use only	N/A: For industrial use only	N/A: For industrial use only.	—

# MASTERFLEX<sup>®</sup>

**NEW**

## Masterflex<sup>®</sup> Tygon<sup>®</sup> Non-DEHP Peristaltic Pump Tubing

- All formulations now made with a bio-based and fully biodegradable plasticizer
- No BPA or phthalates—REACH compliant, environmentally responsible, and safer for products, people, and the planet
- Available in most Masterflex sizes to ensure the best performance when used with Masterflex peristaltic pumps



### Tygon<sup>®</sup> E-LFL (Long Flex Life) Pump Tubing

As the successor to Tygon LFL, this new formulation offers the best peristaltic pump life of any clear Tygon tubing. It has been tested for up to 1000 hours at 0 psi and 150 hours at 25 psi. This non-DEHP tubing is perfect for laboratory, food & beverage, and biopharmaceutical applications. Safe and nontoxic, it can be sterilized via ethylene oxide gas or autoclave. Complies with USP Class VI, EP 3.2.9, ISO 10993, EU Food 10/2011, and FDA requirements.



### Tygon<sup>®</sup> E-Food (B-44-4X) Pump Tubing

The new Tygon E-Food tubing is one of the first to offer a near global approval for the food, beverage, and sanitary industries. This new non-DEHP formulation offers a significantly better pump life—second only to E-LFL for the clear Tygon formulations. Smooth nonporous bore will not trap particles or promote bacterial growth. Compatible with foods containing high oil content. Resistant to harsh cleaners, sanitizers, and can be sterilized via ethylene oxide gas and autoclave. Complies with FDA, 3-A, EU Food 10/2011, and NSF 51 standards.



### Tygon<sup>®</sup> E-Lab (E-3603) Laboratory Pump Tubing

Tygon E-Lab is the next generation of the successful Lab (R-3603) tubing, bringing together clarity, flexibility, crack-resistance, affordability, and now environmental-friendliness. Tygon E-Lab is designed for general laboratory work with peristaltic pumps and analytical instruments. It offers a wide range of chemical compatibility, and can be sterilized by ethylene oxide gas and autoclave.

## TUBING HIGHLIGHTS

### MASTERFLEX® PURI-FLEX™ PUMP TUBING



#### FEATURES/BENEFITS

- ▶ Significantly longer pump life than silicone formulations
- ▶ No phthalate plasticizers or DEHP additives
- ▶ Ultralow extractable and leachables
- ▶ Autoclave to higher 135°C (275°F) standard
- ▶ Weldable/sealable
- ▶ Animal-derived component free (ADCF)

#### APPLICATIONS

- ▶ Cell and tissue culture and fermentation work
- ▶ Pharmaceutical
- ▶ Biotech
- ▶ High-purity requirements
- ▶ General-purpose lab
- ▶ Sterile filling and dispensing systems

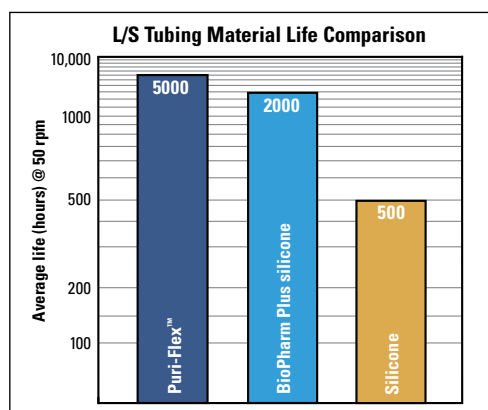

### MASTERFLEX® C-FLEX® ULTRA PUMP TUBING



#### FEATURES/BENEFITS

- ▶ Complies with USP 24/NF19 Class VI
  - ▶ Chemically resistant to concentrated acids and alkalis
  - ▶ Significantly less permeable than silicone
  - ▶ Flexible over wide temperature range of -45 to 135°C (-50 to 275°F)
  - ▶ Very low spallation
  - ▶ Exceptional pump life
  - ▶ Runs clean with minimal residue
  - ▶ Excellent clarity
  - ▶ Sealable and weldable
  - ▶ Available in all MasterFlex sizes
  - ▶ Easily integrated in custom configurations
- C-Flex® ULTRA is a unique, proprietary thermoplastic elastomer specifically designed to meet the critical demands of the pharmaceutical, research, biopharmaceutical, and diagnostics industries.

#### APPLICATIONS

- ▶ Cell culture media and fermentation
- ▶ Pharmaceutical
- ▶ Vaccine production
- ▶ Research and development
- ▶ Biotech
- ▶ Medical
- ▶ Diagnostics
- ▶ High purity



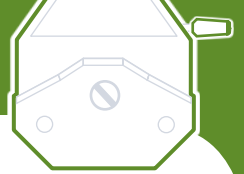

### MASTERFLEX® TYGON® E-LFL PUMP TUBING



#### FEATURES/BENEFITS

- ▶ Longest pumping life of any clear Tygon tubing—reduces process downtime
- ▶ Broad chemical resistance—excellent for laboratory applications
- ▶ Autoclavable for high-purity applications
- ▶ Extremely low particle spallation—reliable for sensitive fluid applications
- ▶ Meets USP Class VI, ISO 10993 and FDA criteria—suitable for laboratory, food & beverage, and biopharmaceutical applications
- ▶ Contains no BPA or phthalates
- ▶ Temperature flexibility range of -46 to 74°C (-51 to 165°F)

Designed to address market concerns about phthalate content and to meet regulatory requirements, Masterflex Tygon E-LFL is the result of years of testing for chemical resistance, pumpability, and general tubing performance. Tygon E-LFL offers a global compliance certification set, including USP Class VI, European Pharmacopeia 3.2.9, FDA, European Food (10/2011/EU), Japan Food Sanitation Law #370/1959, REACH, and 1935/2004/EC.

#### APPLICATIONS

- ▶ Wide range of liquid transfer in labs
- ▶ Production filtration and fermentation
- ▶ Food & beverage and cosmetic processing
- ▶ Surfactant delivery
- ▶ Flavor and vitamin concentrate dispensing
- ▶ Printing ink transfer
- ▶ Highly viscous fluid transfer
- ▶ Drum and tank drainage
- ▶ Shear-sensitive fluid transfer

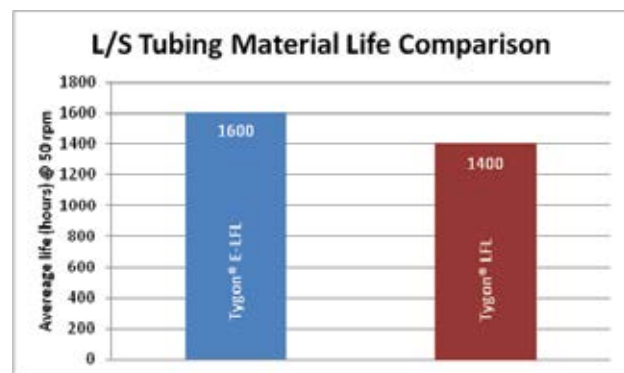

### MASTERFLEX® TYGON® E-FOOD PUMP TUBING



#### FEATURES/BENEFITS

- ▶ Smooth, nonporous bore will not trap particulates or promote bacterial growth
- ▶ Compatible with foods containing a high oil content
- ▶ Resistant to harsh alkaline cleaners and sanitizers
- ▶ Excellent alternative to rigid piping systems
- ▶ Contains no BPA or phthalates
- ▶ Temperature flexibility range of -46 to 74°C (-51 to 165°F)

Masterflex E-Food offers dramatically longer pumping life than the original Masterflex Tygon Food formulation (Tygon B-44-4X). Precision extruded for an exceptionally smooth inner bore, this tubing helps protect against costly contamination in your process lines. The formulation is compatible with most food substances and liquids, including those with high lipid content, while still standing up to cleaning and sanitizing routines. The tubing formulation has global compliance certificates—FDA, European Food (10/2011/EU), Japan Food Sanitation Law #370/1959, REACH, 3-A, NSF-51 and NSF-61.

#### APPLICATIONS

- ▶ Aseptic filling
- ▶ Condiment dispensing
- ▶ Dairy processing
- ▶ Vitamin and flavor concentrate systems
- ▶ Soft-serve dispensing

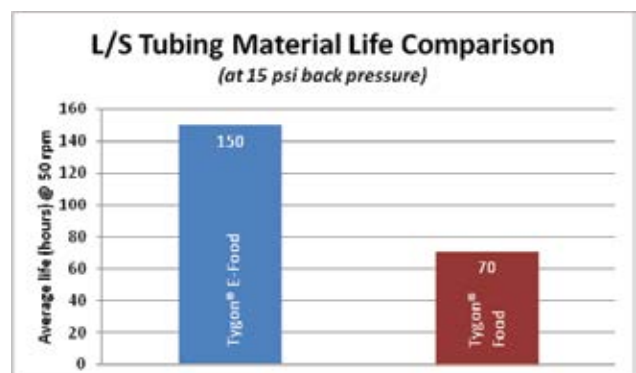

## TUBING HIGHLIGHTS

### MASTERFLEX® CHEM-DURANCE® BIO PUMP TUBING



#### FEATURES/BENEFITS

- ▶ Long flex life in peristaltic pumps
- ▶ Temperature range of -59 to 74°C (-75 to 165°F)
- ▶ Superior chemical resistance, specifically with acids, bases, salts, and ketones
- ▶ Meets FDA criteria for food contact and USP Class VI regulations
- ▶ Resists absorption/adsorption of aqueous fluids
- ▶ Virtually unaffected by chemical sanitizers and cleaners

Chem-Durance Bio features a plasticizer-free bore (inner layer) bonded to a thermoplastic elastomer jacket (outer layer) to create a tubing that combines outstanding pump life and chemical resistance. The inner bore is hydrophobic and resists absorption/adsorption of aqueous fluids to minimize the risk of fluid alteration in single- or repeat-use applications. In addition, the inner liner material reduces particulate spallation in your fluid, ensuring a cleaner process. Its outer elastomer jacket offers greater flexibility and excellent pump life. Test results show pump life of over 13,000 hours at 100 rpm and 0 psi. This unique combination of chemical-resistant inner liner and flexible outer jacket allow Chem-Durance Bio to offer better pumping life than any other similar tubing material.

#### APPLICATIONS

- ▶ Ink production
- ▶ Battery acid filling
- ▶ Specialty chemical production/processing
- ▶ Diagnostic testing
- ▶ Sensitive-fluid transfer

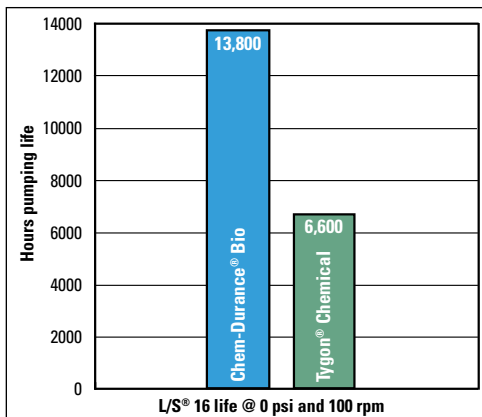

### MASTERFLEX® PHARMAPURE® PUMP TUBING



#### FEATURES/BENEFITS

- ▶ Ultra-low particulate spallation
- ▶ Outlasts silicone tubing in peristaltic pumps up to 30 times
- ▶ Provides an excellent barrier with low permeability
- ▶ Withstands autoclaving and sterilization
- ▶ Meets all USP Class VI and FDA criteria

PharmaPure tubing is a premium peristaltic pump tubing that combines unsurpassed pump life with ultra-low particle spallation. Developed especially for pharmaceutical, biotechnology, and laboratory applications, this tubing provides superior flex life; excellent wear properties; low permeability and superior adsorption characteristics as compared to silicone and other alternate materials. Recommended for use in all Masterflex L/S®, I/P®, and B/T® pump heads, except for L/S and I/P High-Performance pump heads.

#### APPLICATIONS

- ▶ Cell harvest and media process systems
- ▶ Vaccine manufacturing
- ▶ Bioreactor process lines
- ▶ Sterile filling
- ▶ Diagnostic test products
- ▶ Production filtration and fermentation



**With its superior flex life and low spallation rate, PharmaPure tubing is an ideal option in biotechnology and laboratory applications. The inner layer protects sensitive cell cultures.**

#### SPALLATION RATE TUBING COMPARISON

The following test data summarizes the spallation results of select tubing used in a peristaltic pump. In each case ¼" ID tubing was used in a three-roller pump head operating at 600 rpm under room temperature 23°C (73°F). Results from a minimum of five samples were averaged to obtain values.

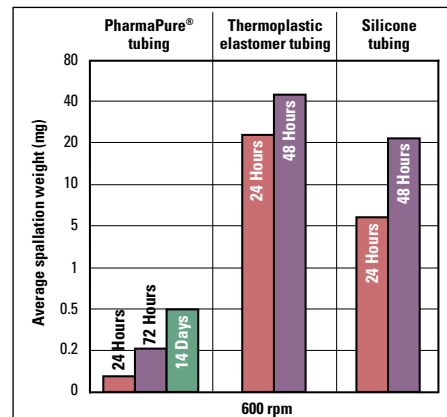

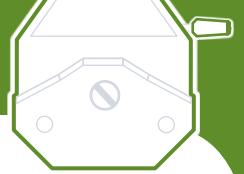

### MASTERFLEX® PLATINUM-CURED SILICONE PUMP TUBING



#### FEATURES/BENEFITS

- ▶ Excellent flexibility
- ▶ Stability over a wide temperature range
- ▶ High resiliency
- ▶ No leachable additives
- ▶ No imparted taste or odor
- ▶ No added organic plasticizers, phthalates, or latex additives
- ▶ Exceeds USP Class VI
- ▶ Meets European Pharmacopoeia 4th edition 3.1.9 requirements
- ▶ Each lot is tested for heavy metals

#### APPLICATIONS

- ▶ Media processing
- ▶ General-purpose Lab
- ▶ Vaccine manufacturing
- ▶ Sanitary sampling



### MASTERFLEX® BIOPHARM PLUS SILICONE PUMP TUBING



#### FEATURES/BENEFITS

- ▶ The shortest break-in period for pumping and the most consistent flow repeatability of any Masterflex tubing formulation
- ▶ Three times smoother than standard peroxide- or platinum-cured silicone tubing
- ▶ Ultra-smooth inner bore inhibits bacterial growth in fluid line
- ▶ Exceptional pumping life—up to 4 times longer pump life than standard silicones!
- ▶ Meets or exceeds USP, EP, 3A and FDA requirements

BioPharm Plus pump tubing is a perfect choice for any application requiring a high degree of purity, excellent repeatability, long pumping, and a combination of these. Designed to withstand pressure better than standard silicones, BioPharm Plus offers longer pumping life with ultra-low particulate spallation. Its superior flex characteristics mean less fatigue while in use, ensuring excellent repeatability in pump performance and remarkable consistent flow over the life of the tubing.

#### APPLICATIONS

- ▶ Sterile filling
- ▶ Diagnostic test product manufacturing
- ▶ Media processing
- ▶ Vaccine manufacturing
- ▶ High-accuracy drug, food and beverage repetitive dispensing

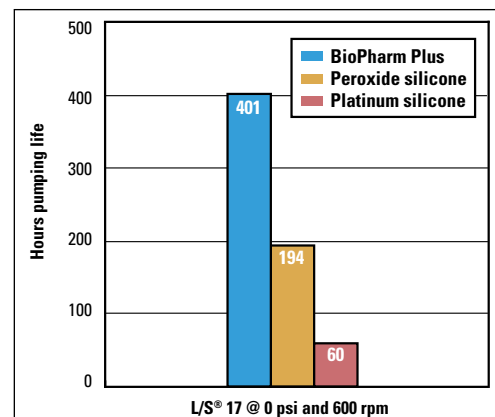

## MASTERFLEX® PUMP TUBING COMPATIBILITY CHARTS

Determine the right tubing formulation for your application using the chemical compatibility tables at right. These tables are for use with all Masterflex tubing sizes. All ratings in the tables indicate tubing condition after exposure to the chemical at 21°C (70°F).

### Ratings & Materials Legend

#### Ratings

- A:** No effect; little noticeable change
- B:** Minor effect; slight corrosion or discoloration
- C:** Moderate effect; not recommended for continuous use; softening, loss of strength, swelling and/or shrinkage
- D:** Severe effect; not recommended for use; severe softening, swelling and/or shrinkage
- :** No data available

#### Tubing formulations

- PN:** PharMed® BPT, High-Pressure PharMed® BPT, PharmaPure®, Norprene®, Norprene® Food, PuriFlex™
- CF:** C-FLEX® and C-Flex® ULTRA
- S:** Silicone (peroxide/platinum-cured), BioPharm, BioPharm Plus, GORE® Style 100SC
- T:** Tygon® E-Lab, Tygon® E-LFL, Tygon® E-Food
- TU:** Tygon® Fuel & Lubricant
- TC:** Tygon® Chemical
- CD:** Chem-Durance® Bio
- PFL:** GORE® Style 500
- V:** Viton®, GORE® Style 400
- FP:** Polytetrafluoroethylene (PTFE)

#### Pump head materials

- PSF:** Polysulfone
- PC:** Polycarbonate
- PPS:** Polyphenylene sulfide
- SS:** Stainless steel
- PP:** Polypropylene

### ⚠ DANGER

Even if tubing passes the immersion test, variations in temperature, pressure, or concentration may cause tubing failure.

#### SERIOUS INJURY MAY RESULT.

Use suitable guards and/or personal protection when pumping chemicals.

### ⚠ WARNING

The information in these tables has been supplied to Cole-Parmer by the tubing manufacturers and is to be used **ONLY** as a guide to select your tubing. Test fluids and tubing using the tubing test procedure on page 31. Cole-Parmer does not warrant (neither express or implied) that the information in these tables is accurate or complete or that any material is suitable for any purpose.

Fluid	Tubing formulation										Pump head material				
	PN	CF	S	T	TU	TC	CD	PFL	V	FP	PSF	PC	PPS	SS	PP
Acetaldehyde	D	A	B	D	D	D	C	A	D	A	D	—	A	A	A
Acetate LMW	A	A	—	D	D	C	D	—	—	A	D	—	A	A	D
Acetic acid <5%	A	A	A	D	A	B	A	A	—	A	A	A	A	B	B
Acetic acid >5%	A	A	A	B	A	B	A	A	B	A	A	C	A	B	A
Acetic anhydride	A	B	C	D	D	A	A	A	D	A	D	D	A	B	C
Acetone	D	C	C	D	D	C	B	A	D	A	D	D	A	A	A
Acetonitrile	B	A	—	D	D	B	B	—	D	A	D	D	A	A	—
Acetyl bromide	C	A	—	D	D	C	D	—	—	A	—	—	—	—	—
Acetyl chloride	C	A	C	D	D	C	D	A	A	A	D	D	A	A	D
Air	A	A	A	A	A	A	A	A	A	A <sup>†</sup>	A	A	A	A	A
Aliphatic hydrocarbons	D	D	—	D	B	D	D	—	—	—	—	—	—	B	—
Aluminum chloride	A	A	B	A	A	A	A	—	A	A	A	A	A	D	A
Aluminum sulfate	A	A	A	A	A	A	A	—	A	A	A	A	A	B	A
Alums	A	A	A	A	A	A	A	—	A	A	—	—	—	A	A
Ammonia, gas / liquid	A	A	C	B	B	B	B	—	D	A	A	D	A	B	A
Ammonium acetate	A	A	—	A	A	A	A	A	D	A	—	A	—	B	A
Ammonium carbonate	A	A	C	A	A	A	A	A	A	A	A	—	A	B	A
Ammonium chloride	A	A	C	A	A	A	A	A	A	A	A	—	A	C	A
Ammonium hydroxide	A	A	A	B	C	A	A	A	B	A	A	D	A	A	A
Ammonium nitrate	A	A	C	A	A	A	A	A	A	A	A	—	A	A	A
Ammonium phosphate	A	A	A	A	A	A	A	A	A	A	A	A	A	B	A
Ammonium sulfate	A	A	A	A	A	A	A	A	A	A	A	A	A	B	A
Amyl acetate	D	D	D	D	D	D	D	B	D	A	D	D	A	A	D
Amyl alcohol	B	D	D	D	A	A	A	A	A	A	—	—	A	A	A
Amyl chloride	C	D	D	D	D	D	D	—	A	A	D	D	D	A	D
Aniline	C	B	D	D	D	D	D	A	B	A	D	D	A	A	D
Aniline hydrochloride	C	B	D	D	D	D	D	A	B	A	—	D	—	A	D
Aqua regia	D	—	D	D	D	A	A	—	B	A	D	D	D	D	B
(80% HCl, 20% H)	D	D	—	D	D	D	D	—	A	—	—	—	—	B	—
Aromatic hydrocarbons	D	D	—	D	D	D	D	—	A	—	—	—	—	B	—
Arsenic acids	A	—	—	A	A	A	A	—	D	—	—	—	—	—	—
Barium salts	A	A	A	A	A	A	A	A	A	A	A	—	A	B	B
Benzaldehyde	D	D	B	D	D	C	C	A	D	A	C	C	A	B	C
Benzenesulfonic acid	D	A	D	D	D	D	D	A	A	A	D	D	A	B	D
Bleaching liquors	A	B	B	A	A	A	A	—	A	A	—	—	—	—	B
Boric acid	A	A	A	A	A	A	A	A	A	A	A	A	A	B	A
Bromine	D	A	D	D	D	D	D	—	A	A	—	D	D	D	C
Butane	A	D	D	A	A	B	B	A	A	A	—	—	A	A	B
Butanol (butyl alcohol)	D	B	B	D	A	A	A	A	A	A	A	C	A	A	B
Butyl acetate	B	D	D	D	D	D	D	B	D	A	D	D	A	B	D
Butyric acid	B	A	D	D	C	D	D	A	B	A	—	—	A	B	C
Calcium oxide	A	—	A	A	A	A	A	—	A	A	—	—	—	A	A
Calcium salts	A	A	B	A	A	A	A	A	A	A	A	—	A	B	A
Carbon bisulfide	D	D	D	D	D	D	D	—	—	A <sup>†</sup>	—	—	—	A	C
Carbon dioxide	A	A	B	A	A	A	A	A	A	A <sup>†</sup>	—	A	A	A	A
Carbon tetrachloride	D	B	D	D	D	D	D	B	A	A	A	D	A	B	D
Chlorine, dry	C	A	D	A	A	C	C	—	A	A <sup>†</sup>	D	—	D	A	D
Chlorine, wet	D	A	D	C	A	C	C	—	B	A	D	—	D	C	D
Chloroacetic acid	B	A	—	A	D	A	A	B	D	A	D	D	A	B	D
Chlorobenzene	D	D	D	D	D	D	D	A	B	D	D	D	A	A	D
Chlorobromomethane	B	D	D	D	D	—	D	—	A	A	D	—	—	—	A
Chloroform	C	D	D	D	D	D	D	B	A	A	D	D	A	A	D
Chlorosulfonic acid	D	A	D	D	D	D	D	A	D	A	D	—	—	D	D
Chromic acid, 30%	A	A	C	C	C	B	B	—	A	A	D	D	A	B	A
Chromium salts	A	A	—	A	A	A	A	—	—	—	—	—	—	—	—
Copper salts	A	A	A	A	A	A	A	—	A	A	—	—	A	B	A
Cresol	D	D	D	B	C	A	A	A	A	A	D	D	A	A	C
Cyclohexane	D	D	D	D	C	D	D	B	A	A	A	B	A	A	D
Cyclohexanone	D	D	D	D	D	C	C	—	D	A	D	D	A	A	D
Diacetone alcohol	A	A	B	D	D	A	A	A	D	A	—	D	—	B	C
Dimethyl formamide	B	B	B	D	D	A	A	A	D	A	D	D	A	A	A
Dimethyl Sulfoxide (DMSO)	A	—	—	—	—	—	—	—	—	A	A	C	A	A	A
Essential oils	D	B	C	D	C	D	D	—	—	—	—	—	—	—	—
Ethanol (ethyl alcohol)	C	B	A	D	B	A	A	A	A	A	B	B	A	A	A
Ether	C	D	D	D	C	D	D	B	D	A	D	D	A	A	B
Ethyl acetate	B	D	B	D	D	D	D	A	D	A	A	D	A	B	A
Ethyl bromide	D	A	D	D	D	C	D	—	A	A	—	—	—	—	D
Ethyl chloride	C	A	D	D	D	D	D	—	A	A	D	D	—	A	D
Ethylamine	D	A	C	D	D	B	B	B	D	—	—	—	—	—	—
Ethylene chlorohydrin	A	A	C	D	B	A	A	—	A	A	D	D	A	B	D
Ethylene dichloride	C	A	D	D	D	D	D	B	A	A	D	D	A	B	A
Ethylene glycol	A	B	A	A	A	A	A	A	A	A	A	C	A	B	A
Ethylene oxide	A	A	D	A	A	A	A	B	D	A	A	D	D	B	D
Fatty acids	C	B	C	B	B	C	C	A	A	A	—	C	—	B	A
Ferric chloride	A	A	B	A	A	A	A	—	A	A	A	—	A	D	A
Ferric sulfate	A	A	B	A	A	A	A	A	A	A	A	—	A	B	A
Ferrous chloride	A	A	C	A	A	A	A	—	A	A	A	D	A	D	A
Ferrous sulfate	A	A	C	A	A	A	A	A	A	A	A	A	A	B	A
Fluoboric acid	D	A	A	C	D	A	A	—	—	A	A	—	A	B	A
Fluoroborate salts	A	A	—	A	A	A	A	—	—	—	—	—	—	—	—
Fluosilicic acid	C	A	D	A	A	A	A	—	A	A	A	—	A	C	A
Formaldehyde	D	A	B	D	D	C	C	A	D	A	A	A	A	C	A
Formic acid, 25%	A	A	B	B	C	A	A	A	D	A	C	D	A	B	A
Refrigerant	D	C	—	D	D	A	A	D	—	A	—	D	A	A	—
Gasoline, high-aromatic	D	D	D	D	B	D	D	B	A	A	A	C	A	A	D
Gasoline, nonaromatic	D	D	D	D	B	D	D	B	A	A	A	C	A	A	C
Glucose	A	A	A	A	A	A	A	A	A	A	—	A	—	A	A
Glue, P.V.A.	A	A	A	A	A	A	—	A	—	A	—	—	—	A	C
Glycerin	A	B	A	A	A	A	A	—	A	A	A	A	A	A	A
Hydriodic acid	D	A	—	A	A	A	A	—	A	—	—	—	—	—	—
Hydrobromic acid, 30%	D	A	D	C	A	A	A	—	A	A	B	D	A	D	A
Hydrochloric acid (dil)	A	A	D	B	A	A	A	A	A	A	A	D	D	D	A
Hydrochloric acid (med)	B	A	D	C	D	A	A	A	A	A	A	D	D	D	A
Hydrochloric acid (conc)	—	B	D	C	D	A	A	A	A	A	A	B	D	D	A
Hydrocyanic acid	A	A	C	A	A	A	A	A	A	A	—	—	—	B	A
Hydrocyanic acid, gas, 10%	A	A	C	A	A	A	A	—	A	A	—	—	—	—	A
Hydrofluoric acid, 50%	D	A	D	C	D	A	A	D	D	A	—	D	A	D	C

<sup>†</sup>Do not use the L/S\* PTFE-tubing pump head with gases due to excessive heat buildup.



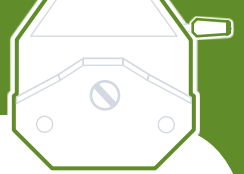

Fluid	Tubing formulation										Pump head material				
	PN	CF	S	T	TU	TC	CD	PFL	V	FP	PSF	PC	PPS	SS	PP
Hydrofluoric acid, 75%	—	A	D	D	D	—	C	D	D	A	—	D	A	D	C
Hydrogen peroxide (dil)	A	A	A	A	A	A	A	A	A	A	A	A	—	B	A
Hydrogen peroxide, 90%	B	D	B	D	D	B	B	A	A	A	A	—	B	A	A
Hypochlorous acid	A	A	D	A	A	A	A	A	A	A	—	—	—	—	—
Iodine solutions	A	C	C	A	A	A	A	—	A	A	—	D	D	D	A
Iodoform	—	—	—	—	—	—	D	—	C	—	—	—	—	A	—
Kerosene	D	D	D	D	B	D	D	A	A	A	A	A	A	A	A
Ketones	D	B	—	D	D	C	C	—	—	A	D	D	A	A	A
Lacquer solvents	B	D	D	D	D	D	D	A	D	A	—	D	—	A	D
Lactic acid, 3–10%	A	A	A	A	A	A	A	A	A	A	A	A	A	B	A
Lead acetate	A	A	D	A	A	A	A	—	D	A	A	—	A	B	A
Linseed oil	C	D	A	D	A	B	B	A	A	A	A	A	A	A	A
Lithium hydroxide	B	A	D	A	A	—	B	—	C	A	—	D	A	B	—
Magnesium chloride	A	A	A	A	A	A	A	A	A	A	A	A	A	B	A
Magnesium sulfate	A	A	A	A	A	A	A	A	A	A	A	A	A	B	A
Malic acid	A	A	B	A	A	A	A	A	A	A	—	—	—	A	B
Manganese salts	A	A	B	A	A	A	A	—	A	A	—	—	—	D	—
Mercury salts	A	A	—	A	A	A	A	—	A	A	—	—	—	B	A
Methane	A	D	D	A	A	A	A	B	A	A <sup>†</sup>	—	—	—	A	B
Methanol (methyl alcohol)	A	—	A	C	C	A	A	A	B	A	D	B	A	A	A
Methyl chloride	C	A	D	D	D	D	D	B	B	A	D	—	A	A	D
Methyl ethyl ketone (MEK)	D	—	D	D	D	C	C	B	D	A	D	D	A	A	A
Mixed acid (40% H <sub>2</sub> SO <sub>4</sub> , 15% HNO <sub>3</sub> )	B	—	—	B	D	—	A	—	—	A	D	—	—	B	A
Molybdenum disulfide	—	A	—	—	—	—	A	—	A	—	—	—	—	—	—
Monoethanolamine	C	B	B	D	D	D	D	—	D	A	A	—	A	A	B
Naphtha	D	D	D	D	B	D	D	B	A	B	B	—	A	A	B
Natural gas	A	D	A	A	A	A	A	B	A	A <sup>†</sup>	—	—	—	A	B
Nickel salts	A	A	A	A	A	A	A	A	A	A	A	—	A	B	A
Nitric acid (dil)	A	A	B	A	D	A	A	A	B	A	A	B	A	A	B
Nitric acid (med)	A	—	C	C	D	A	A	A	A	A	C	C	—	A	B
Nitric acid (conc)	D	—	D	D	D	A	A	A	A	A	C	D	D	A	C
Nitrobenzene	D	D	D	D	D	D	D	A	B	A	D	D	A	B	B
Nitrogen oxides	A	A	D	A	A	A	A	—	D	A	—	—	—	—	—
Nitrous acid	A	A	—	A	C	A	A	—	—	A	—	—	—	B	A
Oils, animal	C	B	B	D	B	B	B	—	A	A	—	—	—	A	—
Oils, mineral	D	B	B	C	A	D	D	—	A	A	B	A	A	A	A
Oils, vegetable	C	B	B	D	A	B	B	A	A	A	A	—	A	A	A
Oleic acid	C	A	D	D	B	D	C	A	B	A	A	A	A	B	A
Oxalic acid, cold	B	A	B	C	D	A	A	A	A	A	—	B	A	B	A
Oxygen, gas	A	A	B	A	A	A	A	A	B	A <sup>†</sup>	A	A	—	A	—
Palmitic acid, 100% in ether	C	—	D	D	B	C	C	A	A	A	—	—	—	B	C
Perchloric acid	A	A	D	C	D	A	A	A	A	A	D	D	A	C	C
Perchloroethylene	C	B	D	D	D	D	D	B	A	A	D	D	A	B	D
Phenol (carbolic acid)	A	D	D	B	C	A	A	A	A	A	—	D	—	B	A
Phosphoric acid, 50%	A	A	C	C	A	A	A	A	A	A	A	B	—	A	A
Phthalic acid	A	D	B	D	A	A	A	—	B	A	—	—	—	B	A
Plating solutions	A	A	D	A	D	A	A	—	A	A	—	—	—	—	A
Polyglycol	B	B	A	A	A	—	B	—	A	—	—	—	—	—	—
Potassium carbonate	A	A	—	A	A	A	A	—	A	—	A	—	A	B	A
Potassium chlorate	B	A	B	B	A	—	A	A	A	A	A	—	A	B	A
Potassium hydroxide (med)	A	A	B	B	D	—	A	B	D	A	A	D	A	B	A
Potassium hydroxide (conc)	A	A	C	D	D	—	A	B	D	A	A	D	—	B	B
Potassium iodide	A	A	—	A	A	A	A	—	A	A	—	—	—	A	B
Propanol (propyl alcohol)	C	—	A	D	A	A	A	A	A	A	B	A	A	A	A
Pyridine	C	A	D	D	D	C	C	A	D	A	D	D	A	A	B
Refrigerant	D	C	—	D	D	A	A	D	—	A	—	D	A	—	—
Silicone fluids	A	B	C	B	A	B	A	—	A	A	—	—	—	A	A
Silicone oils	C	B	C	B	A	B	A	—	A	A	—	—	—	A	A
Silver nitrate	A	A	A	A	A	A	A	A	A	A	A	A	A	B	A
Soap solutions	B	A	A	A	A	A	A	A	A	A	A	A	A	A	A
Sodium bicarbonate	A	A	A	A	A	A	A	A	A	A	A	A	A	B	A
Sodium bisulfate	A	A	—	A	A	A	A	A	A	A	A	A	A	D	A
Sodium bisulfite	A	A	A	A	A	—	A	A	A	A	—	A	—	B	A
Sodium borate	A	A	A	A	A	—	A	—	A	A	A	A	A	B	B
Sodium carbonate	A	A	A	A	A	A	A	A	A	A	A	A	A	A	A
Sodium chlorate	A	A	C	A	A	A	A	—	A	A	A	A	A	B	A
Sodium chloride	A	A	A	A	A	A	A	A	A	A	A	A	A	C	A
Sodium ferrocyanide	A	A	—	B	B	—	A	—	A	A	—	—	—	B	A
Sodium hydrosulfite	B	A	—	A	A	—	A	—	A	A	—	—	—	—	—
Sodium hydroxide (dil)	A	A	A	A	D	A	A	A	A	A	A	D	A	A	A
Sodium hydroxide, 25%	A	B	B	C	D	A	A	—	A	A	A	D	A	B	A
Sodium hydroxide (conc)	—	C	—	C	D	A	A	—	A	A	—	D	A	C	B
Sodium hypochlorite, <5%	A	A	B	A	A	A	A	A	A	A	A	B	A	A	A
Sodium hypochlorite, >5%	A	A	B	A	A	A	A	A	A	A	—	A	C	A	B
Sodium nitrate	A	A	D	A	A	A	A	A	A	A	—	—	A	B	A
Sodium silicate	A	A	A	A	A	—	A	A	A	A	A	—	A	B	A
Sodium sulfide	A	A	A	A	A	A	A	A	A	A	A	—	A	C	A
Sodium sulfite	A	A	A	A	A	A	A	A	A	A	—	D	—	A	B
Steam, up to 40 psi	C	—	A	D	D	—	D	A	B	A <sup>†</sup>	A	A	A	A	—
Stearic acid	C	A	B	A	B	C	C	A	A	A	C	A	—	B	C
Styrene	D	D	D	D	D	D	D	A	A	A	—	D	—	A	—
Sulfuric acid (dil)	A	A	D	A	A	A	A	A	A	A	A	A	A	D	A
Sulfuric acid (med)	A	A	D	A	B	A	A	—	A	A	B	C	A	D	A
Sulfuric acid (conc)	D	A	D	D	D	D	A	C	A	A	D	D	A	C	B
Sulfurous acid	A	A	D	A	A	A	A	—	B	A	A	—	A	B	A
Tannic acid	B	A	B	C	D	A	A	—	A	A	—	—	—	A	B
Tanning liquors	A	B	—	A	A	A	A	—	—	A	—	—	—	A	B
Tartaric acid	A	A	A	A	A	A	A	—	A	A	A	B	A	C	A
Tin salts	A	A	B	A	A	A	A	—	—	A	—	—	—	—	A
Toluene (toluol)	D	D	D	D	D	D	D	A	A	A	D	D	A	A	B
Trichloroacetic acid	B	A	D	A	D	A	A	—	C	A	—	D	A	D	A
Trichloroethylene	D	D	D	D	D	D	D	B	A	A	C	D	A	B	D
Trisodium phosphate	A	A	—	A	A	A	A	—	A	A	—	—	A	B	A
Turpentine	D	D	D	D	B	D	D	A	A	A	—	—	A	A	B
Urea	A	A	B	A	A	A	A	A	—	A	C	D	A	A	A
Uric acid	A	A	—	A	C	A	A	—	—	A	—	—	—	B	—
Water, fresh	A	A	B	A	A	A	A	A	A	A	A	A	A	A	A
Water, salt	A	A	A	A	A	A	A	A	A	A	A	A	A	B	A
Xylene	D	D	D	D	D	D	D	A	A	A	D	D	A	A	C
Zinc chloride	A	A	A	A	A	A	A	A	A	A	A	A	A	D	A

<sup>†</sup> Do not use the L/S® PTFE-tubing pump head with gases due to excessive heat buildup.

## FREE MASTERflex® Tubing Test Kit!

Our FREE Tubing Test Kit is a simple way to test your chemicals against different tubing formulations. Kit contains samples of 19 different pump tubing formulations, formulation descriptions, a selection guide, instructions on how to test your tubing, and complete ordering information. Call today! Request item HL-00101-10.

**Call or go online to request your FREE test kit today!**



## TECHNICAL info!

### Tubing Test Procedure

1. Measure and weigh a sample of tubing.
2. Immerse the sample in the fluid for 72 hours in a closed vessel.
3. Dry sample, then measure and weigh it. Inspect carefully for signs of deterioration such as swelling, embrittlement, cracking, softness, or change of size or weight.
4. If there is no sign of deterioration, test a sample in pump under the conditions of your application.

### Tubing for Food Products

Liquified food products	Norpren® food	Silicone	Tygon® E-Food	FDA Viton®
Alcohol	B	—	—	A
Beer	B	A	—	A
Brandy	B	—	—	A
Butter	A	B	A	A
Carrot	A	—	A	—
Chocolate syrup	A	—	A	—
Citric acid	A	A	A	A
Coffee	A	A	—	A
Corn oil	—	A	—	A
Corn syrup	—	—	A	A
Fish	—	A	A	—
Fruit juices	A	—	A	—
Liqueurs	B	B	—	A
Mayonnaise	A	—	A	A
Milk	A	A	A	A
Milk of magnesia	A	—	B	—
Molasses	A	—	B	A
Orange syrup	A	B	—	A
Sauerkraut	A	—	B	—
Shortening (Liq)	C	B	—	A
Soft drink concentrate	B	C	—	—
Sugar	A	A	A	A
Tomatoes	A	—	A	A
Vegetable oil	B	B	B	A
Vinegar	A	A	A	A
Whiskey	B	A	B	A
Wines	B	A	B	A

## TUBING PUMPS

### TOP REASONS TO CHOOSE A MASTERFLEX® TUBING PUMP

#### 1 SIMPLICITY

Masterflex® pumps are easy to use. In most cases, they can be installed within minutes. With few moving parts, they're easy to maintain.

#### 2 CONTAMINATION-FREE PUMPING

Since peristaltic pumps confine the fluid to the tubing, the pump cannot contaminate the fluid and the fluid cannot contaminate your pump. To pump a different fluid, simply change the tubing.

#### 3 ECONOMY

Feature-for-feature, you will not find a lower priced tubing pump on the market. For economical liquid transfer, you can buy a complete variable-speed Masterflex pump for under \$600.

#### 4 ACCURACY

Each component of a Masterflex tubing pump is designed to strict standards and then rigorously tested; you can be confident of extremely accurate flow delivery.

#### 5 SELECTION

Masterflex drives, coupled with interchangeable pump heads and tubing, offer wide flow ranges and more than 10,000 possible pump combinations. Our pumps are designed for a wide variety of environments, from basic laboratory to industrial process to field use applications.

#### 6 DURABILITY

A Masterflex tubing pump system does not have direct contact with the pumped fluid, so it has a longer service life than other pumps.

#### 7 VERSATILITY

One of the biggest advantages of variable-speed pumping is the wide variety of applications a single pump can handle. Masterflex pumps enhance this advantage by offering many different pump heads for each drive. By interchanging the components, you effectively customize the pump for your changing needs.

#### 8 APPLICATION ASSISTANCE

Contact your Masterflex distributor for expert product and technical assistance on any Masterflex tubing pump system.

#### 9 OEM ADAPTABILITY

Masterflex pumps are ideal for a wide variety of original equipment manufacturing (OEM) applications.

## C/L® TUBING PUMPS

C/L® tubing pumps combine low flow and a compact size into a single pump that sits on your benchtop or panel mounts in your equipment rack—ideal for analyzer applications.

**Pumps/Tubing** ..... 34–37



LOW FLOW



FLOW RANGE  
0.002 to 43 mL/min

OEM

COMPACT

## L/S® TUBING PUMPS

This pump group includes fixed- and variable-speed pumps. It features high-accuracy drives for precise flow control and dispensing. L/S® pumps are designed for laboratory, process, or field use.

**Pump heads** ..... 38–67

**Tubing** ..... 68–73

**Drives** ..... 74–107

**Systems** ..... 108–117



EASY TO USE

FLOW RANGE  
0.0006 to 3400 mL/min

PRECISION

PROCESS



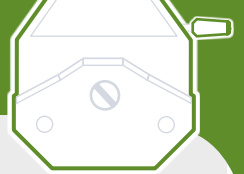

### FROM LAB TO PROCESS

## I/P® TUBING PUMPS

I/P® pumps are characterized by powerful motors and better protection from the hazards of industry like dust and water. Use these pumps in your manufacturing process or for quick fluid transfer in your lab.

**Pump heads** ..... 118–125

**Tubing** ..... 126–130

**Drives** ..... 131–145

**Systems** ..... 146–151



**FLOW RANGE**  
0.001 to 26 LPM

BRUSHLESS

INDUSTRIAL

WASHDOWN

### APPLICATION TIPS FOR MASTERFLEX TUBING PUMPS

#### TO MAXIMIZE TUBING LIFE

- ▶ Run larger tube sizes at slower speeds
- ▶ Select longer-life material (see “Tubing Selection Hints” below)
- ▶ Reduce pressure in system
- ▶ Stop pump periodically, move tubing 20 to 25 cm (8 to 10 inches) forward
- ▶ Reduce occlusion if possible

#### TO PUMP VISCOUS FLUIDS

- ▶ Choose tubing at least one size larger than the flow rate requires
- ▶ Keep drive speed below 300 rpm; the slower the motor, the better the flow
- ▶ Pressurize the inlet
- ▶ Use adjustable occlusion pumps: over-occlude to prime; reduce occlusion for longer life

#### TO PUMP ABRASIVE FLUIDS

- ▶ Keep soft particle sizes <25% of tube ID
- ▶ Keep hard particle sizes <5% of tube ID
- ▶ Keep drive speed below 300 rpm
- ▶ Use adjustable occlusion pumps: over-occlude to prime; reduce occlusion for longer life

#### TO REDUCE PULSATION

- ▶ Use a pulse dampener
- ▶ Use adjustable occlusion pump: reduce occlusion and apply back pressure
- ▶ Use dual (stacked) heads with offset rollers and unify channels
- ▶ Add extra discharge tubing to system
- ▶ Run smaller tube sizes at higher speeds
- ▶ Use a pump head with a higher number of rollers

#### TO CHECK TUBING COMPATIBILITY

- ▶ See the Masterflex Tubing Compatibility Tables on pages 30–31
- ▶ Follow the Tubing Test procedure on page 31
- ▶ Always pretest unfamiliar chemicals before using with desired tubing
- ▶ Call to request a Free Masterflex Tubing Test Kit today!

#### TUBING SELECTION HINTS

- ▶ See Tubing Formulation Descriptions on pages 20–24
- ▶ Longest life: Norprene®, PharMed® BPT, Tygon® E-LFL, GORE® Style 100 and Style 500, Puri-Flex™, Biopharm Plus silicone, PharmaPure®, Chem-Durance® Bio
- ▶ Best clarity: Tygon® formulations, silicone (platinum-cured)
- ▶ USP Class VI: Silicones, C-FLEX®, C-Flex® ULTRA, PharMed® BPT, PharmaPure®, Puri-Flex™, Chem-Durance® Bio, Tygon® Chemical, Tygon® E-LFL, PTFE
- ▶ High purity: PTFE, GORE® Style 500, PharmaPure®
- ▶ Pressure/vacuum: Norprene®, Norprene® HP, PharMed® BPT, PharMed® BPT HP, PharmaPure®

## B/T® TUBING PUMPS

B/T® pumps have the highest flow rates of any pumps in our Masterflex line. They are ideal for transferring large batches of fluids. B/T tubing pumps have heavy-duty motors and excellent hazard protection.

**Pumps** ..... 152–158

**Pump heads** ..... 159

**Tubing** ..... 153

HEAVY-DUTY



**FLOW RANGE**  
0.3 to 42 LPM

MANUFACTURING

HIGH FLOW

## CL<sup>®</sup> VARIABLE-SPEED SINGLE-CHANNEL TUBING PUMPS

### FEATURES/BENEFITS

- ▶ Deliver flow rates from 0.002 to 43.0 mL/min
- ▶ Ideal for chromatography, spectroscopy, analyzer, and dispensing applications
- ▶ Compact ¼-DIN housing
- ▶ Mount on equipment rack or place on lab bench
- ▶ Reversible motor for pumping fluid in either direction
- ▶ Remote control capabilities
- ▶ Change tubing quickly by releasing built-in retainers
- ▶ Use all sizes of microbore tubing
- ▶ Average fixed occlusion eliminates adjustment after tubing change
- ▶ Suitable for OEM applications

### DRIVE CONTROLS

- ▶ All manual controls on front panel
- ▶ Separate 1-turn speed control and CW/OFF/CCW switch with green LED power indicator
- ▶ Maintain speed setting when pump is turned on/off or reversed
- ▶ "Max" button runs pump at 100% of max rpm to prime or rapidly flush tubing



C/L variable-speed single-channel pump 77122-24

**NEW**



ISO9001:2008  
CERTIFIED SUPPLIER

CE 1 year warranty

Power supplies are:



### SETUP

1. Open cover to lower occlusion bed.
2. Wrap tubing around rollers.
3. Secure tubing in retainers.
4. Snap occlusion bed shut and close cover.
  - ◆ Pump head has average fixed occlusion, so there's no need for adjustment
  - ◆ 1.5 m (5 ft) of 0.89-mm ID Tygon® E-LFL tubing supplied

See specifications on next page for more information.

### SPEED CONTROL/CIRCUITRY

- ▶ CW/OFF/CCW switch and 1-turn potentiometer
- ▶ Speed control: ±5%
- ▶ Current limited: 1.0 A DC max
- ▶ Voltage: 100 to 240 VAC (50/60 Hz) or 12 VDC
- ▶ Humidity: 10 to 90%

### REMOTE CONTROL

- ▶ Remote control connections on back of dual-channel and single-channel pumps
- ▶ Start/stop pump with contact closure

### ORDERING INFORMATION

Catalog number	rpm	Power (50/60 Hz)
<a href="#">HL-77122-04</a>	1.7 to 10	90 to 260 VAC
<a href="#">HL-77122-06</a>		12 VDC†
<a href="#">HL-77122-14</a>	13 to 80	90 to 260 VAC
<a href="#">HL-77122-16</a>		12 VDC†
<a href="#">HL-77122-24</a>	50 to 300	90 to 260 VAC
<a href="#">HL-77122-26</a>		12 VDC†

†Power supply not included with 12 VDC models.

### MICROBORE PUMP TUBING FLOW RATE INFORMATION (mL/MIN)

rpm	Microbore pump tubing size (ID)							
	0.19 mm	0.25 mm	0.51 mm	0.89 mm	1.14 mm	1.42 mm	2.06 mm	2.79 mm
1.7 to 10	0.002 to 0.013	0.004 to 0.022	0.015 to 0.087	0.041 to 0.25	0.064 to 0.39	0.09 to 0.57	0.18 to 1.05	0.28 to 1.65
13 to 80	0.017 to 0.10	0.03 to 0.18	0.12 to 0.70	0.33 to 2.0	0.52 to 3.1	0.75 to 4.5	1.4 to 8.5	1.8 to 11.0
50 to 300	0.06 to 0.38	0.11 to 0.67	0.43 to 2.6	1.2 to 7.4	1.9 to 11.5	2.8 to 17.0	5.3 to 32	7.2 to 43

### MICROBORE PUMP TUBING ORDERING INFORMATION

Tube ID (mm)	Tygon® E-Lab	Silicone, platinum-cured	Silicone, peroxide-cured	PharMed® BPT	Tygon E-LFL (long flex life)	Viton®	Puri-Flex™	C-FLEX®	Solvent/hydrocarbon
0.19	<a href="#">HL-06460-10</a>	—	—	—	—	—	<a href="#">HL-96418-10</a>	<a href="#">HL-95718-10</a>	<a href="#">HL-95712-10</a>
0.25	<a href="#">HL-06460-12</a>	—	—	<a href="#">HL-95809-12</a>	—	—	<a href="#">HL-96418-12</a>	<a href="#">HL-95718-12</a>	<a href="#">HL-95712-12</a>
0.51	<a href="#">HL-06460-18</a>	<a href="#">HL-95590-18</a>	—	<a href="#">HL-95809-18</a>	<a href="#">HL-06449-18</a>	—	<a href="#">HL-96418-18</a>	<a href="#">HL-95718-18</a>	<a href="#">HL-95712-18</a>
0.89	<a href="#">HL-06460-26</a>	<a href="#">HL-95590-26</a>	<a href="#">HL-07625-26</a>	<a href="#">HL-95809-26</a>	<a href="#">HL-06449-26</a>	<a href="#">HL-97632-26</a>	<a href="#">HL-96418-26</a>	<a href="#">HL-95718-26</a>	<a href="#">HL-95712-26</a>
1.14	<a href="#">HL-06460-30</a>	<a href="#">HL-95590-30</a>	<a href="#">HL-07625-30</a>	<a href="#">HL-95809-30</a>	<a href="#">HL-06449-30</a>	<a href="#">HL-97632-30</a>	<a href="#">HL-96418-30</a>	<a href="#">HL-95718-30</a>	<a href="#">HL-95712-30</a>
1.42	<a href="#">HL-06460-34</a>	<a href="#">HL-95590-34</a>	<a href="#">HL-07625-34</a>	<a href="#">HL-95809-34</a>	<a href="#">HL-06449-34</a>	<a href="#">HL-97632-34</a>	<a href="#">HL-96418-34</a>	<a href="#">HL-95718-34</a>	<a href="#">HL-95712-34</a>
2.06	<a href="#">HL-06460-42</a>	<a href="#">HL-95590-42</a>	<a href="#">HL-07625-42</a>	<a href="#">HL-95809-42</a>	<a href="#">HL-06449-42</a>	<a href="#">HL-97632-42</a>	<a href="#">HL-96418-42</a>	<a href="#">HL-95718-42</a>	<a href="#">HL-95712-42</a>
2.79	<a href="#">HL-06460-48</a>	<a href="#">HL-95590-48</a>	<a href="#">HL-07625-48</a>	<a href="#">HL-95809-48</a>	<a href="#">HL-06449-48</a>	<a href="#">HL-97632-48</a>	<a href="#">HL-96418-48</a>	<a href="#">HL-95718-48</a>	<a href="#">HL-95712-48</a>
Quantity/pack	30.4 m (100 ft)	15.2 m (50 ft)	15.2 m (50 ft)	30.4 m (100 ft)	30.4 m (100 ft)	15.2 m (50 ft)	15.2 m (50 ft)	15.2 m (50 ft)	15.2 m (50 ft)



## SPECIFICATIONS for C/L Variable-Speed Single-Channel Tubing Pumps

Catalog number	<a href="#">HL-77122-04</a>	<a href="#">HL-77122-06</a>	<a href="#">HL-77122-14</a>	<a href="#">HL-77122-16</a>	<a href="#">HL-77122-24</a>	<a href="#">HL-77122-26</a>
<b>Performance specifications</b>						
Flow capacity	0.002 to 1.65 mL/min		0.017 to 11.0 mL/min		0.06 to 43 mL/min	
rpm	1.7 to 10		13 to 80		50 to 300	
Number of channels	1					
Max torque	3.6 kg-cm (50 oz-in)					
Reversible	Yes					
External control - input	Start/stop with contact closure					
<b>Electrical specifications</b>						
Voltage VAC (50/60 Hz)	90 to 260 VAC	12 VDC	90 to 260 VAC	12 VDC	90 to 260 VAC	12 VDC
Current (mA)	110 at 115 V	—	175 at 115 V	—	400 at 115 V	—
Fuse rating	Not applicable					
Motor type	Permanent-magnet DC					
Motor size	0.24 W (<1/25 hp subtract)	2.0 W (<1/25 hp subtract)		7.3 W (<1/25 hp subtract)		
Display	LED power indicator light					
Motor/speed control type	1-turn potentiometer					
Speed regulation (repeatability)	±5% (±5%)					
Soft start/electronic brake	Yes / No					
<b>Physical specifications</b>						
Housing materials	¼ DIN ABS plastic					
Pump head materials	Polyphenylene sulfide (PPS), acetal, and copolyester with stainless steel rollers					
IP rating†	IP22					
Agency listings	CE; power supplies: CSA, UL, GS					
Operating temperature	0 to 40°C (32 to 104°F)					
Storage temperature	-45 to 65°C (-49 to 149°F)					
Noise level	<70 dBA @ 1 m (39")					
Dimensions (L x W x H)	17.8 x 8.9 x 8.9 (7.0 x 3.5 x 3.5)					
Shipping weight	1.4 kg (3.0 lb)					

†See page 194 for an explanation of IP ratings.

## ACCESSORIES

- [HL-77120-03](#) Brackets for panel mounting. Set of 2.
- [HL-77120-11](#) Replacement power supply for 77122-04, -14, -24
- [HL-17050-01](#) NIST-traceable calibration for peristaltic pump drive



## HOW TO LOAD YOUR PUMP HEAD



1. Open the cover and release the occlusion bed.



2. Insert tubing in right or left retainer and wrap tubing around the rollers. Secure tubing in opposite retainer.



3. Close cover.

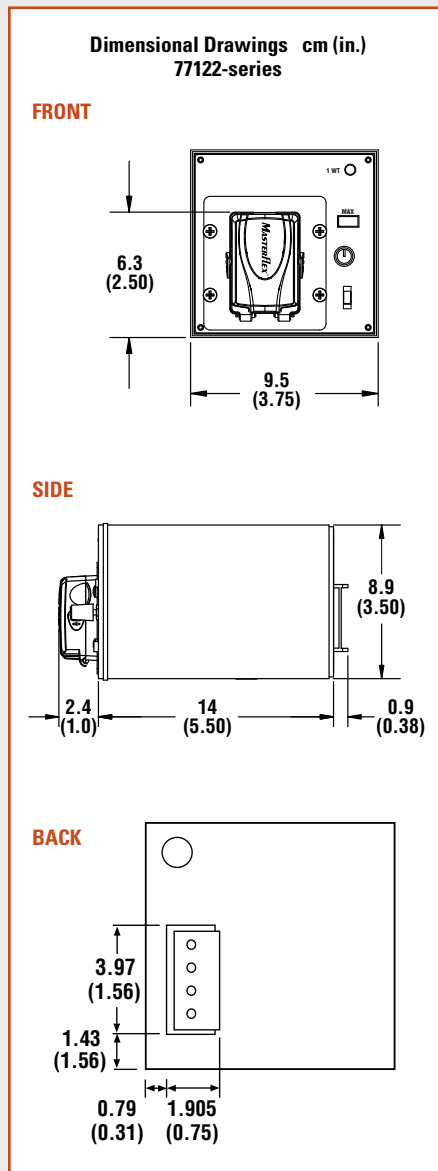

## FOR THE LATEST...

Masterflex technical resources, see

- ColeParmer.com
- Masterflex.com

ACCESSORIES ..... 160-171

TECHNICAL DATA..... 172-206

## CL<sup>®</sup> VARIABLE-SPEED DUAL-CHANNEL TUBING PUMPS

### FEATURES/BENEFITS

- ▶ Deliver flow rates from 0.002 to 37.0 mL/min
- ▶ Ideal for chromatography, spectroscopy, analyzer, and dispensing applications
- ▶ Compact ¼-DIN housing
- ▶ Mount on equipment rack or place on lab bench
- ▶ Reversible motor for pumping fluid in either direction
- ▶ Remote control capabilities
- ▶ Change tubing quickly by releasing built-in retainers
- ▶ Use all sizes of microbore tubing
- ▶ Average fixed occlusion eliminates adjustment after tubing change
- ▶ Suitable for OEM applications

### DRIVE CONTROLS

- ▶ All manual controls on front panel
- ▶ Separate 1-turn speed control and CW/OFF/CCW switch with green LED power indicator
- ▶ Maintain speed setting when pump is turned on/off or reversed
- ▶ "Max" button runs pump at 150% of max rpm to prime or rapidly flush tubing



C/L variable-speed dual-channel pump 77120-32



The ideal pump for analyzer feed applications

### SETUP

1. Lower occlusion bed.
2. Wrap tubing around rollers.
3. Secure tubing in retainer.
4. Snap occlusion bed shut.
  - ◆ Pump head has average fixed occlusion, so there's no need for adjustment
  - ◆ 1.5 m (5 ft) of 0.89-mm ID Tygon® E-LFL tubing supplied

See specifications on next page for more information.

### SPEED CONTROL/CIRCUITRY

- ▶ CW/OFF/CCW switch and 1-turn potentiometer
- ▶ Speed control: ±5%
- ▶ Current limited: 1.0 A DC max
- ▶ Voltage: 90 to 260 VAC (50/60 Hz) or 12 VDC
- ▶ Humidity: 10 to 90%

### REMOTE CONTROL

- ▶ Remote control connections on back of pumps
- ▶ Start/stop pump with contact closure

ISO9001:2008  
CERTIFIED SUPPLIER



1 year  
warranty

Power supplies are:



### ORDERING INFORMATION

Catalog number	rpm	Power (50/60 Hz)
HL-77120-32	1 to 6	90 to 260 VAC
HL-77120-52 <sup>†</sup>		12 VDC
HL-77120-42	10 to 60	90 to 260 VAC
HL-77120-62 <sup>†</sup>		12 VDC

<sup>†</sup>Power supply not included with 12 VDC models.

### MICROBORE PUMP TUBING FLOW RATE INFORMATION (mL/MIN)

rpm	Microbore pump tubing size (ID)							
	0.19 mm	0.25 mm	0.51 mm	0.89 mm	1.14 mm	1.42 mm	2.06 mm	2.79 mm
1 to 6	0.002 to 0.013	0.0028 to 0.017	0.012 to 0.07	0.036 to 0.20	0.057 to 0.34	0.08 to 0.49	0.15 to 0.88	0.22 to 1.3
10 to 60	0.02 to 0.13	0.03 to 0.18	0.12 to 0.7	0.36 to 2.13	0.55 to 3.3	0.8 to 4.9	1.5 to 8.9	2.1 to 12.3

### MICROBORE PUMP TUBING ORDERING INFORMATION

Tube ID (mm)	Tygon® E-Lab	Silicone, platinum-cured	Silicone, peroxide-cured	PharMed® BPT	Tygon E-LFL (long flex life)	Viton®	Puri-Flex™	C-FLEX®	Solvent/hydrocarbon
0.19	HL-06460-10	—	—	—	—	—	HL-96418-10	HL-95718-10	HL-95712-10
0.25	HL-06460-12	—	—	HL-95809-12	—	—	HL-96418-12	HL-95718-12	HL-95712-12
0.51	HL-06460-18	HL-95590-18	—	HL-95809-18	HL-06449-18	—	HL-96418-18	HL-95718-18	HL-95712-18
0.89	HL-06460-26	HL-95590-26	HL-07625-26	HL-95809-26	HL-06449-26	HL-97632-26	HL-96418-26	HL-95718-26	HL-95712-26
1.14	HL-06460-30	HL-95590-30	HL-07625-30	HL-95809-30	HL-06449-30	HL-97632-30	HL-96418-30	HL-95718-30	HL-95712-30
1.42	HL-06460-34	HL-95590-34	HL-07625-34	HL-95809-34	HL-06449-34	HL-97632-34	HL-96418-34	HL-95718-34	HL-95712-34
2.06	HL-06460-42	HL-95590-42	HL-07625-42	HL-95809-42	HL-06449-42	HL-97632-42	HL-96418-42	HL-95718-42	HL-95712-42
2.79	HL-06460-48	HL-95590-48	HL-07625-48	HL-95809-48	HL-06449-48	HL-97632-48	HL-96418-48	HL-95718-48	HL-95712-48
Quantity/pack	30.4 m (100 ft)	15.2 m (50 ft)	15.2 m (50 ft)	30.4 m (100 ft)	30.4 m (100 ft)	15.2 m (50 ft)	15.2 m (50 ft)	15.2 m (50 ft)	15.2 m (50 ft)



## SPECIFICATIONS for C/L Variable-Speed Dual-Channel Tubing Pumps

Catalog number	<a href="#">HL-77120-32</a>	<a href="#">HL-77120-52</a>	<a href="#">HL-77120-42</a>	<a href="#">HL-77120-62</a>
<b>Performance Specifications</b>				
Flow capacity	0.002 to 1.3 mL/min		0.02 to 12.3 mL/min	
rpm	1 to 6		10 to 60	
Number of channels	2			
Max torque	3.6 kg-cm (50 oz.-in)			
Reversible	Yes			
External control – input	Start/stop with contact closure			
<b>Electrical Specifications</b>				
Voltage (50/60 Hz)	90 to 260 VAC	12 VDC	90 to 260 VAC	12 VDC
Current (mA)	150 at 115 V	—	150 at 115 V	—
Fuse rating	Not applicable			
Motor type	Permanent-magnet DC			
Motor size	5 W (<1/25 hp subtract)		12 W (<1/25 hp subtract)	
Display	LED power indicator light			
Motor/speed control type	1-turn potentiometer			
Speed regulation (repeatability)	±5% (±5%)			
Soft-start/electronic brake	Yes / No			
<b>Physical Specifications</b>				
Housing materials	¼-DIN ABS plastic			
Pump head materials	Polyphenylene sulfide (PPS), stainless steel (SS), and six acetal polymer rollers			
IP rating†	IP22			
Agency listings	CE; Power supplies: CSA, UL, GS			
Operating temperature	0 to 40°C (32 to 104°F)			
Storage temperature	-45 to 65°C (-13 to 149°F)			
Noise level	<70 dBA @ 1 m (39")			
Dimensions (L x W x H)	19 x 9.5 x 8.9 cm (7½" x 3¾" x 3½")			
Shipping weight	1.4 kg (3.0 lb)			

†See page 194 for an explanation of IP ratings.

## ACCESSORIES

[HL-77120-03](#) Brackets for panel mounting. Set of 2.

[HL-77120-11](#) Replacement power supply for 77120-32 and -42.

[HL-17050-01](#) NIST-traceable calibration for peristaltic pump drive



Brackets  
77120-03

## HOW TO LOAD YOUR PUMP HEAD



1. Lower occlusion bed. Wrap tubing around rollers and secure tubing retainers.



2. Snap occlusion bed shut.

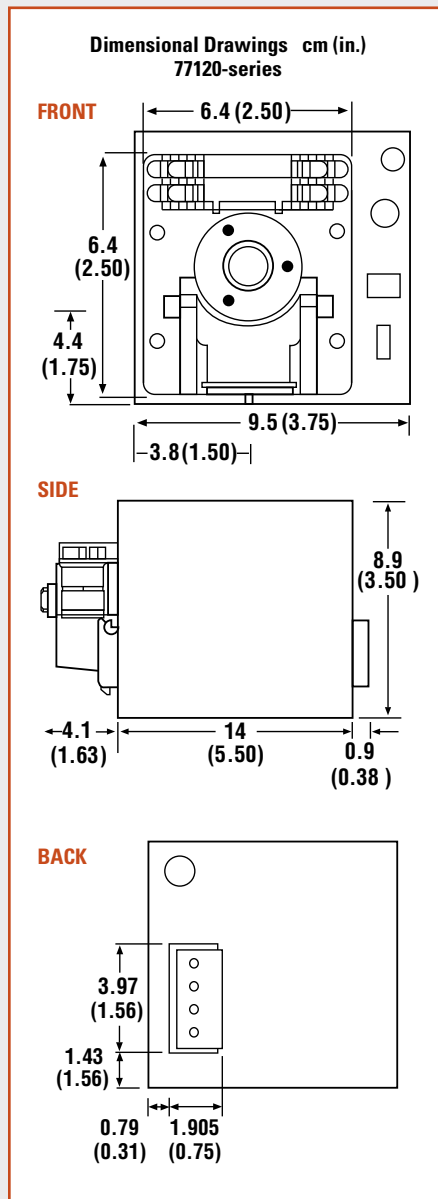

## FOR THE LATEST...

Masterflex technical resources, see

- ColeParmer.com
- Masterflex.com

ACCESSORIES..... 160–171

TECHNICAL DATA..... 172–206

## SELECTION GUIDE FOR L/S PUMP HEADS

### FEATURES OF MASTERFLEX® L/S PUMP HEADS

#### High Accuracy, Repeatable Performance

- Deliver flow rates from 0.00001 to 3400 mL/min
- Pump heads are designed to work best with Masterflex L/S precision pump tubing, ensuring confidence in pump performance
- Most pump designs accept continuous lengths of tubing, allowing you to:
  - Customize tubing lengths to your application
  - Simplify sanitary setups—no breaks in tubing
  - Reduce setup/cleanup time
  - Eliminate difficult fittings and clamps
  - Increase tubing life—periodically stop the pump, move tubing 15 to 20 cm (6 to 8 in.), reload, and continue pumping

#### Multiple Roller Design

- Ensures even flow with minimal pulsation
- Ball-bearing rollers for long service life
- Select from cold-rolled steel (CRS) or stainless steel (SS) rotor assemblies

#### Rugged Plastic Housings

- Molded from engineered plastics to tight specifications
- Lightweight, easy to handle
- Clear polycarbonate (PC) allows for viewing of pump head operation
- Polysulfone (PSF), polyphenylene sulfide (PPS), and polypropylene (PP) offer additional corrosion resistance

#### Three Occlusion Options











- Standard Fixed Occlusion:**  
Tubing “squeeze” is fixed, but at slightly different levels for each tube size to maximize performance in each pump head with respect to tubing life, vacuum and flow characteristics and repeatability. (e.g. Standard pump heads.)
- Average Fixed Occlusion:**  
Tubing “squeeze” is fixed at an average level for either precision or high-performance precision tube sizes. This allows pump heads to combine easy tubing loading while accepting a wide range of tubing sizes. (e.g. Easy-Load® series)
- Adjustable Occlusion:**  
“Squeeze” is adjustable for optimal pump performance to fit a specific application. (e.g. Easy-Load® II and cartridge heads)

#### Adjustable Occlusion

Reducing the occlusion increases tubing life (up to five times); reduces discharge pressure; decreases pulsation; reduces cell disruption; and increases flow slightly.

Increasing the occlusion decreases tubing life; increases discharge pressure; increases pulsation and decreases flow slightly.

One common technique for prolonging tubing life is to prime the pump with nominal or high occlusion, and then reduce the occlusion slightly.

Type	Flow rates mL/min	Number of rollers	Multichannel or stackable	Housing/roller materials†	Special features	Page number
<b>STANDARD</b>						
	Lowest: 0.001 Highest: 2900	3	Yes, stack up to 4 heads	PC/CRS, PC/SS, or PPS/SS	Low cost, high precision and accuracy. Best choice for dispensing applications. One head accepts one tubing size.	40–41
<b>EASY-LOAD® 3</b>						
	Lowest: 0.001 Highest: 2900	3	Yes, stack up to 4 heads	PP and nylon/CRS or SS	Easiest tubing changes with automatic retention, same side tubing entry/exit. Mount and stack heads without tools or hardware.	42–43
<b>EASY-LOAD® II</b>						
	Lowest: 0.001 Highest: 2900	4	Yes, stack up to 4 heads	PPS/CRS or PPS/SS	Same as Easy-Load (below) but with automatic tubing retention, and higher flow rates. Models with adjustable occlusion.	44–45
<b>EASY-LOAD®</b>						
	Lowest: 0.001 Highest: 2300	3	Yes, stack up to 4 heads	PSF/CRS, PSF/SS, or PPS/SS	Very fast tubing changes. One head accepts many tubing sizes. Change tubing without dismounting pump head from drive.	46–47
<b>HIGH-PERFORMANCE</b>						
	Lowest: 0.006 Highest: 3400	3	No	Polyester, SS, PPS/SS	Accepts all high-performance precision tubing sizes. Offers highest flow rate of any L/S pump head. Tubing enters and exits same side of pump head.	48–49
<b>PTFE-TUBING</b>						
	Lowest: 0.001 Highest: 65	6	No	Aluminum, acetal/SS	Technology breakthrough! Rigid PTFE tubing is the only wetted part. Pressure capability to 6.9 bar (100 psi).	50–51
<b>MULTICHANNEL</b>						
	Lowest: 0.00005 Highest: 2300 (per channel)	3 or 6	Yes, stack for up to 32 channels	Aluminum/SS	Synchronous flow from up to 32 channels without cartridges. Two-stop tubing sets are easy to load with no adjustment needed.	52–55
<b>MULTICHANNEL CARTRIDGE</b>						
	Lowest: 0.00001 Highest: 1700 (per channel)	3, 4, 6, or 8	Yes, 1 to 12 channels	PSF/SS or PSF/Rulon®	Synchronous flow rates from each channel. Cartridges snap in and out quickly for multichannel applications. More rollers reduce pulsation in the output flow.	56–59
<b>PTFE-DIAPHRAGM</b>						
	Lowest: 10 Highest: 800	—	No	—	PTFE and borosilicate glass are the only wetted parts. Excellent for metering. Pressure capability to 6.9 bar (100 psi).	60–61
<b>MASTERFLEX® PARTNERS</b>						
	See pages 62-67 for exact specifications.				Choose from 3 different pump heads. Each style mounts directly onto a Masterflex drive.	62–67

†PC = polycarbonate PP = polypropylene PPS = polyphenylene sulfide PSF = polysulfone CRS = cold-rolled steel SS = stainless steel

### PUMP TUBING OPTIONS FOR L/S PUMP HEADS

L/S pump head	Microbore pump tubing	L/S Precision pump tubing sizes						L/S High-performance Precision pump tubing sizes			
		L/S 13	L/S 14	L/S 16	L/S 25	L/S 17	L/S 18	L/S 15	L/S 24	L/S 35	L/S 36
Standard		✓	✓	✓		✓	✓	✓	✓	✓	✓
Easy-Load 3 and II		✓	✓	✓	✓	✓	✓	✓	✓	✓	✓
Easy-Load		✓	✓	✓	✓	✓	✓	✓	✓		
High-Performance								✓	✓	✓	✓
Multichannel	✓	✓	✓	✓				✓	✓	✓	
Multichannel cartridge	✓	✓	✓	✓	✓	✓					





## A PUMP HEAD FOR EVERY APPLICATION

There are nine styles of Masterflex L/S pump heads offered to meet your specific pumping needs. This selection guide is designed to help you choose the pump head that's right for your application.

### STANDARD PUMP HEAD (pages 40–41)

- ▶ Best overall pump head performance
- ▶ Each pump head designed for one tube size
- ▶ Fixed occlusion set optimally for tube size
- ▶ Stack up to 4 heads



### EASY-LOAD<sup>®</sup> 3 PUMP HEAD (pages 42–43)

- ▶ Automatic tubing retention speeds tube loading and fluid changeover
- ▶ Same side tubing entry/exit for easy integration into space-limited applications
- ▶ Twist-lock mounting feature lets you mount and stack heads in seconds without tools or hardware
- ▶ Stack up to 4 heads



### EASY-LOAD<sup>®</sup> II PUMP HEAD (pages 44–45)

- ▶ Load tubing easily without removing pump head(s) from drive
- ▶ Accepts several tubing sizes for a wide flow range
- ▶ Fixed and adjustable occlusion models available
- ▶ Automatic tubing retention system
- ▶ Stack up to 4 heads



### EASY-LOAD<sup>®</sup> PUMP HEAD (pages 46–47)

- ▶ Load tubing easily without removing pump head(s) from drive
- ▶ Accepts several tubing sizes for a wide flow range
- ▶ Fixed occlusion averaged for several tubing sizes
- ▶ Stack up to 4 heads
- ▶ ATEX Zone 2 rated models available



### HIGH-PERFORMANCE PUMP HEAD (pages 48–49)

- ▶ Load tubing easily and in a "C" pattern
- ▶ Accepts only high-performance precision tubing
- ▶ Fixed occlusion averaged for several tubing sizes
- ▶ Pressures up to 150 psi with L/S HP tubing
- ▶ Not stackable
- ▶ ATEX Zone 2 rated models available



## TO SELECT A PUMP HEAD, DETERMINE:

1. Flow rate (mL/min).
2. Maximum number of pump heads or flow channels required.
3. Fixed or adjustable occlusion feature.
4. Are corrosive fluids or vapors involved? If so, choose corrosion-resistant PSF, PP, or PPS housing and SS rotor, or a PTFE-tubing pump.

### PTFE-TUBING PUMP HEAD (pages 50–51)

- ▶ PTFE is the only wetted part, allowing you to transfer aggressive organic solvents
- ▶ Adjustable occlusion for higher pressure or longer tubing life
- ▶ Use with rigid tubing for pressures up to 100 psi
- ▶ Pump head uses 4- or 6-mm OD rigid PTFE-tubing sets
- ▶ Not stackable



### MULTICHANNEL PUMP HEAD (pages 52–55)

- ▶ Two-, four, and eight-channel heads are stackable for up to 32 synchronous flow channels
- ▶ Models available for microbore or L/S two-stop tube sets
- ▶ Two-stop tube sets are easy to load and self retaining with no adjustment
- ▶ Durable stainless steel and anodized aluminum construction



### MULTICHANNEL CARTRIDGE PUMP HEAD (pages 56–59)

- ▶ Tubing cartridges let you load tubing in a snap without removing pump head from drive
- ▶ Cartridges accept several tubing sizes for a wide flow range
- ▶ Adjustable occlusion for higher pressure or longer tubing life
- ▶ Load up to 12 small or 6 large cartridges in one head



### PTFE-DIAPHRAGM PUMP HEAD (pages 60–61)

- ▶ Designed for demanding chemical compatibility and high-purity applications
- ▶ Maintain  $\pm 2\%$  repeatability across varying system pressures and fluid viscosities
- ▶ Maintain a consistent flow performance up to 75 or 100 psi, depending on pump head



## DRIVE COMPATIBILITY

Mount on all drives accepting Masterflex L/S pump heads. Look for these pump head icons on the specific drive pages to ensure compatibility.

EASY-LOAD<sup>®</sup>  
pages 46–47



HIGH-PERFORMANCE  
pages 48–49



PTFE-TUBING  
pages 50–51



MULTICHANNEL  
pages 52–55



MULTICHANNEL  
CARTRIDGE  
pages 56–59



PTFE-DIAPHRAGM  
pages 60–61



STANDARD  
pages 40–41



EASY-LOAD<sup>®</sup> 3  
pages 42–43



EASY-LOAD<sup>®</sup> II  
pages 44–45



## L/S® STANDARD PUMP HEADS

### FEATURES/BENEFITS

- ▶ Ideal for fluid transfer applications where accuracy and repeatability are important
- ▶ Tubing enters/exits on top of pump head
- ▶ Deliver flow rates from 0.06 to 2900 mL/min
- ▶ Precision molded housing and tubing cavity
- ▶ Each pump head is designed for one size of tubing—ensuring optimal occlusion and performance
- ▶ Adapts easily to OEM applications
- ▶ Interchangeable
- ▶ Stackable for multichannel pumping

### SELECTION CRITERIA

1. Flow rate/tube size desired.
2. Materials of construction.
3. Compatibility with drives.

See specifications for more information.

**Order tubing and drives separately.**

### COMPATIBILITY WITH DRIVES

- ▶ Mount on all drives accepting Masterflex L/S pump heads

### PUMP HOUSING SPECIFICATIONS

#### Clear Polycarbonate (PC)

- ▶ General-purpose applications
- ▶ Pump head operation visible through housing
- ▶ Select from CRS/Buna N or 300-series SS/PTFE shielded ball-bearing

#### Polyphenylene Sulfide (PPS)

- ▶ Best protection from corrosive liquids/vapors
- ▶ 300-series stainless steel shielded ball-bearing

### Watch the VIDEO!

Watch video tutorial on how to load Masterflex® L/S® Standard Pump Heads. Go to...

[Masterflex.com/video](http://Masterflex.com/video)



Standard pump head 07015-20

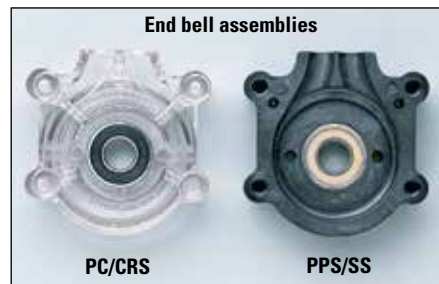

End bell assemblies

PC/CRS

PPS/SS

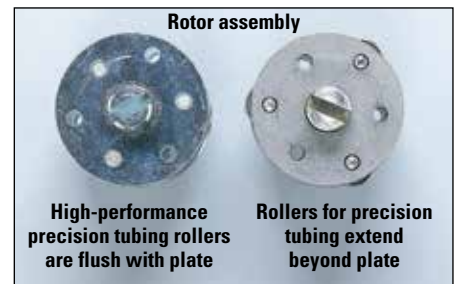

Rotor assembly

High-performance precision tubing rollers are flush with plate

Rollers for precision tubing extend beyond plate

### ROLLER/ROTOR SPECIFICATIONS

#### Plated Cold-Rolled Steel (CRS)

- ▶ General-purpose applications
- ▶ Ball-bearing construction
- ▶ Continuous duty up to 600 rpm

#### 300-Series Stainless Steel (SS)

- ▶ Corrosive fluids
- ▶ Shielded ball-bearing construction (highest life expectancy)
- ▶ Continuous duty up to 600 rpm

ISO9001:2008  
CERTIFIED SUPPLIER

2 year  
warranty

### ORDERING INFORMATION

Pump tubing size	PC housing		PPS housing
	CRS rotor	SS rotor	SS rotor
<b>For Precision tubing</b>			
L/S 13	<a href="#">HL-07013-20</a>	<a href="#">HL-07013-21</a>	<a href="#">HL-07013-52</a>
L/S 14	<a href="#">HL-07014-20</a>	<a href="#">HL-07014-21</a>	<a href="#">HL-07014-52</a>
L/S 16	<a href="#">HL-07016-20</a>	<a href="#">HL-07016-21</a>	<a href="#">HL-07016-52</a>
L/S 17	<a href="#">HL-07017-20</a>	<a href="#">HL-07017-21</a>	<a href="#">HL-07017-52</a>
L/S 18	<a href="#">HL-07018-20</a>	<a href="#">HL-07018-21</a>	<a href="#">HL-07018-52</a>
<b>For High-performance Precision tubing</b>			
L/S 15	<a href="#">HL-07015-20</a>	<a href="#">HL-07015-21</a>	<a href="#">HL-07015-52</a>
L/S 24	<a href="#">HL-07024-20</a>	<a href="#">HL-07024-21</a>	<a href="#">HL-07024-52</a>
L/S 35	<a href="#">HL-07035-20</a>	<a href="#">HL-07035-21</a>	—
L/S 36	<a href="#">HL-07036-30</a>	<a href="#">HL-07036-31</a>	—

PC = polycarbonate PPS = polyphenylene sulfide  
CRS = cold-rolled steel SS = stainless steel

### L/S PUMP TUBING FLOW RATE INFORMATION

Order Masterflex L/S pump tubing separately on pages 68–73

Tubing cross sections	L/S Precision pump tubing					L/S High-performance Precision pump tubing			
	L/S 13	L/S 14	L/S 16	L/S 17	L/S 18	L/S 15	L/S 24	L/S 35	L/S 36
Flow rate—mL/rev	0.06	0.21	0.8	2.8	3.8	1.7	2.8	3.8	4.8
mL/min @ 600 rpm	36	130	480	1700	2300	1000	1700	2300	2900
Max pressure <sup>†</sup>	2.7 bar (40 psi)			1.4 bar (20 psi)	1.0 bar (15 psi)	2.7 bar (40 psi)		2.4 bar (35 psi)	1.4 bar (20 psi)
Max vacuum <sup>†</sup>	660 mm Hg (26" Hg)			510 mm Hg (20" Hg)			660 mm Hg (26" Hg)		
Suction lift	8.8 m H <sub>2</sub> O (29 ft H <sub>2</sub> O)			6.7 m H <sub>2</sub> O (22 ft H <sub>2</sub> O)			8.8 m H <sub>2</sub> O (29 ft H <sub>2</sub> O)		

<sup>†</sup>Actual performance varies depending upon tubing materials—see pages 20–24 and 172–192 for more information.



## SPECIFICATIONS for L/S Standard Pump Heads

Catalog number	HL-070XX-20 and -30 Series	HL-070XX-21 and -31 Series	HL-070XX-52 Series
<b>Performance Specifications</b>			
Flow capacity	0.001 to 2900 mL/min (0 to 46 GPH) <sup>†</sup>		
Max rpm	600		
Number of rollers	3		
<b>Torque Specifications<sup>‡</sup> [a single head pumping water at 0 psi, 21°C (70°F)]</b>			
Norprene®, PharMed® BPT	Starting torque	18.0 kg-cm (250 oz-in)	
	Running torque	5.8 kg-cm (80 oz-in)	
Tygon®, Viton®	Starting torque	27.7 kg-cm (385 oz-in)	
	Running torque	4.6 kg-cm (64 oz-in)	
C-FLEX®, Silicone	Starting torque	5.8 kg-cm (80 oz-in)	
	Running torque	2.2 kg-cm (30 oz-in)	
<b>Physical Specifications</b>			
Housing material	Clear polycarbonate		Polyphenylene sulfide
Rotor material	Cold-rolled steel	Stainless steel	
Operating temperature	0 to 40°C (32 to 104°F)		
Shipping weight	0.54 kg (1.18 lb)		

<sup>†</sup>Depending on pump head selected.

<sup>‡</sup>Actual torque depends on tubing size formulation. For complete torque data, please see pages 172–192.

## MULTICHANNEL CAPABILITIES

Mount up to four pump heads depending on the drive. Order hardware based on the number of pump heads to be mounted.



Mounting hardware

## MOUNTING HARDWARE

Heads to be mounted	Catalog number/set
	Stainless steel
<b>L/S 13 to 35 Standard pump heads</b>	
One	<a href="#">HL-07013-04</a>
Two	<a href="#">HL-07013-05</a>
Three	<a href="#">HL-07013-08</a>
Four	<a href="#">HL-07013-09</a>
<b>L/S 36 Standard pump head</b>	
One	<a href="#">HL-07036-01</a>
Two	<a href="#">HL-07036-02</a>

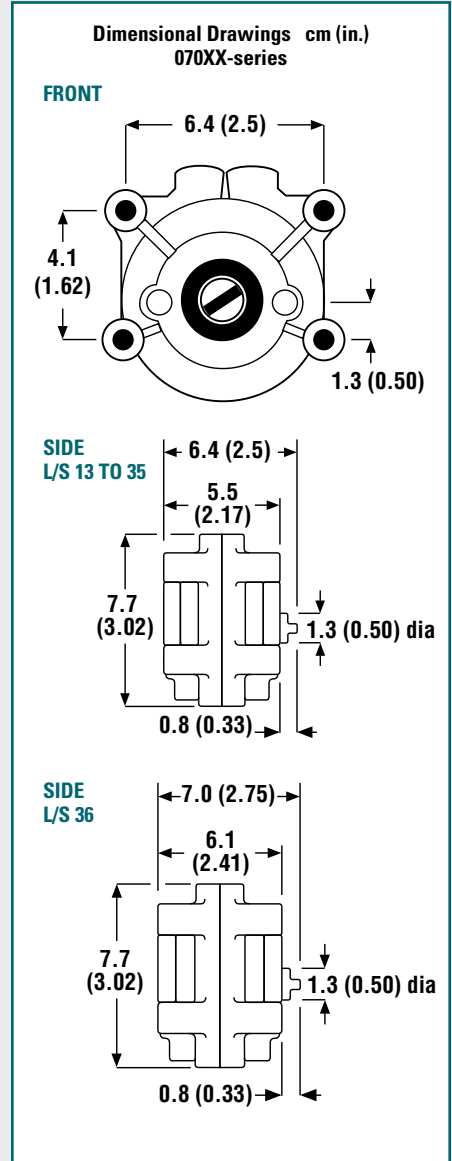

## NOTES

The design of the Standard pump head enables the most precise dispensing accuracy of any Masterflex pump head.

## HOW TO LOAD YOUR PUMP HEAD



1. Disassemble pump head. Load tubing.



2. Use the loading key (included) to ensure proper tubing alignment and tension.



3. Reassemble two halves and mount on drive.

L/S<sup>†</sup> TUBING ..... 68–73  
L/S<sup>†</sup> DRIVES ..... 74–107  
L/S<sup>†</sup> PUMP SYSTEMS ..... 108–117

ACCESSORIES ..... 160–171

TECHNICAL DATA ..... 172–206

## L/S® EASY-LOAD® 3 PUMP HEADS

### FEATURES/BENEFITS

- ▶ Deliver flow rates from 0.06 to 2900 mL/min
- ▶ Automatic tubing retention speeds tube loading and fluid changeover
- ▶ Same side tubing entry/exit for easy integration into space-limited applications
- ▶ Long occlusion surface prevents fluid backflow
- ▶ Included mounting plate adapts head to L/S drives
- ▶ Mount and operate head in any of four positions
- ▶ Locking tab secures head during operation in either direction of rotation
- ▶ Twist-lock mounting feature lets you mount and stack heads in seconds without tools or hardware
- ▶ Stackable for multiple-channel pumping and increased flow capacity
- ▶ Pump heads accept several tubing sizes

### SELECTION CRITERIA

1. Flow rate/tube size desired.
2. Materials of construction (rotor).
3. Compatibility with drives.

Silicone tubing (43 cm or 17") and mounting plate/adaptor supplied.

See specifications for more information.

**Order tubing and drives separately.**

### COMPATIBILITY WITH DRIVES

- ▶ Mount on all drives accepting Masterflex L/S pump heads

### NOTES

Use only Masterflex pump tubing with Masterflex pumps to ensure optimal performance. Use of other tubing may void applicable warranties.

### PUMP HOUSING SPECIFICATIONS

#### Polypropylene (PP)

- ▶ General-purpose applications
- ▶ Good protection from corrosive liquids/vapors
- ▶ Select from CRS/Buna N or 400-series SS/PTFE shielded ball bearing

#### ROLLER/ROTOR SPECIFICATIONS

#### Plated Cold-Rolled Steel (CRS)

- ▶ General-purpose applications
- ▶ Humidity: 0 to 90%
- ▶ Ball-bearing construction
- ▶ Continuous duty up to 600 rpm
- ▶ Precision and high-performance precision tubing versions

#### 300-Series Stainless Steel (SS)

- ▶ Corrosive fluids
- ▶ Humidity: 0 to 90%
- ▶ PTFE shielded ball-bearing construction (highest life expectancy)
- ▶ Continuous duty up to 600 rpm
- ▶ Precision and high-performance precision tubing versions

### MULTICHANNEL CAPABILITIES

- ▶ Mount up to four Easy-Load 3 pump heads on a single drive without tools or hardware



Easy-Load 3 pump head 77800-60

ISO9001:2008 CERTIFIED SUPPLIER 2 year warranty

### ORDERING INFORMATION

Pump tubing size	PP housing	
	CRS rotor	SS rotor
<b>For Precision tubing</b>		
L/S 13		
L/S 14		
L/S 16	<a href="#">HL-77800-50</a>	<a href="#">HL-77800-60</a>
L/S 25		
L/S 17		
L/S 18		
<b>For High-performance precision tubing</b>		
L/S 15		
L/S 24	<a href="#">HL-77800-52</a>	<a href="#">HL-77800-62</a>
L/S 35		
L/S 36		

PP = polypropylene CRS = cold-rolled steel SS = stainless steel



Tubing retainers automatically stretch and grip tubing when head is closed.

### L/S PUMP TUBING FLOW RATE INFORMATION

Order Masterflex L/S pump tubing separately on pages 68–73.

Tubing cross sections	L/S Precision pump tubing						L/S High-performance Precision pump tubing			
	L/S 13	L/S 14	L/S 16	L/S 25	L/S 17	L/S 18	L/S 15	L/S 24	L/S 35	L/S 36
Flow rate—mL/rev	0.06	0.21	0.8	1.7	2.8	3.8	1.7	2.8	3.8	4.8
mL/min @ 600 rpm	36	130	480	1000	1700	2300	1000	1700	2300	2900
Max pressure†	2.7 bar (40 psi)			2.4 bar (35 psi)	1.4 bar (20 psi)	1.0 bar (15 psi)	2.0 bar (30 psi)		1.7 bar (25 psi)	1.4 bar (20 psi)
Max vacuum†	660 mm Hg (26" Hg)				510 mm Hg (20" Hg)		660 mm Hg (26" Hg)			
Suction lift	8.8 m H <sub>2</sub> O (29 ft H <sub>2</sub> O)				6.7 m H <sub>2</sub> O (22 ft H <sub>2</sub> O)		8.8 m H <sub>2</sub> O (29 ft H <sub>2</sub> O)			

†Actual performance varies depending upon tubing materials—see pages 20–24 and 172–192 for more information.



## SPECIFICATIONS for L/S Easy-Load 3 Pump Heads

Catalog number	<a href="#">HL-77800-50</a> <a href="#">HL-77800-52</a>	<a href="#">HL-77800-60</a> <a href="#">HL-77800-62</a>
<b>Performance Specifications</b>		
Flow capacity	0.001 to 2900 mL/min (0.19 to 45.8 GPH) <sup>†</sup>	
Max rpm	600	
Number of rollers	3	
<b>Torque Specifications [a single head pumping water at 0 psi, 21.1°C (70°F)]<sup>‡</sup></b>		
Norprene®, PharMed® BPT	Starting torque	9.4 kg-cm (130 oz-in)
	Running torque	2.2 kg-cm (30 oz-in)
Tygon®, Viton®	Starting torque	15.8 kg-cm (220 oz-in)
	Running torque	3.6 kg-cm (50 oz-in)
C-FLEX®, Silicone	Starting torque	4.7 kg-cm (65 oz-in)
	Running torque	2.9 kg-cm (40 oz-in)
<b>Physical Specifications</b>		
Housing material	Polypropylene	
Rotor material	Cold-rolled steel	Stainless steel
Operating temperature	0 to 40°C (32 to 104°F)	
Shipping weight	0.9 kg (1.9 lb)	

<sup>†</sup>Depending on pump head and tubing selected. <sup>‡</sup>Maximum torque depends on tubing size.

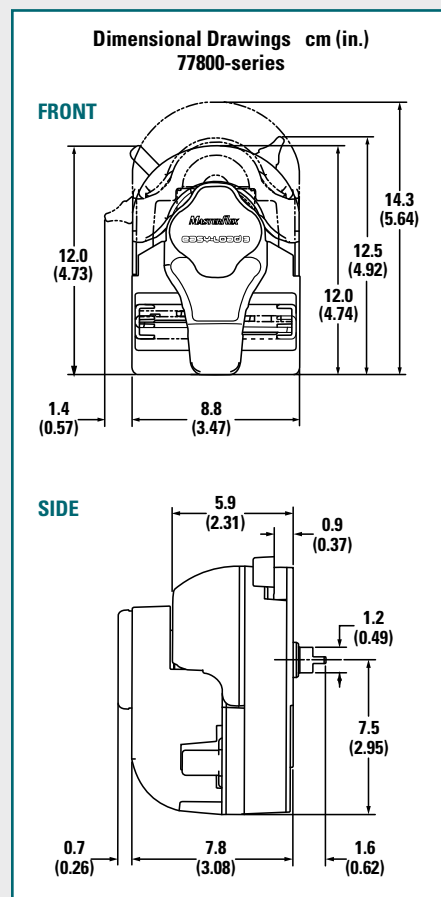

### Mounting Your Pump Head



Attach mounting plate to your L/S drive.



Twist and lock Easy-Load 3 pump head onto mounting plate.

### Stacking Your Pump Head



For multiple-channel applications, simply remove the front cover and . . .



Stack pump heads up to the limits of your drive.

### HOW TO LOAD YOUR PUMP HEAD



1. With head on drive, rotate activator lever counter-clockwise to open occlusion bed and tubing retainers.



2. Place tubing over rollers and through retainers.



3. Rotate activator lever clockwise to close occlusion bed and retainers.

### FREE TUBING TEST KIT!

#### Can't find your chemical in the tables?

Request your FREE tubing kit to test compatibility of your chemicals against different tubing formulations. Request item HL-00101-10.

**Call or go online to request your FREE test kit today!**



L/S TUBING .....	68-73
L/S DRIVES .....	74-107
L/S PUMP SYSTEMS .....	108-117

ACCESSORIES ..... 160-171

TECHNICAL DATA..... 172-206

## LS® EASY-LOAD® II PUMP HEADS

### FEATURES/BENEFITS

- ▶ Deliver flow rates from 0.001 to 2900 mL/min
- ▶ Four-roller design improves pressure performance, stability, and reduces pulsation
- ▶ Improved occlusion bed geometry reduces tubing wear, lengthens tubing life
- ▶ Over-center cam for quick tubing changes
- ▶ Adjustable and fixed occlusion available
- ▶ Adapts easily to OEM applications
- ▶ Stackable for multichannel pumping
- ▶ Automatic tubing retention eliminates manual adjustments
- ▶ Pump head accepts several tubing sizes

### SELECTION CRITERIA

1. Flow rate/tube size desired.
  2. Materials of construction (rotor).
  3. Compatibility with drives.
  4. Adjustable or fixed occlusion.
- ▶ 38 cm (15") of silicone tubing and single-channel mounting hardware supplied.

See specifications for more information.

**Order tubing and drives separately.**

### COMPATIBILITY WITH DRIVES

- ▶ Mount on most drives accepting Masterflex L/S pump heads

### PUMP HOUSING SPECIFICATIONS

#### Polyphenylene Sulfide (PPS)

- ▶ Best protection from corrosive liquids/vapors
- ▶ Nylon tubing retainers
- ▶ Select from CRS/Buna N or 400-series SS/PTFE shielded ball-bearing

#### FIXED/ADJUSTABLE OCCLUSION

##### Fixed Occlusion

- ▶ High flow rates at an economical price
- ▶ Factory calibrated for nominal occlusion

##### Adjustable Occlusion

- ▶ Increase occlusion to maximize pressure performance and obtain better suction lift
- ▶ Reduce occlusion to extend tubing life

### ROLLER/ROTOR SPECIFICATIONS

#### Plated Cold-Rolled Steel (CRS)

- ▶ General-purpose applications
- ▶ Humidity: 0 to 90%
- ▶ Ball-bearing construction
- ▶ Continuous duty up to 600 rpm
- ▶ Precision and High-performance precision tubing versions

#### 300-Series Stainless Steel (SS)

- ▶ Corrosive fluids
- ▶ Humidity: 0% to 90%
- ▶ PTFE shielded ball-bearing (highest life expectancy)
- ▶ Continuous duty up to 600 rpm
- ▶ Precision and High-performance precision tubing versions

### MULTICHANNEL CAPABILITIES

- ▶ Mount up to four Easy-Load II pump heads on a single drive
- ▶ Order hardware depending on number of pump heads to be mounted

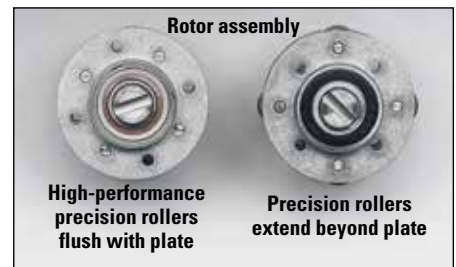

ISO9001:2008 CERTIFIED SUPPLIER **2** year warranty

### ORDERING INFORMATION

Pump tubing size	Fixed occlusion		Adjustable occlusion
	CRS rotor	SS rotor	SS rotor
<b>For Precision tubing</b>			
L/S 13			
L/S 14			
L/S 16	<a href="#">HL-77200-50</a>	<a href="#">HL-77200-60</a>	<a href="#">HL-77201-60</a>
L/S 25			
L/S 17			
L/S 18			
<b>For High-performance precision tubing</b>			
L/S 15			
L/S 24	<a href="#">HL-77200-52</a>	<a href="#">HL-77200-62</a>	<a href="#">HL-77201-62</a>
L/S 35			
L/S 36			

CRS = cold-rolled steel SS = stainless steel

### MOUNTING HARDWARE

Heads to be mounted	Catalog number/set
	Stainless steel
One	<a href="#">HL-77200-01</a>
Two	<a href="#">HL-77200-02</a>
Three	<a href="#">HL-77200-03</a>
Four	<a href="#">HL-77200-04</a>

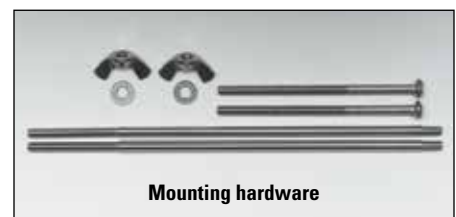

### L/S PUMP TUBING FLOW RATE INFORMATION

Order Masterflex L/S pump tubing separately on pages 68–73.

Tubing cross sections	L/S Precision pump tubing						L/S High-performance Precision pump tubing			
	L/S 13	L/S 14	L/S 16	L/S 25	L/S 17	L/S 18	L/S 15	L/S 24	L/S 35	L/S 36
Flow rate—mL/rev	0.06	0.21	0.8	1.7	2.8	3.8	1.7	2.8	3.8	4.8
mL/min @ 600 rpm	36	130	480	1000	1700	2300	1000	1700	2300	2900
Max pressure†	2.7 bar (40 psi)			2.4 bar (35 psi)	1.4 bar (20 psi)	1.0 bar (15 psi)	2.7 bar (40 psi)		2.4 bar (35 psi)	1.4 bar (20 psi)
Max vacuum†	660 mm Hg (26" Hg)				510 mm Hg (20" Hg)		660 mm Hg (26" Hg)			
Suction lift	8.8 m H <sub>2</sub> O (29 ft H <sub>2</sub> O)				6.7 m H <sub>2</sub> O (22 ft H <sub>2</sub> O)		8.8 m H <sub>2</sub> O (29 ft H <sub>2</sub> O)			

†Actual performance varies depending upon tubing materials—see pages 20–24 and 172–192 for more information.



## SPECIFICATIONS for L/S Easy-Load II Pump Heads

Catalog number	<a href="#">HL-77200-50</a> <a href="#">HL-77200-52</a>	<a href="#">HL-77200-60</a> <a href="#">HL-77200-62</a>	<a href="#">HL-77201-60</a> <a href="#">HL-77201-62</a>
<b>Performance Specifications</b>			
Flow capacity	0.001 to 2900 mL/min (9.48 to 45.82 GPH) <sup>†</sup>		
Max rpm	600		
Number of rollers	4		
<b>Torque Specifications* [a single head pumping water at 0 psi, 21°C (70°F)]</b>			
Norprene®, PharMed® BPT	Starting torque	12.9 kg-cm (180 oz-in)	
	Running torque	3.6 kg-cm (50 oz-in)	
Tygon®, Viton®	Starting torque	21.2 kg-cm (295 oz-in)	
	Running torque	4.3 kg-cm (60 oz-in)	
C-FLEX®, Silicone	Starting torque	5.8 kg-cm (80 oz-in)	
	Running torque	2.2 kg-cm (30 oz-in)	
<b>Physical Specifications</b>			
Housing material	Polyphenylene sulfide		
Rotor material	Cold-rolled steel	Stainless steel	
Operating temperature	0 to 40°C (32 to 104°F)		
Shipping weight	0.9 kg (1.9 lb)		

<sup>†</sup>Depending on pump head and tubing selected.

\*Maximum torque depends on tubing size. For complete torque data, see pages 172–192.

## Dimensional Drawings cm (in.) 77200-series, 77201-series, and 77202-series

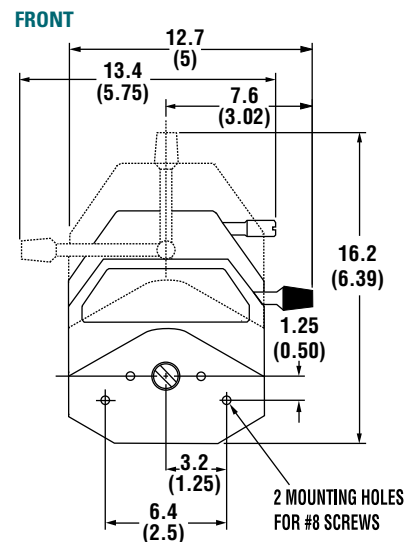

## SIDE

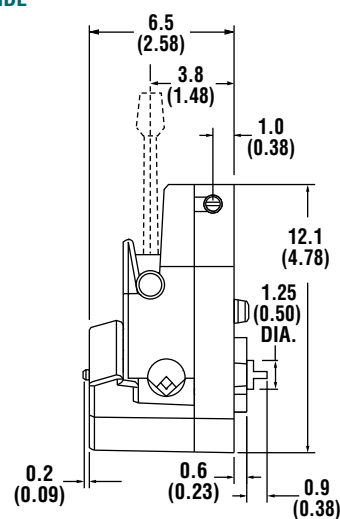

## L/S EASY-LOAD II TWO-CHANNEL PUMP HEADS

Identical to our Easy-Load II pump heads—except with two flow channels. Pump two channels simultaneously from one head (you must use the same size tubing in each channel), eliminating the need to stack heads. Each pump head accepts L/S 13, L/S 14, L/S 16, and L/S 25 tubing sizes in any formulation. Mount up to four two-channel pump heads on a single drive.

## ORDERING INFORMATION

Pump tubing size	mL per rev	Flow rates in mL/min at noted rpm (per channel)		Fixed occlusion	
		1 to 100	6 to 600	CRS rotor	SS rotor
L/S 13	0.06	0.06 to 6	0.36 to 36	<a href="#">HL-77202-50</a>	<a href="#">HL-77202-60</a>
L/S 14	0.21	0.21 to 21	1.3 to 130		
L/S 16	0.8	0.8 to 80	4.8 to 480		
L/S 25	1.7	1.7 to 170	10 to 1000		

CRS = cold-rolled steel SS = stainless steel



77202-50

## HOW TO LOAD YOUR PUMP HEAD



1. Rotate lever to left to open pump head. Load the correct size tubing.



2. Move lever to the right to close pump head.



3. Tubing is retained by automatic tubing retention on all models.



3. Adjustable occlusion available on 77201-60 and -62 models.

## NOTES

Use only Masterflex pump tubing with Masterflex pumps to ensure optimal performance. Use of other tubing may void applicable warranties.

L/S TUBING .....	68–73
L/S DRIVES .....	74–107
L/S PUMP SYSTEMS .....	108–117

ACCESSORIES ..... 160–171

TECHNICAL DATA ..... 172–206

## L/S® EASY-LOAD® PUMP HEADS

### FEATURES/BENEFITS

- ▶ Over-center cam design for fast tubing changes
- ▶ Deliver flow rates from 0.001 to 2300 mL/min
- ▶ Proprietary design and adjustable tubing retention feature
- ▶ Fixed occlusion for good flow repeatability
- ▶ Adapts easily to OEM applications
- ▶ Interchangeable
- ▶ Multichannel pumping
- ▶ Accepts several tubing sizes
- ▶ Models 07518-40 and 07518-42 are ATEX Zone 2 rated EEx II 3 G c IIC T6; NEC rated for Class I Division 2 Groups A, B, C, D T6

### SELECTION CRITERIA

1. Flow rate desired.
  2. Tubing size needed.
  3. Materials of construction (housing, rotor).
  4. Compatibility with drives.
- ▶ 38 cm (15") of silicone tubing and single-channel mounting hardware are supplied  
See specifications for more information.

### Order tubing and drives separately.

### COMPATIBILITY WITH DRIVES

- ▶ Mount on all drives accepting Masterflex L/S pump heads

### PUMP HOUSING SPECIFICATIONS

#### Polysulfone (PSF)

- ▶ General-purpose applications
- ▶ Select from CRS or 300-series SS/PTFE shielded ball-bearing

#### Polyphenylene Sulfide (PPS)

- ▶ Best protection from corrosive liquids/vapors
- ▶ 300-series SS/PTFE shielded ball-bearing



Pump head 07518-00 with polysulfone housing



Pump head 07518-60 with polyphenylene sulfide housing

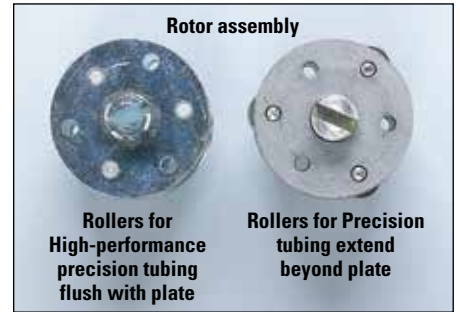

### ROLLER/ROTOR SPECIFICATIONS

#### Plated Cold-Rolled Steel (CRS)

- ▶ General-purpose applications
- ▶ Continuous duty up to 600 rpm
- ▶ Precision and High-performance precision versions

#### 300-Series Stainless Steel (SS)

- ▶ Corrosive fluids
- ▶ PTFE shielded ball-bearing (highest life expectancy)
- ▶ Continuous duty up to 600 rpm
- ▶ Precision and High-performance precision versions

ISO 9001:2008  
CERTIFIED SUPPLIER

2 year  
warranty

ATEX  
Zone 2  
07518-40, -42

### ORDERING INFORMATION

Pump tubing size	PSF housing		PPS housing	ATEX-approved PSF housing
	CRS rotor	SS rotor	SS rotor	SS rotor

#### For Precision tubing

L/S 13				
L/S 14				
L/S 16	<a href="#">HL-07518-00</a>	<a href="#">HL-07518-10</a>	<a href="#">HL-07518-60</a>	<a href="#">HL-07518-40</a>
L/S 25				
L/S 17				
L/S 18				

#### For High-performance precision tubing

L/S 15	<a href="#">HL-07518-02</a>	<a href="#">HL-07518-12</a>	<a href="#">HL-07518-62</a>	<a href="#">HL-07518-42</a>
L/S 24				

PSF= polysulfone PPS = polyphenylene sulfide  
CRS = cold-rolled steel SS = stainless steel

### L/S PUMP TUBING FLOW RATE INFORMATION

Order Masterflex L/S pump tubing separately on pages 68–73.

Tubing cross sections	L/S Precision pump tubing						L/S High-performance Precision pump tubing	
	L/S 13	L/S 14	L/S 16	L/S 25	L/S 17	L/S 18	L/S 15	L/S 24
Flow rate—mL/rev	0.06	0.21	0.8	1.92	2.8	3.8	1.7	2.8
mL/min @ 600 rpm	36	130	480	1150	1700	2300	1000	1700
Max pressure†	2.7 bar (40 psi)			2.4 bar (35 psi)	1.4 bar (20 psi)	1.0 bar (15 psi)	2.7 bar (40 psi)	
Max vacuum†	610 mm Hg (24" Hg)							
Suction lift	8.2 m H <sub>2</sub> O (26.8 ft H <sub>2</sub> O)							

†Actual performance varies depending upon tubing materials—see pages 20–24 and 172–192 for more information.





## SPECIFICATIONS for L/S Easy-Load Pump Heads

Catalog number	<a href="#">HL-07518-00</a> <a href="#">HL-07518-02</a>	<a href="#">HL-07518-10</a> <a href="#">HL-07518-12</a> <a href="#">HL-07518-40</a> <a href="#">HL-07518-42</a>	<a href="#">HL-07518-60</a> <a href="#">HL-07518-62</a>
----------------	--	--	--

### Performance Specifications

Flow capacity	0.001 to 2300 mL/min (0 to 36 GPH) <sup>†</sup>
Max rpm	600
Number of rollers	3

### Torque Specifications<sup>‡</sup> [a single pump head pumping water at 0 psi, 21°C (70°F)]

Norprene <sup>®</sup> , Pharmed <sup>®</sup> BPT	Starting torque	8.6 kg-cm (120 oz-in)
	Running torque	1.5 kg-cm (21 oz-in)
Tygon <sup>®</sup> , Viton <sup>®</sup>	Starting torque	13.0 kg-cm (180 oz-in)
	Running torque	2.5 kg-cm (35 oz-in)
C-FLEX <sup>®</sup> , Silicone	Starting torque	5.0 kg-cm (70 oz-in)
	Running torque	1.0 kg-cm (14 oz-in)

### Physical Specifications

Housing material	Polysulfone	Polyphenylene sulfide
Rotor material	Cold-rolled steel	Stainless steel
Operating temperature	0 to 40°C (32 to 104°F)	
Shipping weight	0.9 kg (1.9 lb)	

<sup>†</sup>Depending on pump head selected.

<sup>‡</sup>Actual torque depends on tubing size and formulation. For complete torque data, please see pages 172–192.

## MULTICHANNEL CAPABILITIES

- Mount up to four Easy-Load pump heads on a single drive depending on drive specifications.
- Order hardware based on number of pump heads to be mounted.



With single or multiple channels, you can change tubing in each channel without removing the Easy-Load pump head(s) from your drive.

## MOUNTING HARDWARE

Heads to be mounted	Catalog number/set
	Stainless steel
One	<a href="#">HL-07013-04</a>
Two	<a href="#">HL-07013-05</a>
Three	<a href="#">HL-07013-08</a>
Four	<a href="#">HL-07013-09</a>



Mounting hardware  
07013-04 (one) and 07013-05 (two channel)

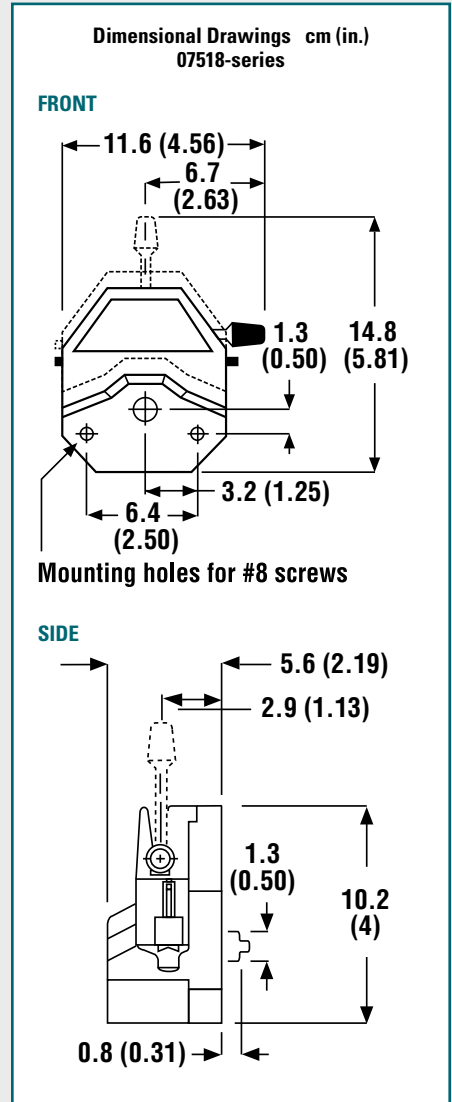

## NOTES

Use only Masterflex pump tubing with Masterflex pumps to ensure optimal performance. Use of other tubing may void applicable warranties.

## HOW TO LOAD YOUR PUMP HEAD



1. Rotate lever to left to open head. Load tubing.



2. Close head. Adjust side tubing retainers to hold tubing.

L/S <sup>®</sup> TUBING .....	68–73
L/S <sup>®</sup> DRIVES .....	74–107
L/S <sup>®</sup> PUMP SYSTEMS .....	108–117

ACCESSORIES ..... 160–171

TECHNICAL DATA..... 172–206

## L/S® HIGH-PERFORMANCE PUMP HEADS

### FEATURES/BENEFITS

- Delivers the highest flow rate of any L/S pump head
- Flow rates from 0.006 to 3400 mL/min
- To fit application needs, pump head can be mounted upright or on its side
- Tubing enters/exits same side of pump head
- Adjustable tubing retention holds tubing firmly in place
- Ideal for viscous fluid transfer
- Adapts easily to OEM applications
- Model 77250-82 is ATEX Zone 2 rated EEx II 3 G c IIC T6; NEC rated for Class I Division 2 Groups A, B, C, D T6

### SELECTION CRITERIA

- Flow rate/tube size desired.
  - Materials of construction.
  - Compatibility with drives.
- 38 cm (15") of E-LFL tubing and mounting hardware are supplied
- See specifications for more information.

Order tubing and drives separately.

### COMPATIBILITY WITH DRIVES

- Compatible with all Masterflex L/S drives that accept two or more pump heads

### PUMP HOUSING SPECIFICATIONS

- Rollers, bearings, rotor plates, and rotor shaft are made of stainless steel
- Occlusion bed: polyphenylene sulfide
- Retainer adjusting knob: polypropylene
- Main body: polyester

### ROLLER/ROTOR SPECIFICATIONS

#### Stainless Steel (SS)

- Operating temperatures from 0 to 40°C (32 to 104°F)
- Storage temperature range: -40 to 60°C (-40 to 140°F)
- Humidity: 95% maximum, 5% minimum (noncondensing)
- Continuous duty up to 600 rpm



High-performance pump head 77250-62



High-performance pump head 77250-62 shown mounted on an L/S modular drive 07557-00

ISO9001:2008  
CERTIFIED SUPPLIER

2 year  
warranty

ATEX  
Zone 2  
77250-82

### ORDERING INFORMATION

Pump tubing size	High-Performance pump head	ATEX-approved High-Performance pump head
L/S 15	<a href="#">HL-77250-62</a>	<a href="#">HL-77250-82</a>
L/S 24		
L/S 35		
L/S 36		
L/S 14HP		
L/S 16HP		
L/S 15HP		
L/S 24HP		

### MULTICHANNEL CAPABILITIES

- L/S High-Performance pump heads are not designed to be stacked

**SEE PAGE 117**

For Masterflex 100 psi high-pressure pump system.

### L/S PUMP TUBING FLOW RATE INFORMATION

Order Masterflex L/S pump tubing separately on pages 68–73; order high-pressure tubing on facing page.

Tubing cross sections	L/S High-performance Precision pump tubing				L/S High-pressure Precision pump tubing			
	L/S 15	L/S 24	L/S 35	L/S 36	L/S 14HP	L/S 16HP	L/S 15HP	L/S 24HP
Flow rate—mL/rev	1.8	3.0	4.3	5.8	0.3	0.9	1.7	2.4
mL/min @ 100 rpm	180	300	430	580	30	90	170	240
mL/min @ 600 rpm	1100	1800	2600	3400	Not recommended		Not recommended	
Max pressure†	2.7 bar (40 psi)		2.4 bar (35 psi)	1.4 bar (20 psi)	10.2 bar (150 psi)	8.5 bar (125 psi)	6.8 bar (100 psi)	5.5 bar (80 psi)
Max vacuum†	660 mm Hg (26" Hg)			610 mm Hg (24" Hg)	660 mm Hg (26" Hg)			
Suction lift	8.8 m H <sub>2</sub> O (29 ft H <sub>2</sub> O)			8.3 m H <sub>2</sub> O (27 ft H <sub>2</sub> O)	8.8 m H <sub>2</sub> O (29 ft H <sub>2</sub> O)			

†Actual performance varies depending upon tubing materials—see pages 20–24 and 172–192 for more information.



## SPECIFICATIONS for L/S High-Performance Pump Heads

Catalog number	<a href="#">HL-77250-62</a> , <a href="#">HL-77250-82</a>	
<b>Performance Specifications</b>		
Flow capacity	0.006 to 3400 mL/min (0 to 54 GPH)	
Max rpm	600	
Number of rollers	3	
<b>Torque Specifications [pumping water at 0 psi, 21°C (70°F)]†</b>		
Norprene®, PharMed® BPT	Starting torque	13.8 kg-cm (192 oz-in)
	Running torque	3.6 kg-cm (50 oz-in)
Tygon®, Viton®	Starting torque	11.5 kg-cm (160 oz-in)
	Running torque	5.4 kg-cm (75 oz-in)
C-FLEX®, Silicone	Starting torque	5.4 kg-cm (75 oz-in)
	Running torque	2.7 kg-cm (37 oz-in)
Norprene® HP, PharMed® BPT HP	Starting torque	43.9 kg-cm (610 oz-in)
	Running torque	7.2 kg-cm (100 oz-in)
<b>Physical Specifications</b>		
Roller, bearings, rotor plates, and rotor shaft materials	Stainless steel	
Operating temperature	0 to 40°C (32 to 104°F)	
Shipping weight	1.6 kg (3.5 lb)	

†For L/S 36 tubing.

## ACCESSORIES

[HL-77250-01](#) Replacement mounting hardware, stainless steel.



## NOTES

Use only Masterflex pump tubing with Masterflex pumps to ensure optimal performance. Use of other tubing may void applicable warranties.

## ORDERING INFORMATION for L/S High-Pressure Pump Tubing

Tubing size	Catalog number	Tubing ID	Flow range (1 to 100 rpm)	Maximum pressure (continuous)	Length/pk
<b>PharMed BPT</b>					
L/S 14HP	<a href="#">HL-95664-14</a>	1/16"	0.3 to 30 mL/min	10.2 bar (150 psi)	7.6 m (25 ft)
L/S 16HP	<a href="#">HL-95664-16</a>	1/8"	0.9 to 90 mL/min	8.5 bar (125 psi)	
L/S 15HP	<a href="#">HL-95664-15</a>	3/16"	1.7 to 170 mL/min	6.8 bar (100 psi)	
L/S 24HP	<a href="#">HL-95664-24</a>	1/4"	2.4 to 240 mL/min	5.5 bar (80 psi)	
<b>Norprene</b>					
L/S 16HP	<a href="#">HL-06504-16</a>	1/8"	0.9 to 90 mL/min	8.5 bar (125 psig)	7.6 m (25 ft)
L/S 15HP	<a href="#">HL-06504-15</a>	3/16"	1.7 to 170 mL/min	6.8 bar (100 psig)	

## HOW TO LOAD YOUR PUMP HEAD



1. Rotate tubing retainer knob counter-clockwise to release retainer, then open cover. Lift latch to open occlusion bed.



2. Insert tubing into occlusion bed, so that the tubing ends extend out of the tubing entrance and exit as shown.



3. Press occlusion bed against tubing and snap latch closed. Pull the tubing snug around rotor, close cover, and rotate tubing retainer knob clockwise. Tighten tubing retainer knob to secure tubing.

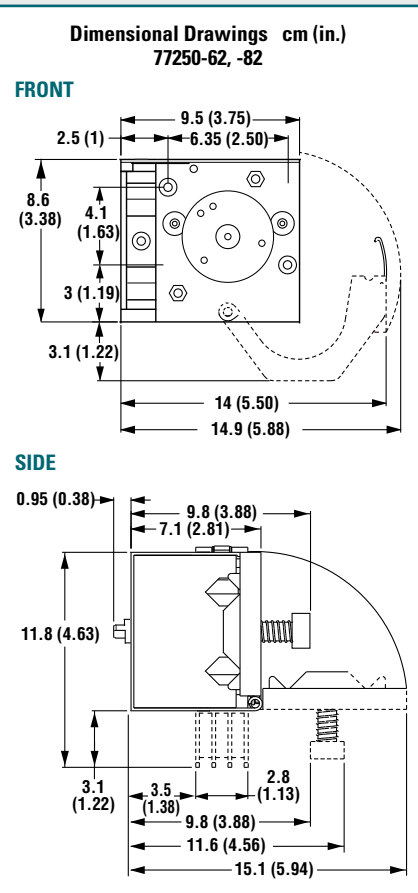

## FREE TUBING TEST KIT!

Can't find your chemical in the tables?

Request your FREE tubing kit to test compatibility of your chemicals against different tubing formulations. Request item HL-00101-10.

**Call or go online to request your FREE test kit today!**



L/S TUBING .....	68-73
L/S DRIVES .....	74-107
L/S PUMP SYSTEMS .....	108-117

ACCESSORIES..... 160-171

TECHNICAL DATA..... 172-206

## L/S® PTFE-TUBING PUMP HEAD

### FEATURES/BENEFITS

- ▶ Flow range: 0.06 to 65 mL/min
- ▶ Transfer aggressive organic solvents and maintain fluid purity
- ▶ Transfer liquid containing small particulates
- ▶ Excellent chemical compatibility
- ▶ Deliver a wide range of flow rates at pressures up to 100 psi
- ▶ Adjustable occlusion
- ▶ Use precision-molded tubing sets

### SELECTION CRITERIA

- ▶ Flow rate desired.
  - ▶ Tube size required.
  - ▶ Compatibility with drives.
- See specifications for more information.

**Order tubing and drives separately.**

### COMPATIBILITY WITH DRIVES

- ▶ Mount on all Masterflex L/S drives that accept two or more pump heads

### PUMP HOUSING SPECIFICATIONS

- ▶ Pump body, bearing support, and rotor plates are anodized aluminum
- ▶ Rotor shaft, bearing, rollers, and hardware are stainless steel
- ▶ Occlusion bed: acetal
- ▶ ABS plastic occlusion knob

### NOTES

Use only Masterflex PTFE-tubing sets with the Masterflex PTFE-tubing pump head to ensure optimal performance. Use of other tubing may void applicable warranties.

### ROLLER/ROTOR SPECIFICATIONS

#### 300-Series Stainless Steel (SS)

- ▶ Humidity from 0% to 100%
- ▶ Operating temperature from 0 to 40°C (32 to 104°F)
- ▶ Fluid temperature from 0 to 100°C (32 to 212°F)
- ▶ Ball-bearing construction
- ▶ Continuous duty up to 300 rpm



PTFE-tubing pump head 77390-00



PTFE tubing pump head 77390-00 shown on L/S variable-speed console drive 07528-20 is ideal for transferring aggressive organic solvents.

ISO9001:2008  
CERTIFIED SUPPLIER

2 year  
warranty

### ORDERING INFORMATION

Catalog number	Description
<a href="#">HL-77390-00</a>	L/S PTFE-tubing pump head only

## PTFE-TUBING SETS AND ACCESSORIES

**PTFE-Tubing Sets** include two 38 cm (15") lengths and cannot be substituted with ordinary PTFE tubing. Choose compression fittings below to adapt tubing sets to your system.

[HL-77390-50](#) PTFE-tubing set, 4-mm OD, 2-mm ID. Set of two 38-m (15") lengths.

[HL-77390-60](#) PTFE-tubing set, 6-mm OD, 4-mm ID. Set of two 38-m (15") lengths.

### For 4-mm OD PTFE-Tubing Sets

[HL-31321-61](#) Straight connector, 2.8 bar (40 psi) max pressure

[HL-31321-62](#) Male pipe adapter with 1/8" NPT(M) connection

[HL-31321-63](#) Male pipe adapter with 1/4" NPT(M) connection

[HL-06605-53](#) PTFE extension tubing, 4-mm OD. Pack of 7.6 m (25 ft)

### For 6-mm OD PTFE-Tubing Sets

[HL-31321-64](#) Straight connector, 9.2 bar (135 psi) max pressure

[HL-31321-43](#) Male pipe adapter with 1/4" NPT(M) connection

[HL-06605-54](#) PTFE extension tubing, 6-mm OD. Pack of 7.6 m (25 ft)

[HL-31321-49](#) Tubing grooving tool. Use when connections must withstand 40 psi (2.8 bar) or greater



PTFE tubing sets, PTFE extension tubing, and straight connectors.



## SPECIFICATIONS for L/S PTFE-Tubing Pump Head

Catalog number	HL-77390-00	
<b>Performance Specifications</b>		
Flow capacity	4-mm OD tubing	0.06 to 17 mL/min (0 to 0.27 GPH)
	6-mm OD tubing	0.25 to 65 mL/min (0 to 1.1 GPH)
Max rpm	300	
Number of rollers	6	
Vacuum lift	2.4 m H <sub>2</sub> O (8 ft H <sub>2</sub> O)	
<b>Maximum Torque [pumping water at 0 psi, 21°C (70°)]</b>		
PTFE tubing	12.9 kg-cm (180 oz-in)	
<b>Physical Specifications</b>		
Pump body, bearing support, and rotor plates material	Anodized aluminum	
Rotor shaft, bearings, rollers, and hardware material	Stainless steel	
Reversible	Yes	
Run dry	No†	
Operating temperature	0 to 40°C (32 to 104°F)	
Shipping weight	1.5 kg (3.3 lb)	

†Do not pump gases or run dry for long periods of time; run dry to prime only.

## COMPLETE L/S PTFE-TUBING PUMP SYSTEM

### Applications

- ▶ Pumping high-purity fluids
- ▶ Transfer of aggressive chemicals
- ▶ Chemical feed and metering
- ▶ Filtration

### Benefits

- ▶ Flow rate: 0.75 to 65 mL/min; pressure up to 100 psi (6.9 bar)
- ▶ Low-pulsation, six-roller pump head
- ▶ Continuous-duty drive displays speed (rpm) and direction

**Complete system includes:** L/S PTFE tubing pump head 77390-00, 6-mm OD PTFE tube set 77390-60, L/S 300 rpm variable-speed console drive 07528-20, and two ¼" NPT(M) pipe adapters.



Catalog number	Power
HL-77912-10	90 to 260 VAC, 50/60 Hz

## Dimensional Drawings cm (in.) 77390-00

### FRONT

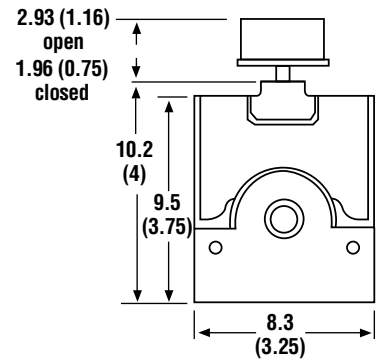

### SIDE

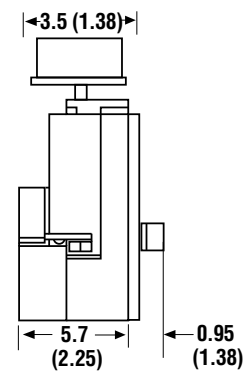

## Decay of Initial Flow vs. Time at 300 rpm

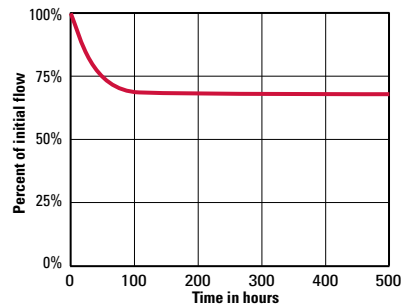

## HOW TO LOAD YOUR PUMP HEAD



1. Rotate locking ring then rotate the knob on top of the pump counterclockwise. Lift occlusion bed by sliding it out the front of the body assembly.



2. Install the PTFE tubing assembly in the occlusion bed groove.



3. Slide the occlusion assembly back onto the body assembly and tighten knob.

L/S TUBING .....	68-73
L/S DRIVES .....	74-107
L/S PUMP SYSTEMS .....	108-117

ACCESSORIES ..... 160-171

TECHNICAL DATA ..... 172-206

## L/S® MULTICHANNEL PUMP HEADS FOR MICROBORE PUMP TUBING

### FEATURES/BENEFITS

- Four- or eight-channel heads are stackable for up to 32 synchronous flow channels
- Deliver flow rates from 0.00005 to 200 mL/min per channel (flow rates depend on drive rpm and tubing size)
- Six rollers deliver low-pulsation flow
- Excellent between-channel accuracy
- Anodized aluminum and stainless steel construction for durability and reliable, continuous-duty operation up to 600 rpm
- Two-stop tubing sets are easy to load with no occlusion or retention adjustment—order tubing sets separately below
- Accept microbore two-stop tube sets from 0.19 to 2.79 mm ID for a wide flow range

**Note:** Multichannel pump heads require two-stop tube sets and cannot be loaded with continuous tubing.

### SELECTION CRITERIA

- Flow rate and tubing size desired.
  - Number of channels needed.
  - Compatibility with drives.
- Mounting hardware and hex key tool included. See specifications for more information.

**Order tubing and drives separately.**

### COMPATIBILITY WITH DRIVES

- Mount on all Masterflex L/S drives that accept two or more pump heads; 1/10 hp minimum

### PUMP HOUSING SPECIFICATIONS

- Black anodized aluminum frame and gray, hardcoat anodized aluminum occlusion beds

### ROLLER/ROTOR SPECIFICATIONS

- Rollers, bearings, rotor plates, and rotor shaft are made of 303 stainless steel
- Good protection from corrosive liquids/vapors
- Humidity: 10 to 90% noncondensing
- Shielded stainless steel ball bearings
- Continuous duty up to 600 rpm



**Multichannel pump head 07534-04 for microbore tubing**



**Six rollers deliver accurate, low-pulsation flow.**



**Stack heads for up to 32 channels.**

### MULTICHANNEL CAPABILITIES

- Stack heads up to the limits detailed under "Specifications" on facing page
- Mounting hardware and hex key tool are included with each pump head; hardware set attaches head to drive and/or head to head

ISO9001:2008  
CERTIFIED SUPPLIER

**2** year  
warranty

### ORDERING INFORMATION

Catalog number	Number of channels
<b>Multichannel pump heads for microbore pump tubing, 0.19 to 2.79 mm ID</b>	
<a href="#">HL-07534-04</a>	4
<a href="#">HL-07534-08</a>	8

### ACCESSORIES

[HL-07534-01](#) Replacement mounting hardware set, includes four mounting screws and hex key tool.

### MICROBORE TWO-STOP PUMP TUBING SET FLOW RATES & ORDERING INFORMATION

**Flow Rate Information (mL/min per channel using microbore two-stop tubing sets below)**

Drive rpm	Microbore pump tubing					
	0.19 mm ID	0.25 mm ID	0.89 mm ID	1.42 mm ID	2.06 mm ID	2.79 mm ID
1 to 100	0.0026 to 0.26	0.0053 to 0.53	0.054 to 5.4	0.12 to 12	0.23 to 23	0.35 to 35
6 to 600	Not recommended†	Not recommended†	0.30 to 30	0.67 to 67	1.3 to 130	2.0 to 200

†Maximum recommended speed for these tubing sizes is 300 rpm.

### Microbore Two-Stop Tubing Set Ordering Information

Tubing ID (mm)	Platinum-cured silicone	Santoprene®	Tygon® E-LFL	Viton®
0.19	—	—	<a href="#">HL-06447-10</a>	—
0.25	—	<a href="#">HL-06431-12</a>	<a href="#">HL-06447-12</a>	—
0.89	<a href="#">HL-06421-26</a>	<a href="#">HL-06431-26</a>	<a href="#">HL-06447-26</a>	<a href="#">HL-96428-26</a>
1.42	<a href="#">HL-06421-34</a>	<a href="#">HL-06431-34</a>	<a href="#">HL-06447-34</a>	<a href="#">HL-96428-34</a>
2.06	<a href="#">HL-06421-42</a>	<a href="#">HL-06431-42</a>	<a href="#">HL-06447-42</a>	<a href="#">HL-96428-42</a>
2.79	<a href="#">HL-06421-48</a>	<a href="#">HL-06431-48</a>	<a href="#">HL-06447-48</a>	<a href="#">HL-96428-48</a>
Qty/pk	6	12	12	12

Order microbore extension tubing on pages 34 and 36.



## SPECIFICATIONS for L/S Multichannel Pump Heads

Catalog number	<a href="#">HL-07534-04</a>		<a href="#">HL-07534-08</a>	
<b>Performance Specifications</b>				
Flow capacity per channel	0.00005 to 200 mL/min (0 to 3.2 GPH)			
Number of channels	4		8	
Max number of channels with stacked heads†	100-rpm drive	32		
	600-rpm drive	28		
Max rpm	600			
Number of rollers	6			
<b>Torque Specifications [a single pump head pumping water at 0 psi, 21°C (70°F)]‡</b>				
Santoprene®	Starting torque	7.2 kg-cm (100 oz-in)	9.0 kg-cm (125 oz-in)	
	Running torque	2.2 kg-cm (30 oz-in)	2.9 kg-cm (40 oz-in)	
PVC	Starting torque	10.8 kg-cm (150 oz-in)	13.7 kg-cm (190 oz-in)	
	Running torque	6.1 kg-cm (85 oz-in)	7.9 kg-cm (110 oz-in)	
Silicone	Starting torque	4.3 kg-cm (60 oz-in)	5.0 kg-cm (70 oz-in)	
	Running torque	1.8 kg-cm (25 oz-in)	2.2 kg-cm (30 oz-in)	
<b>Physical Specifications</b>				
Housing material	Anodized aluminum			
Rotor material	Stainless steel			
Operating temperature	0 to 40°C (32 to 104°F)			
Shipping weight	1.8 kg (4 lb)			2.3 kg (5 lb)

†With softer formulations such as silicone; max number of channels will be less with firmer tubing.  
‡All channels loaded with specified tubing formulations.

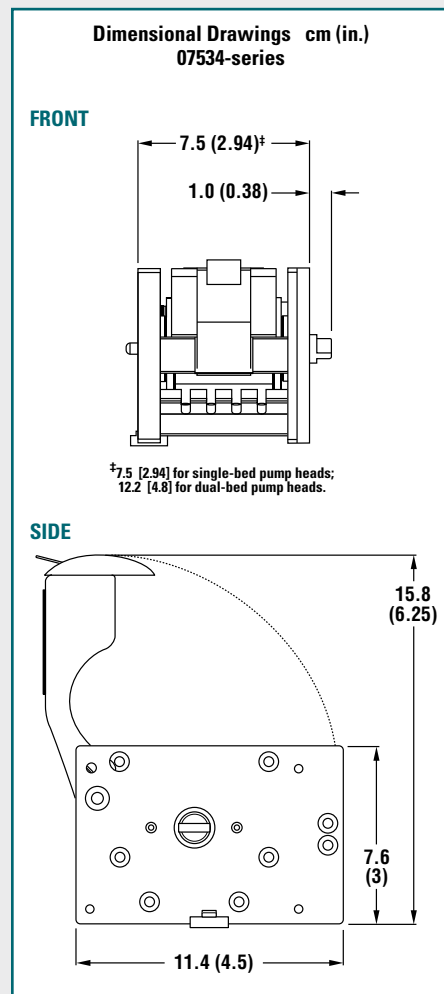

## COMPLETE L/S MULTICHANNEL PUMP SYSTEM

### Applications

- Multichannel, low-volume dispensing
- Meter fluids through multiple lines

### Benefits

- Flow rate: 0.35 to 35 mL/min per channel
- Synchronous flow from four separate channels
- Low-pulsation, six-roller pump head
- Continuous-duty drive displays speed (rpm) and direction

**Complete system includes:** L/S multichannel pump head 07534-04, 2.79 mm ID PVC tube set 06416-48, L/S 100-rpm variable-speed console drive 07528-30.



Drive is



See pages 110 and 112 for more complete L/S Multichannel Pump Systems

## FOR THE LATEST...

Masterflex technical resources, see

- ColeParmer.com
- Masterflex.com

## HOW TO LOAD YOUR PUMP HEAD



1. Release latch and open occlusion bed; place tubing over rollers and thread ends through retainer slots.



2. Hook left side tubing stop underneath retainer slot.



3. Stretch tubing and hook right side stop underneath retainer slot. Close and latch occlusion bed.

L/S TUBING .....	68-73
L/S DRIVES .....	74-107
L/S PUMP SYSTEMS .....	108-117

ACCESSORIES ..... 160-171

TECHNICAL DATA..... 172-206

## L/S® MULTICHANNEL PUMP HEADS FOR L/S® PUMP TUBING

### FEATURES/BENEFITS

- Two-, four-, or eight-channel heads are stackable for up to 24 synchronous flow channels
- Deliver flow rates from 0.0009 to 2300 mL/min per channel
- Six-roller heads deliver smooth, low-pulsation flow; three-roller heads offer higher flow rates
- Excellent between-channel accuracy makes these heads ideal for multi-channel dispensing applications
- Anodized aluminum and stainless steel construction for durability and reliable, continuous-duty operation up to 600 rpm
- Two-stop tubing sets are easy to load with no occlusion or retention adjustment—order tubing sets on facing page
- Accept Masterflex® L/S Precision and High-performance precision pump tubing sizes L/S 13, L/S 14, L/S 16, L/S 15, L/S 24, and L/S 35

**Note:** Multichannel pump heads require two-stop tube sets and cannot be loaded with continuous tubing.

### SELECTION CRITERIA

- Flow rate and tubing size desired.
- Number of channels needed.
- Compatibility with drives.

Mounting hardware, hex key tool included.  
See specifications for more information.

**Order tubing and drives separately.**

### COMPATIBILITY WITH DRIVES

- Mount on all Masterflex L/S drives that accept two or more pump heads; 1/10 hp minimum

### PUMP HOUSING SPECIFICATIONS

- Black anodized aluminum frame and gray, hardcoat anodized aluminum occlusion beds

### ROLLER/ROTOR SPECIFICATIONS

- Good protection from corrosive liquids/vapors
- Humidity: 10 to 90% noncondensing
- Shielded stainless steel ball bearings
- Continuous duty up to 600 rpm
- Rollers, bearings, rotor plates, and rotor shaft are made of 303 stainless steel



Multichannel pump head 07535-08 for L/S Precision pump tubing



Multichannel pump head 07536-04 for L/S High-performance precision pump tubing



Stack heads for up to 24 channels.

### MULTICHANNEL CAPABILITIES

- Stack heads up to the limits detailed under "Specifications" on facing page
- Mounting hardware and hex key tool are included with each pump head; hardware set attaches head to drive and/or head to head

ISO 9001:2008  
CERTIFIED SUPPLIER

2 year  
warranty

### ORDERING INFORMATION







Catalog number	Number of channels
<b>Multichannel pump heads for Precision pump tubing, sizes L/S 13, L/S 14, L/S 16</b>	
<a href="#">HL-07535-04</a>	4
<a href="#">HL-07535-08</a>	8
<b>Multichannel pump heads for High-performance Precision pump tubing, sizes L/S 15, L/S 24, L/S 35</b>	
<a href="#">HL-07536-02</a>	2
<a href="#">HL-07536-04</a>	4

### ACCESSORIES

**HL-07534-01** Replacement mounting hardware set, includes four mounting screws and hex key tool

### L/S PUMP TUBING FLOW RATE INFORMATION

Order Masterflex L/S two-stop Precision pump tubing sets on facing page; order L/S Precision extension tubing on pages 68–73.

Tubing cross sections	L/S Precision pump tubing			L/S high-performance Precision pump tubing		
						
	L/S 13	L/S 14	L/S 16	L/S 15	L/S 24	L/S 35
Flow rate—mL/rev	0.045	0.16	0.47	1.6	2.8	3.8
mL/min @ 600 rpm	27	96	280	1000	1700	2300
Max pressure <sup>†</sup>	2.7 bar (40 psi)					2.4 bar (35 psi)
Max vacuum <sup>†</sup>	660 mm Hg (26" Hg)					
Suction lift	8.8 m H <sub>2</sub> O (29 ft H <sub>2</sub> O)					

<sup>†</sup>Actual performance varies depending upon tubing materials—see pages 20–24 and 172–192 for more information.





## SPECIFICATIONS for L/S Multichannel Pump Heads

Catalog number		<a href="#">HL-07535-04</a>	<a href="#">HL-07535-08</a>	<a href="#">HL-07536-02</a>	<a href="#">HL-07536-04</a>
<b>Performance Specifications</b>					
Flow capacity per channel		0.0009 to 280 mL/min (0 to 4.4 GPH)		0.032 to 2300 mL/min (0 to 36 GPH)	
Number of channels		4	8	2	4
Max number of channels with stacked heads <sup>†</sup>	100-rpm drive	24		12	
	600-rpm drive	12		6	
Max rpm		600		600	
Number of rollers		6		3	
<b>Torque Specifications [a single pump head pumping water at 0 psi, 21°C (70°F)]<sup>‡</sup></b>					
PharMed® BPT	Starting torque	19.8 kg-cm (275 oz-in)	32.4 kg-cm (450 oz-in)	20.5 kg-cm (285 oz-in)	37 kg-cm (515 oz-in)
	Running torque	3.6 kg-cm (50 oz-in)	5.4 kg-cm (75 oz-in)	4.0 kg-cm (55 oz-in)	6.8 kg-cm (95 oz-in)
Tygon®, Viton®	Starting torque	25.1 kg-cm (350 oz-in)	33.5 kg-cm (465 oz-in)	21.2 kg-cm (295 oz-in)	37.4 kg-cm (520 oz-in)
	Running torque	8.3 kg-cm (115 oz-in)	11.2 kg-cm (155 oz-in)	6.8 kg-cm (95 oz-in)	12.9 kg-cm (180 oz-in)
Silicone	Starting torque	11.9 kg-cm (165 oz-in)	16.9 kg-cm (235 oz-in)	12.9 kg-cm (180 oz-in)	20.9 kg-cm (290 oz-in)
	Running torque	2.5 kg-cm (35 oz-in)	4.0 kg-cm (55 oz-in)	2.9 kg-cm (40 oz-in)	5.4 kg-cm (75 oz-in)
<b>Physical Specifications</b>					
Housing material		Anodized aluminum			
Rotor material		Stainless steel			
Operating temperature		0 to 40°C (32 to 104°F)			
Shipping weight		1.8 kg (4 lb)	2.3 kg (5 lb)	1.8 kg (4 lb)	2.3 kg (5 lb)

<sup>†</sup>With softer formulations such as silicone; max number of channels will be less with firmer tubing.  
<sup>‡</sup>All channels loaded with specified tubing formulation.

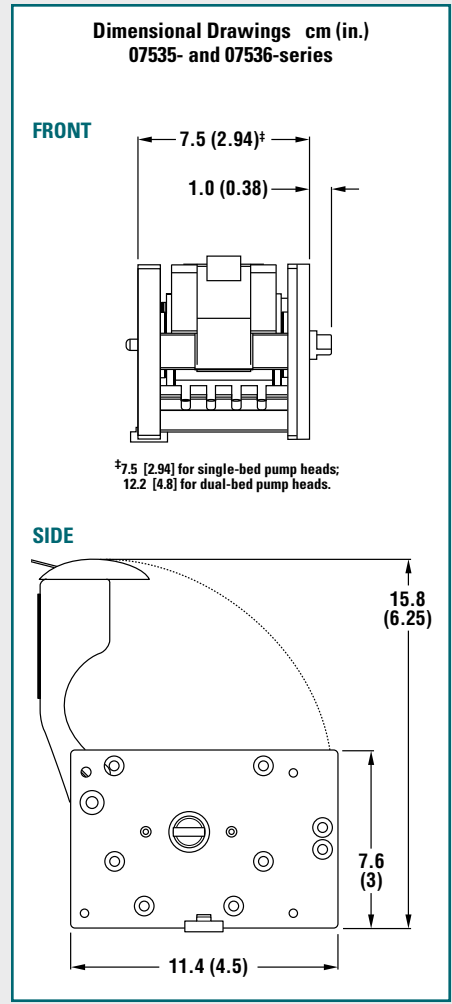

## HOW TO LOAD YOUR PUMP HEAD



**1. Release latch and open occlusion bed; place tubing over rollers and thread ends through retainer slots.**



**2. Hook left side tubing stop underneath retainer slot.**



**3. Stretch tubing and hook right side stop underneath retainer slot. Close and latch occlusion bed.**

L/S TUBING .....	68-73
L/S DRIVES .....	74-107
L/S PUMP SYSTEMS .....	108-117

ACCESSORIES..... 160-171

TECHNICAL DATA..... 172-206

## L/S TWO-STOP PUMP TUBING SETS ORDERING INFORMATION

Pump tubing formulation	L/S Precision pump tubing			L/S High-performance Precision pump tubing		
	L/S 13	L/S 14	L/S 16	L/S 15	L/S 24	L/S 35
Tygon® E-FL <b>NEW</b>	<a href="#">HL-06447-13</a>	<a href="#">HL-06447-14</a>	<a href="#">HL-06447-16</a>	<a href="#">HL-06447-15</a>	<a href="#">HL-06447-24</a>	<a href="#">HL-06447-35</a>
Silicone (platinum-cured)	<a href="#">HL-06421-13</a>	<a href="#">HL-06421-14</a>	<a href="#">HL-06421-16</a>	<a href="#">HL-06421-15</a>	<a href="#">HL-06421-24</a>	<a href="#">HL-06421-35</a>
BioPharm Plus silicone (platinum-cured)	<a href="#">HL-96116-13</a>	<a href="#">HL-96116-14</a>	<a href="#">HL-96116-16</a>	<a href="#">HL-96116-15</a>	<a href="#">HL-96116-24</a>	<a href="#">HL-96116-35</a>
PharMed® BPT	<a href="#">HL-96114-13</a>	<a href="#">HL-96114-14</a>	<a href="#">HL-96114-16</a>	<a href="#">HL-96114-15</a>	<a href="#">HL-96114-24</a>	<a href="#">HL-96114-35</a>
Chem-Durance® Bio	<a href="#">HL-96117-13</a>	<a href="#">HL-96117-14</a>	<a href="#">HL-96117-16</a>	<a href="#">HL-96117-15</a>	<a href="#">HL-96117-24</a>	<a href="#">HL-96117-35</a>
Viton®	<a href="#">HL-96428-13</a>	<a href="#">HL-96428-14</a>	<a href="#">HL-96428-16</a>	<a href="#">HL-96428-15</a>	<a href="#">HL-96428-24</a>	<a href="#">HL-96428-35</a>
Qty/pk	8	8	8	4	4	4

## L/S® MULTICHANNEL CARTRIDGE PUMP HEADS

### FEATURES/BENEFITS

- ▶ Synchronous multichannel pumping
- ▶ Deliver flow rates from 0.005 to 1700 mL/min per channel with Masterflex L/S® or microbore tubing (flow rates depend on drive rpm and tubing size)
- ▶ Use 4 large cartridges, 8 small cartridges, or any combination of both
- ▶ Up to eight channels with a single head
- ▶ Use one cartridge or fill the pump head
- ▶ Each cartridge is individually adjustable
- ▶ Precision molded housing and tubing cavity
- ▶ Adapts easily to OEM applications

### COMPATIBILITY WITH DRIVES

- ▶ Mount on most drives accepting Masterflex L/S pump heads

For more information, see specific drive pages.

### SELECTION CRITERIA

1. Flow rate, tubing size desired.
  2. Number of channels needed.
  3. Drive compatibility.
- See specifications for more information.  
**Order tubing and drives separately.**

### PUMP HOUSING SPECIFICATIONS

#### Molded Polysulfone Body

- ▶ General-purpose applications
- ▶ Adjustable foot provided for head support

### ROLLER/ROTOR SPECIFICATIONS

#### 300-Series Stainless Steel (SS) for 07519-06

#### Anodized Aluminum for 07519-05

- ▶ General-purpose applications
  - ▶ Buna N shielded ball-bearing construction
  - ▶ Continuous duty up to 600 rpm
- See specifications for maximum drive rpm.

### CARTRIDGE SPECIFICATIONS

#### Polycarbonate and Glass-Filled Nylon

- ▶ No tools required/mechanically stable
- ▶ Anodized aluminum occlusion knob

#### Tangential Occlusion

- ▶ Better flow performance
- ▶ Fine tune flow rates ±5%
- ▶ Flow characteristics virtually the same in each direction of rotation
- ▶ Increase occlusion for priming/greater pressure
- ▶ Decrease occlusion to extend tubing life
- ▶ Index scale on cartridge to reference set occlusion
- ▶ Use microbore and Masterflex L/S Precision tubing sizes

ISO9001:2008  
CERTIFIED SUPPLIER

2 year  
warranty

### ORDERING INFORMATION

#### Pump Heads

Catalog number	Max number of cartridges accepted <sup>†</sup>	Gear reduction	Max drive speed
<b>Three-roller pump head</b>			
<a href="#">HL-07519-05</a>	4 large or 8 small	1:1	600
<b>Four-roller pump head</b>			
<a href="#">HL-07519-06</a>	4 large or 8 small	1:1	600

<sup>†</sup>Pump heads accept both large and small cartridges—one large cartridge occupies the same space as two small ones. Use 4 large cartridges, 8 small cartridges, or any combination of both.

#### Cartridges

Catalog number	Tubing sizes accepted
<b>Large cartridge</b>	
<a href="#">HL-07519-70</a>	Masterflex L/S 14, 16, 25, 17 <sup>†</sup>
<b>Small cartridge</b>	
<a href="#">HL-07519-80</a>	Microbore two-stop tubing sets, 0.89 mm and larger; or Masterflex tubing sizes L/S 13 and L/S 14

<sup>†</sup>Only C-FLEX® and silicone tubing formulations are recommended for L/S 17.



Three-roller pump head  
07519-05



Four-roller pump head  
07519-06

### NOTES

Use only Masterflex pump tubing with Masterflex pumps to ensure optimal performance. Use of other tubing may void applicable warranties.

### SPECIFICATIONS & FLOW RATE INFORMATION (mL/MIN PER CHANNEL)

Pump head model	No. of rollers	Maximum no. of cartridges accepted	Gear ratio	Drive rpm	Pump tubing sizes (Order microbore two-stop tubing sets on page 57 and Masterflex pump tubing on pages 68–73.**)							
					0.19 mm ID	0.25 mm ID	0.89 mm ID	1.42 mm ID	2.06 mm ID	2.79 mm ID		
<b>Using microbore two-stop tubing sets</b>												
<a href="#">HL-07519-05</a>	3	4 large or 8 small	1:1	6 to 600	Not recommended	Not recommended	0.44 to 44	1.0 to 100	2.2 to 220	3.8 to 380		
				0.1 to 100	Not recommended	Not recommended	0.007 to 7.4	0.017 to 17	0.037 to 37	0.063 to 63		
<a href="#">HL-07519-06</a>	4	4 large or 8 small	1:1	6 to 600	Not recommended	Not recommended	0.44 to 44	1.0 to 100	2.2 to 220	3.8 to 380		
				0.1 to 100	Not recommended	Not recommended	0.007 to 7.4	0.017 to 17	0.037 to 37	0.063 to 63		
<b>Using Masterflex precision pump tubing</b>							L/S 13	L/S 14	L/S 16	L/S 25	L/S 17 <sup>††</sup>	—
<a href="#">HL-07519-05</a>	3	4 large or 8 small	1:1	6 to 600	0.30 to 30	1.3 to 130 <sup>†††</sup>	4.6 to 460	10 to 1000	17 to 1700	—		
				0.1 to 100	0.005 to 5	0.021 to 21	0.076 to 76	0.17 to 170	0.28 to 280	—		
<a href="#">HL-07519-06</a>	4	4 large or 8 small	1:1	6 to 600	0.28 to 28	1.2 to 120	3.8 to 380	8.3 to 830	14 to 1400	—		
				0.1 to 100	0.005 to 4.7	0.020 to 20	0.063 to 63	0.14 to 140	0.23 to 230	—		

<sup>††</sup>Only C-FLEX and silicone formulations are recommended for L/S 17.

<sup>†††</sup>Tygon® E-Food and Viton (L/S sizes) are not recommended for multichannel cartridge pump heads.

<sup>††††</sup>Use a maximum of six 07519-70 cartridges when using L/S 14 Norprene®, PharMed® BPT, or Tygon tubing formulations at higher speeds with pump head 07519-05.



## SPECIFICATIONS for L/S Multichannel Cartridge Pump Heads

Catalog number	<a href="#">HL-07519-05</a>	<a href="#">HL-07519-06</a>
<b>Performance Specifications</b>		
Flow capacity per channel	0.005 to 1700 mL/min (0 to 27 GPH)***	
Max rpm	600	
Number of rollers	3	4
Maximum vacuum/suction lift	660 mm Hg (26" Hg)/8.8 m H <sub>2</sub> O (29 ft H <sub>2</sub> O)	
Torque data	Please see pages 172–192	
<b>Physical Specifications</b>		
Housing/Rotor material	Stainless steel/anodized aluminum	Stainless steel
Operating temperature	0 to 40°C (32 to 104°F)	
Shipping weight	1.5 kg (3.3 lb)	

\*\*\*Depending on drive, pump head, and tubing size selected.

## MULTICHANNEL CAPABILITIES

- Mount one pump head with up to eight cartridges on a single drive
- No tools required to insert, remove, or adjust the cartridges
- Change tubing without disturbing other cartridges—eliminates lost time

**Mounting hardware and tool supplied with pump head.**



## MORE INFO

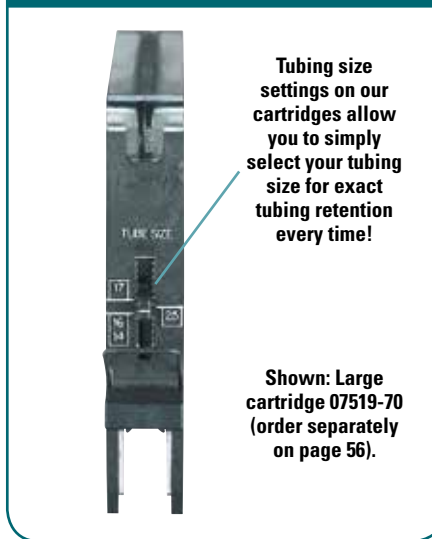

## ORDERING INFORMATION

### Microbore Two-Stop Pump Tubing Sets (for 07519-80 small cartridge)

Tubing ID (mm)	Platinum-cured silicone	Santoprene	Tygon® E-LFL	Viton®
0.89	<a href="#">HL-06421-26</a>	<a href="#">HL-06431-26</a>	<a href="#">HL-06447-26</a>	<a href="#">HL-96428-26</a>
1.42	<a href="#">HL-06421-34</a>	<a href="#">HL-06431-34</a>	<a href="#">HL-06447-34</a>	<a href="#">HL-96428-34</a>
2.06	<a href="#">HL-06421-42</a>	<a href="#">HL-06431-42</a>	<a href="#">HL-06447-42</a>	<a href="#">HL-96428-42</a>
2.79	<a href="#">HL-06421-48</a>	<a href="#">HL-06431-48</a>	<a href="#">HL-06447-48</a>	<a href="#">HL-96428-48</a>
Qty/pk	6	12	12	12

## HOW TO LOAD YOUR PUMP HEAD



**1. Select tubing, load tubing into cartridge, and set tubing retainers.**



**2. Snap cartridge into place on pump head.**



**3. Adjust occlusion using index scale on cartridge.**

## Dimensional Drawings cm (in.) 07519-05, -06 Pump Heads

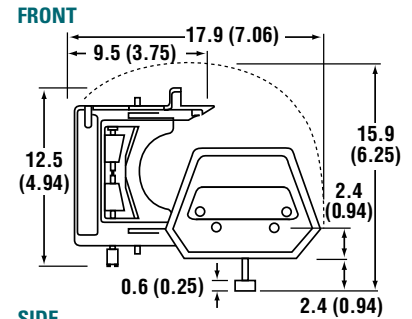

## 07519-70, -80 Cartridges

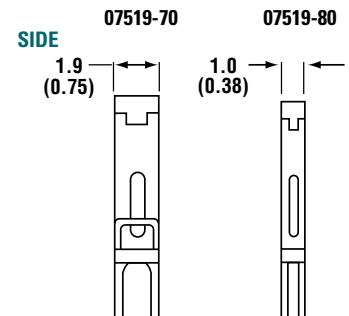
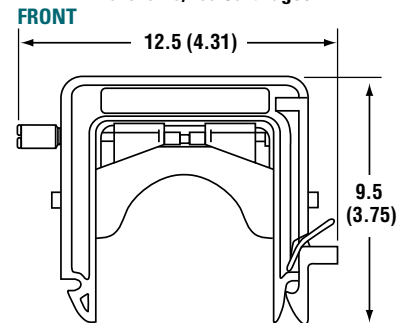

L/S® TUBING .....	68–73
L/S® DRIVES .....	74–107
L/S® PUMP SYSTEMS .....	108–117

ACCESSORIES..... 160–171

TECHNICAL DATA..... 172–206

## L/S® REDUCED-PULSATION CARTRIDGE PUMP HEADS

### FEATURES/BENEFITS

- ▶ Synchronous multichannel pumping
- ▶ Deliver flow rates from 0.00005 to 350 mL/min per channel (flow rates depend on drive rpm and tubing size)
- ▶ Use up to 6 large cartridges or up to 12 small cartridges
- ▶ Use just one cartridge or fill the pump head
- ▶ Adapts easily to OEM applications

### SELECTION CRITERIA

1. Pump head compatibility.
  2. Flow rate and tubing size.
- See specifications for more information.  
**Order tubing and drives separately.**

### COMPATIBILITY WITH DRIVES

- ▶ Mount on most Masterflex L/S drives
- ▶ See specific drive pages for more information.

### PUMP HOUSING SPECIFICATIONS

**Molded Polysulfone Housing**  
**300-Series Stainless Steel (SS) Rotors and Bearings**  
**Rulon® Rollers**

- ▶ Adjustable foot on long heads for support
- ▶ See specifications for maximum drive rpm.

### CARTRIDGE SPECIFICATIONS

**Polycarbonate and Glass-Filled Nylon**

- ▶ No tools required/mechanically stable
- ▶ Anodized aluminum occlusion knob

**Offset Tangential Occlusion**

- ▶ Better flow performance
- ▶ Fine tune flow rate ±5%
- ▶ Flow characteristics virtually the same in each direction of rotation (see note on facing page regarding reduced-pulsation setup)
- ▶ Increase occlusion for priming/greater pressure
- ▶ Decrease occlusion to extend tubing life
- ▶ Index scale on cartridge
- ▶ Use microbore and Masterflex L/S Precision pump tubing sizes

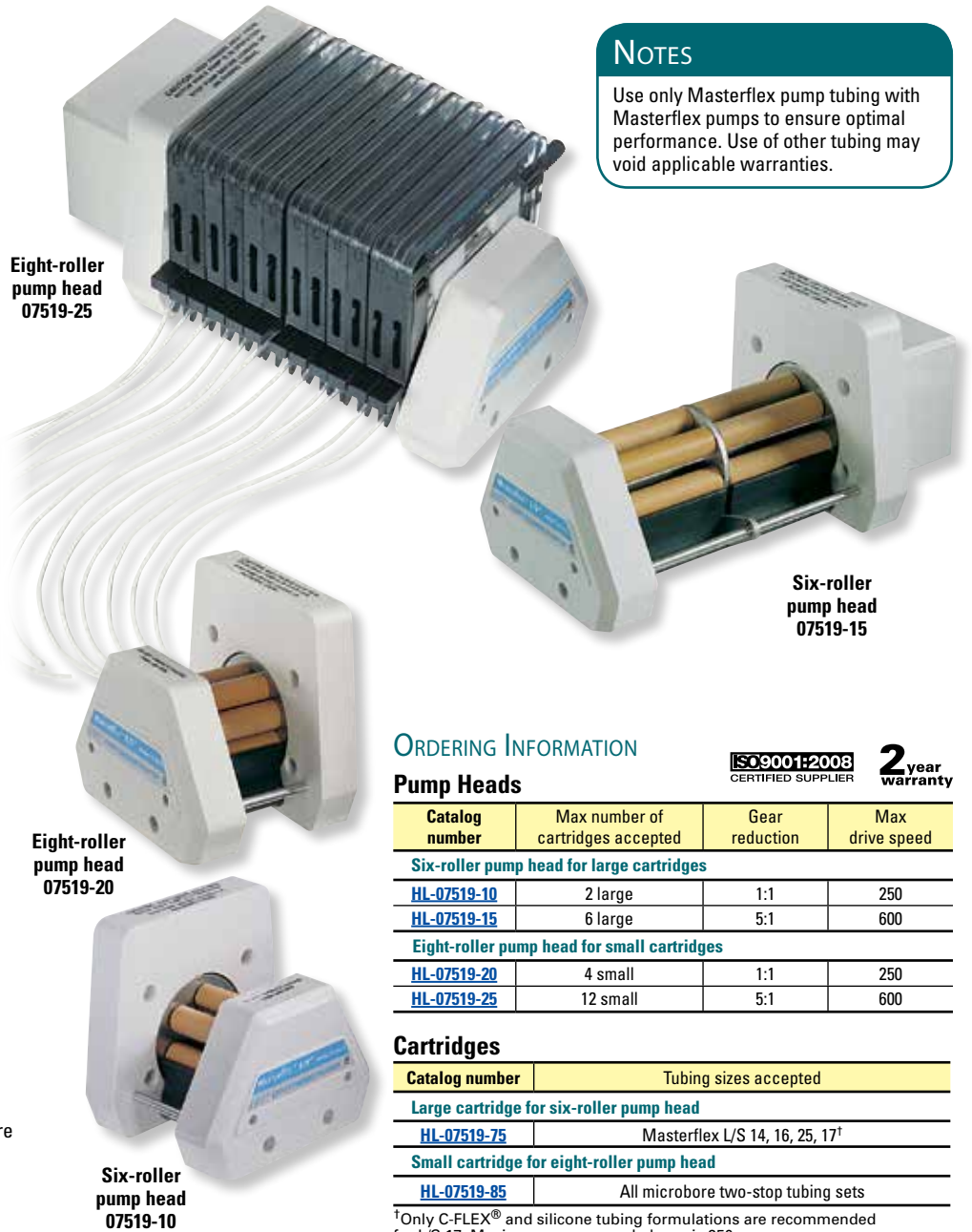

**NOTES**  
 Use only Masterflex pump tubing with Masterflex pumps to ensure optimal performance. Use of other tubing may void applicable warranties.

### ORDERING INFORMATION

ISO 9001:2008  
 CERTIFIED SUPPLIER **2** year warranty

#### Pump Heads

Catalog number	Max number of cartridges accepted	Gear reduction	Max drive speed
<b>Six-roller pump head for large cartridges</b>			
<a href="#">HL-07519-10</a>	2 large	1:1	250
<a href="#">HL-07519-15</a>	6 large	5:1	600
<b>Eight-roller pump head for small cartridges</b>			
<a href="#">HL-07519-20</a>	4 small	1:1	250
<a href="#">HL-07519-25</a>	12 small	5:1	600

#### Cartridges

Catalog number	Tubing sizes accepted
<b>Large cartridge for six-roller pump head</b>	
<a href="#">HL-07519-75</a>	Masterflex L/S 14, 16, 25, 17†
<b>Small cartridge for eight-roller pump head</b>	
<a href="#">HL-07519-85</a>	All microbore two-stop tubing sets

†Only C-FLEX® and silicone tubing formulations are recommended for L/S 17. Maximum recommended rpm is 250.

### SPECIFICATIONS & FLOW RATE INFORMATION (mL/MIN PER CHANNEL)

Pump head model	No. of rollers	Maximum no. of cartridges accepted <sup>‡</sup>	Gear ratio	Drive rpm	Pump tubing sizes (Order microbore two-stop tubing sets on page 57 and Masterflex pump tubing on pages 68–73††.)					
					0.19 mm ID	0.25 mm ID	0.89 mm ID	1.42 mm ID	2.06 mm ID	2.79 mm ID
<b>Using microbore two-stop tubing sets</b>										
<a href="#">HL-07519-20</a>	8	4 small	1:1	6 to 250	0.017 to 0.70	0.31 to 1.3	0.31 to 13	0.70 to 29	1.3 to 54	2.0 to 85
				0.1 to 100	0.003 to 0.28	0.0005 to 0.52	0.005 to 5.2	0.012 to 12	0.022 to 22	0.034 to 34
<a href="#">HL-07519-25</a>	8	12 small	5:1	6 to 600	0.0030 to 0.30	0.060 to 0.60	0.062 to 6.2	0.14 to 14	0.26 to 26	0.41 to 41
				0.1 to 100	0.00005 to 0.050	0.0001 to 0.10	0.001 to 1.0	0.002 to 2.3	0.004 to 4.3	0.007 to 6.8
<b>Using Masterflex Precision pump tubing</b>										
<a href="#">HL-07519-10</a>	6	2 large	1:1	6 to 250	—	0.94 to 39	3.1 to 130	5.8 to 240	8.4 to 350	—
				0.1 to 100	—	0.016 to 16	0.052 to 52	0.096 to 96	0.14 to 140	—
<a href="#">HL-07519-15</a>	6	6 large	5:1	6 to 600	—	0.20 to 20	0.65 to 65	1.2 to 120	1.7 to 170	—
				0.1 to 100	—	0.003 to 3.3	0.011 to 11	0.020 to 20	0.028 to 28	—

<sup>‡</sup>Check pump head torque requirement with drive torque to determine actual number of cartridges.

††Tygon® Food and Viton® (L/S sizes) are not recommended for these reduced-pulsation cartridge pump heads.

\*\*Only C-FLEX® or silicone tubing is recommended for size L/S 17.



## SPECIFICATIONS for L/S Reduced-Pulsation Cartridge Pump Heads

Catalog number	HL-07519-10	HL-07519-15	HL-07519-20	HL-07519-25
<b>Performance Specifications</b>				
Flow capacity per channel	0.00005 to 350 mL/min (0 to 5.5 GPH) <sup>†</sup>			
Max drive rpm	250 <sup>†</sup>	600 <sup>†</sup>	250 <sup>†</sup>	600 <sup>†</sup>
Number of rollers	6		8	
Torque data	Please see page 172–192			
<b>Physical Specifications</b>				
Housing material	Polysulfone ends			
Rotor/roller material	Stainless steel/Rulon®			
Operating temperature	0 to 40°C (32 to 104°F)			
Shipping weight	2.1 kg (4.5 lb)			

<sup>†</sup>Depending on drive, pump head, and tubing size selected.

## REDUCED-PULSATION SETUP

Mount cartridges in opposite directions to use offset occlusion for reduced pulsation.

Connect two discharge tubes together with a Y-connector. This will balance the offset occlusion of each cartridge. The reduced pulsation is measured at the outlet (shown below).



## MULTICHANNEL CAPABILITIES

- Mount one pump head with up to 12 cartridges on a single drive with synchronized or offset occlusion for reduced pulsation
- No tools required to insert, remove, or adjust the cartridges
- Change tubing without disturbing other cartridges—eliminates lost time on other channels
- Best performance with 100 rpm, 1/10 hp motors. Can be used with other drives with a reduced number of cartridges



Mounting hardware and tool supplied with pump head

## FRONT 07519-75, -85 Cartridges

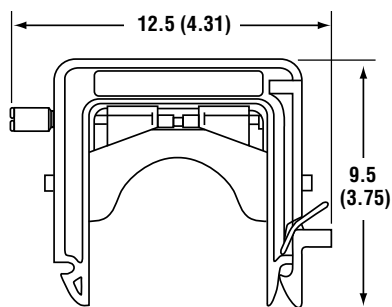

## SIDE 07519-75 07519-85

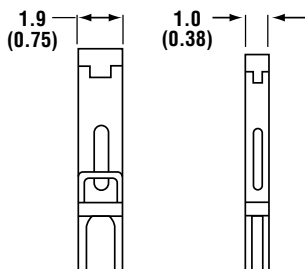

## Dimensional Drawings cm (in.)

### 07519-10, -20 Pump Heads

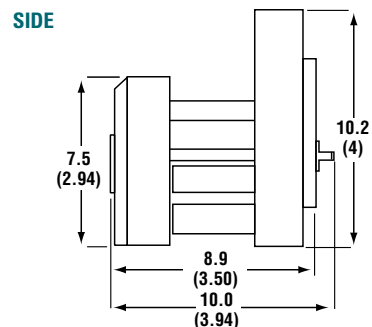

## BACK

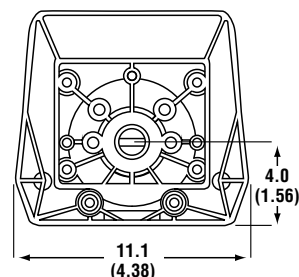

### 07519-15, -25 Pump Heads

## SIDE

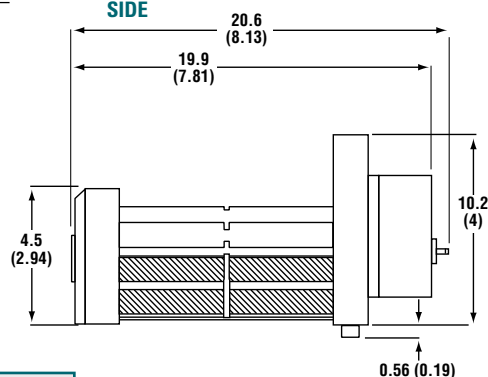

## BACK

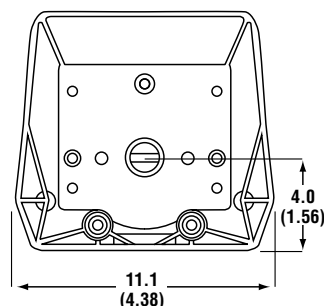

## HOW TO LOAD YOUR PUMP HEAD



1. Select tubing, load cartridge, and set tubing retainers.



2. Easily snap cartridge into place on pump head.



3. Adjust occlusion using index scale on cartridge.

L/S<sup>†</sup> TUBING ..... 68–73  
 L/S<sup>†</sup> DRIVES ..... 74–107  
 L/S<sup>†</sup> PUMP SYSTEMS ..... 108–117

ACCESSORIES ..... 160–171

TECHNICAL DATA ..... 172–206

## L/S® PTFE-DIAPHRAGM PUMP HEADS

### FEATURES/BENEFITS

- ▶ Designed for demanding chemical feed/metering applications
- ▶ Deliver flow rates from 10 to 800 mL/min
- ▶ Run dry without damage
- ▶ Maintain ±2% repeatability across varying system pressures and fluid viscosities
- ▶ Self-priming under wet and dry conditions
- ▶ Compact design minimizes fluid churning and dead volume
- ▶ Handles wide variety of fluids at temperatures up to 66°C (150°F)
- ▶ Pump through filter or into pressurized chamber
- ▶ Easy to clean, inspect, and service
- ▶ Adapts easily to OEM applications

### SELECTION CRITERIA

1. Flow rate/pressure required.
2. Materials of construction.
3. Compatibility with drives.

Tang adapters and mounting hardware are supplied with each head.

See specifications for more information.

**Order fittings and drives separately.**

### COMPATIBILITY WITH DRIVES

- ▶ Mount on most Masterflex L/S drives that accept two or more pump heads
- ▶ Drive requirements: minimum 1/10 hp

**PTFE-diaphragm pump heads include check valves.**



**PTFE-diaphragm pump head 07090-42**

### PUMP HEAD MATERIALS

- ▶ PTFE diaphragm and pump body
- ▶ PTFE valve seat and springs
- ▶ PTFE or borosilicate glass ball checks
- ▶ Cast aluminum housing
- ▶ Tang adapters provide positive connection of pump head to drive for better torque control and quieter operation
- ▶ To determine chemical compatibility of your fluids, see pages 198–206

**ISO9001:2008**  
CERTIFIED SUPPLIER

**2** year  
warranty

### ORDERING INFORMATION

Catalog number	Flow capacity
<a href="#">HL-07090-42</a>	80 to 800 mL/min (1.3 to 13 GPH)
<a href="#">HL-07090-62</a>	10 to 100 mL/min (0.16 to 1.6 GPH)

### COMPLETE L/S® PTFE-DIAPHRAGM PUMP SYSTEM

#### Applications

- ▶ Chemical feed and metering ▶ Chemical injection ▶ High-purity fluid transfer
- ▶ Pumping aggressive chemicals ▶ High-pressure pumping

#### Benefits

- ▶ Continuous pressure up to 50 psi
- ▶ Excellent chemical compatibility ▶ High metering accuracy
- ▶ Self-priming ▶ PTFE fluid path maintains fluid purity

#### Features

- ▶ 1/10-hp, 6 to 600 rpm continuous-duty drive ▶ ±0.25% speed control accuracy
- ▶ ABS plastic housing ▶ DB9 female connection on back for remote control



**77915-10**

### SPECIFICATIONS & ORDERING INFORMATION

Catalog number	Flow range (mL/min)	Pump head included	Tubing included <sup>†</sup>	Tubing sizes accepted	Drive included	Drive speed range (rpm)	Drive IP rating	Power (50/60 Hz)
<a href="#">HL-77915-10</a>	80 to 800	L/S PTFE diaphragm 07090-42	1/4" ID x 3/8" OD PTFE tubing 06605-15; 3.6 m (12 ft)	—	07528-10	40 to 400 <sup>‡</sup>	IP33	90 to 260 VAC

<sup>†</sup>Also includes pipe adapters and check valve. <sup>‡</sup>Recommended drive speed operating range for included pump head.





## SPECIFICATIONS for L/S PTFE-Diaphragm Pump Heads

Catalog number	<a href="#">HL-07090-42</a>	<a href="#">HL-07090-62</a>
<b>Performance Specifications</b>		
Flow capacity	80 to 800 mL/min (1.3 to 13 GPH)	10 to 100 mL/min (0.16 to 1.6 GPH)
Max rpm	400	400
Max pressure	3.4 bar (50 psi) <sup>†</sup>	5.0 bar (75 psi) <sup>†</sup>
Max suction lift (of H <sub>2</sub> O)	61 cm (24") dry, 4.9 m (16 ft) wet	25.4 cm (10") dry, 3 m (10 ft) wet
Max dead volume	16 mL	2 mL
Intake/discharge ports	¼" NPT(M)	⅜" NPT(M)
Max fluid temperature	65°C (149°F)	
Liquid viscosity range	1 to 500 cp (6 to 2900 SSU)	
Reversible	Yes (does not affect flow direction)	
Self-priming, wet or dry	Yes	
Cracking pressure	68 m bar (<1 psi)	
Run dry	Yes	
<b>Torque Specifications [pumping water at 0 psi, 21°C (70°F)]</b>		
Starting torque	5.8 kg-cm (80 oz-in)	3.6 kg-cm (50 oz-in)
Running torque	1.6 kg-cm (22 oz-in)	1.3 kg-cm (18 oz-in)
<b>Physical Specifications</b>		
Housing, diaphragm, spring, and valve seat material	PTFE	
Ball check material	PTFE	Borosilicate glass
Operating temperature	0 to 40°C (32 to 104°F)	
Shipping weight	1.5 kg (4 lb)	1.4 kg (3 lb)

<sup>†</sup>Use a pressure relief valve to prevent higher pressures.

## ACCESSORIES

### For high-flow pump head (07090-42)

[HL-31320-54](#) Female pipe adapter with ¼" NPT(F). Use with ⅜" OD tubing.

[HL-06605-35](#) PTFE tubing, ⅜" OD x ¼" ID. Pack of 7.6 m (25 ft).

[HL-07090-45](#) External check valve with PTFE ball. Inlet and discharge ports are ¼" NPT(M).

[HL-07090-43](#) Service kit. Contains one PTFE diaphragm, two PTFE check valve assemblies, two drive-tang boots, installation wrench.

### For low-flow pump head (07090-62)

[HL-31320-52](#) Female pipe adapter with ⅜" NPT(F). Use with ¼" OD tubing.

[HL-06605-31](#) PTFE tubing, ¼" OD x ⅜" ID. Pack of 7.6 m (25 ft).

[HL-07090-65](#) External check valve with borosilicate glass ball. Inlet and discharge ports are ⅜" NPT(M).

[HL-07090-63](#) Service kit. Contains one PTFE diaphragm, two PTFE check valve assemblies, two drive-tang boots, installation wrench.

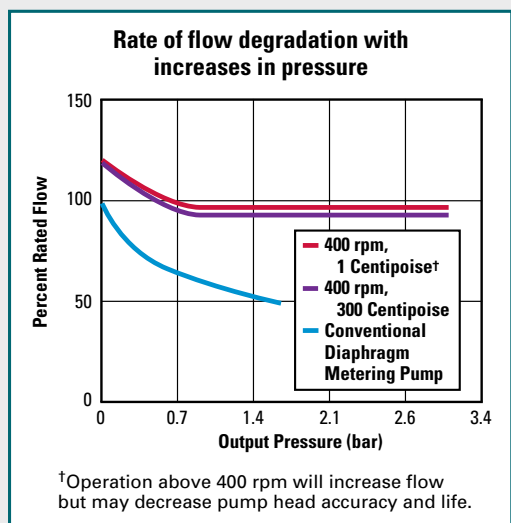

Service kit 07090-63 for PTFE-diaphragm pump head 07090-62

## Dimensional Drawings cm (in.) PTFE-Diaphragm Pump Head

### SIDE

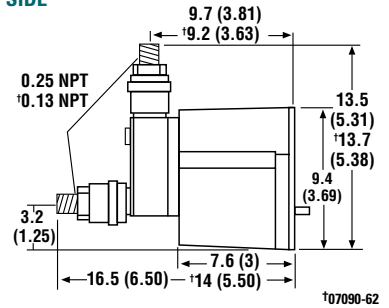

### BACK

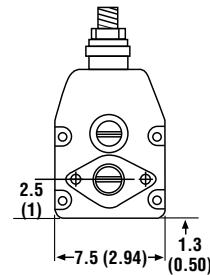

## Pump Head Operation:

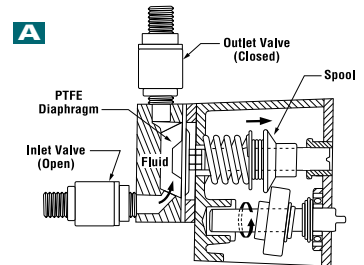

Drive coupling converts rotary to reciprocating motion. On the intake stroke, the PTFE diaphragm is fully retracted, creating a vacuum to open the inlet valve and draw in fluid.

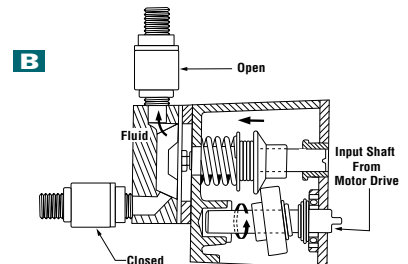

On the discharge stroke, the PTFE diaphragm is driven forward, forcing fluid out through the outlet valve.

L/S TUBING ..... 68-73  
 L/S DRIVES ..... 74-107  
 L/S PUMP SYSTEMS ..... 108-117

ACCESSORIES ..... 160-171

TECHNICAL DATA ..... 172-206

## MICROPUMP A-MOUNT GEAR PUMP HEADS

### FEATURES/BENEFITS

- ▶ Leak-free delivery of fluids
- ▶ Magnetic drive and single seal keep potential contaminants out
- ▶ Precision-geared pump heads provide smooth, accurate, pulseless fluid delivery
- ▶ Wide range of wetted parts handles a variety of challenging chemicals
- ▶ Compact and easy to service with available service kits and simple hand tools
- ▶ Cavity-style pump heads provide high inlet pressures
- ▶ Suction shoe heads provide higher delivery pressures and superior priming performance
- ▶ Continuous-duty cycle

### SELECTION CRITERIA

1. Flow rate and tubing size desired.
2. Compatibility with drives.
3. Mounting adapter plate for Masterflex® L/S® drives.

See specifications for more information.

**Order pump heads and drives separately.**

### COMPATIBILITY WITH DRIVES

- ▶ Mount on all Masterflex L/S drives using the Micropump pump head adapter for 600-rpm Masterflex L/S drives or mount to one of the Micropump-compatible drives on pages 63–64

**HL-07002-15** Micropump pump head adapter kit for 600-rpm Masterflex L/S drives

### PUMP HOUSING SPECIFICATIONS

- ▶ 316 stainless steel base material
- ▶ Gears can be constructed of carbon graphite, PTFE, PPS, or PEEK
- ▶ Static seal materials include Viton®, PTFE, Kalrez, and EPDM (some are standard while others may be requested when ordering, see specifications table for standard materials)



**A** Cavity style design has ability to do reversible flows on models without an internal bypass.



**B** Suction shoe design provides constant flow even when pressure changes

**SEE PAGES 63 AND 64**

To select compatible drives.

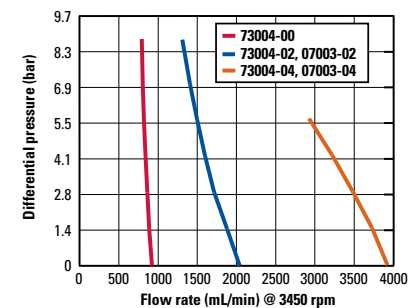
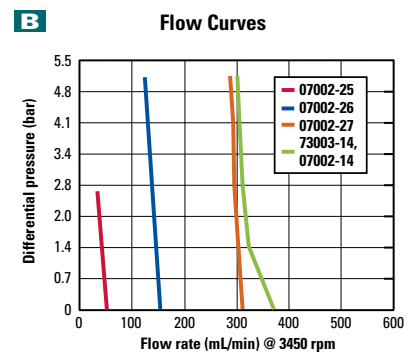
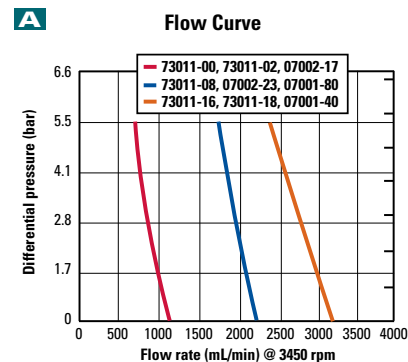

### SPECIFICATIONS & ORDERING INFORMATION

**Max viscosity:** 0.2 to 1500 cp

**Suction lift:** 59.8 millibar (24" of H<sub>2</sub>O at 1750 rpm)

Catalog number	Flow rates (mL/min)			Max pressure (bar)		Port size NPT(F)	Wetted parts			Temperature range	Internal bypass	Max speed (rpm)	Service kits Cat. no.	
	mL/rev	at 50 rpm	at 5000 rpm	Diff	System		Body	Gears	Seals					
<b>A Cavity-style pump heads</b>														
HL-73011-00	0.32	16	1600	5.51	20.68	1/8"	316 SS	PEEK	PTFE	-43 to 54°C	No	10,000	HL-73011-80	
HL-73011-02				5.51				Graphite						HL-73011-80
HL-07002-17				3.44				PTFE						HL-07144-38
HL-07002-23	0.64	32	3200	3.44	20.68	1/8"	316 SS	PTFE	PTFE	-45 to 54°C	Yes	10,000	HL-07002-08	
HL-07001-80				5.17				PPS						HL-07001-89
HL-73011-08	0.64	32	3200	5.51	20.68	1/8"	316 SS	PEEK	PTFE	-43 to 54°C	No	10,000	HL-73011-84	
HL-73011-10				5.51				Graphite						HL-73011-84
HL-73011-16	0.91	45.5	4550	5.51	20.68	1/8"	316 SS	PEEK	PTFE	-43 to 54°C	No	10,000	HL-73011-88	
HL-73011-18				5.51				Graphite						HL-73011-88
HL-07001-40				3.44				PTFE						HL-07001-41
<b>B Suction shoe pump heads</b>														
HL-07002-25	0.017	0.85	85	1.37	20.68	1/8"	316 SS	Graphite	PTFE	-45 to 176°C	No	8000	HL-07144-42	
HL-07002-26	0.042	2.10	210	2.75	20.68	1/8"	316 SS	Graphite	PTFE	-45 to 176°C	No	8000	HL-07144-44	
HL-07002-27	0.084	4.20	420	2.75	20.68	1/8"	316 SS	Graphite	PTFE	-45 to 176°C	No	8000	HL-07144-47	
HL-73003-14	0.092	4.60	460	5.17	20.68	1/8"	316 SS	PEEK	PTFE	-45 to 176°C	No	8000	HL-73003-94	
HL-07002-14				20.68	PPS	HL-07144-34								
HL-73004-00	0.261	13.05	1305	8.61	20.68	1/8"	316 SS	PEEK	Viton	-45 to 176°C	Yes	10,000	HL-73004-80	
HL-73004-02	0.58	29.00	2900	8.61	20.68	1/8"	316 SS	PEEK	Viton	-45 to 176°C	Yes	10,000	HL-73004-82	
HL-07003-02				5.17				PPS						HL-07003-12
HL-73004-04				5.17				PEEK						HL-73004-84
HL-07003-04	1.17	58.50	5850	4.13	20.68	1/8"	316 SS	PPS	Viton	-45 to 176°C	Yes	10,000	HL-07003-14	

Note: Viscosity for all models is dependent on the parameters (flow rate, pressure, etc.) of the specific applications. Flow rates based on water at room temperature and no back pressure.





## MICROPUMP®-COMPATIBLE DRIVES

### FEATURES/BENEFITS

- ▶ Console or wall-mount washdown models
- ▶ Easily operate console from front panel or use optional foot switch for hands-free operation
- ▶ Wall-mount washdown drive is ideal for your industrial or dirty locations; the IP56-rated enclosure is connected to motor via 7.6-m (25-ft) cable
- ▶ Calibrate, copy, and dispense features
- ▶ Precise, pulseless batching and dispensing
- ▶ Calibration values for all Micropump® A-mount pump heads are stored in memory
- ▶ Front-panel pump head calibration
- ▶ Digital optical encoder feedback signal keeps speed control to ±0.3%
- ▶ Remote control capabilities
- ▶ Keypad lockout feature



Console digital dispensing drive  
75211-30



Wall-mount digital dispensing drive  
75211-40

### SELECTION CRITERIA

1. Console or wall-mount version.
2. Voltage required.

See specifications for more information.

**Order pump heads and drives separately.**

### DRIVE CONTROLS

- ▶ Controls on front panel of drive controller
- ▶ Lighted display indicates power is on
- ▶ Simple, push-button programming of the following parameters:
  - ◆ Pump SIZE           ◆ MODE
  - ◆ DISPense           ◆ CALibration
  - ◆ FLOW rate           ◆ PRIME
  - ◆ Up/Down (▲▼)   ◆ Stop/Start

**Note:** Up/Down keys are used to change the display value of flow rate and calibration functions during setup or operation.

### PUMP HEAD COMPATIBILITY

- ▶ Use with Micropump A-mount pump heads on page 62

### NOTES

To calibrate digital dispensing drives for fluids other than water, enter the actual volume of fluid dispensed during a timed run.



### ORDERING INFORMATION

Catalog number	Power (50/60 Hz)
<b>Console digital dispensing drive</b>	
HL-75211-30	115 VAC
HL-75211-35	230 VAC
<b>Wall-mount washdown digital dispensing drive</b>	
HL-75211-40	115 VAC
HL-75211-45	230 VAC

### ACCESSORIES

**HL-07595-42 Foot switch** for remote start/stop control of 75211-30 and -35 drives.

**HL-07592-83 Handheld remote controller** for use with 75211-40 and -45 drives. Features start/stop, reverse, and momentary on (prime) functions.

### SPECIFICATIONS for Micropump-Compatible Drives

Catalog number	HL-75211-30	HL-75211-35	HL-75211-40	HL-75211-45
<b>Performance Specifications</b>				
Flow capacity	3.06 to 4212 mL/min (0.048 to 67 GPH) <sup>†</sup>		1.02 to 4212 mL/min (0.016 to 67 GPH) <sup>†</sup>	
rpm	180 to 3600		60 to 3600	
Remote control – Input	ON/OFF by contact closure; 0 to 20 mA, 4 to 20 mA, 0 to 10 VDC			
<b>Physical Specifications</b>				
Voltage/Frequency VAC (50/60 Hz)	90 to 130	190 to 260	90 to 130	190 to 260
Current	3 A	1.5 A	3 A	1.5 A
Motor type	1/10-hp, permanent-magnet DC			
IP rating <sup>‡</sup>	IP23		IP56 (NEMA 4X)	
Operating temperature	0 to 40°C (32 to 104°F)			
Dimensions (L x W x H)	Console	29.2 x 19.7 x 18.4 cm (11½" x 7¾" x 7¼")		
	Wall-mount	Controller: 11.4 x 27.9 x 22.9 cm (11½" x 7¾" x 7¼") Drive: 20.3 x 10.2 x 11.4 cm (8" x 4" x 4½")		
Shipping weight	6.4 kg (14 lb)		9.1 kg (20 lb)	

<sup>†</sup>Depending on pump head selected.

<sup>‡</sup>See page 194 for an explanation of IP ratings.

## Cole-Parmer® CONSOLE DRIVE

### FEATURES/BENEFITS

- ▶ Permanent-magnet, direct-current (PMDC) motor is built for long-term applications
- ▶ Maximum continuous-duty flow rates possible with Micropump® A-mount pump heads on page 62
- ▶ Gradual, one-second acceleration for smooth flow rate changes

### SELECTION CRITERIA

1. Voltage required.

See specifications for more information.

**Order pump heads and drives separately.**

### DRIVE CONTROLS

- ▶ Single-turn potentiometer speed control
- ▶ Separate power switch with lighted "power-on" indicator

### PUMP HEAD COMPATIBILITY

- ▶ Use with Micropump A-mount pump heads on page 62



75211-10

### SPECIFICATIONS & ORDERING INFORMATION

ISO9001:2008 CERTIFIED SUPPLIER cULus CE 2 year warranty

Catalog number	HL-75211-10	HL-75211-15
<b>Performance Specifications</b>		
Flow capacity	0.85 to 5850 mL/min (0.013 to 92.7 GPH)	
rpm	50 to 5000	
Remote control – Input	No	
<b>Physical specifications</b>		
Voltage/Frequency VAC (50/60 Hz)	115	230
Current	2.0	1.0
Motor type	Permanent magnet DC	
IP rating <sup>†</sup>	IP22	
Operating temperature	0 to 40°C (32 to 104°F)	
Dimensions	21.6 x 16.2 x 13.2 cm (8½" x 6⅜" x 5⅝")	
Shipping weight	5.0 kg (11 lb)	

<sup>†</sup>See page 194 for an explanation of IP ratings.

## Cole-Parmer® MODULAR GEAR PUMP DRIVE

### FEATURES/BENEFITS

- ▶ Permanent-magnet, direct-current (PMDC) motor is built for long-term applications
- ▶ "Soft-start" feature allows gradual, one-second acceleration for smooth flow rate change
- ▶ Continuous-duty drives feature 2% line/load regulation
- ▶ Controller features IP23-rated housing and single-turn potentiometer for speed control
- ▶ IP21-rated motor features a welded base for mounting or for free-standing use. Compatible with all Micropump® A-mount pump heads on page 62.



75211-20

### SELECTION CRITERIA

1. Voltage required.

See specifications for more information.

**Order pump heads and drives separately.**

### DRIVE CONTROLS

- ▶ Controls on front panel of drive controller
- ▶ Single-turn potentiometer speed control
- ▶ Separate power switch with lighted "power-on" indicator

### PUMP HEAD COMPATIBILITY

- ▶ Use with Micropump A-mount pump heads on page 62

### SPECIFICATIONS & ORDERING INFORMATION

ISO9001:2008 CERTIFIED SUPPLIER cULus CE 2 year warranty

Catalog number	HL-75211-20	HL-75211-25
<b>Performance Specifications</b>		
Flow capacity	0.68 to 4212 mL/min (0.01 to 66.6 GPH)	
rpm	40 to 3600	
Remote control – Input	No	
<b>Physical specifications</b>		
Voltage/Frequency VAC (50/60 Hz)	115	230
Current	2.3	1.2
Motor type	Permanent magnet DC	
IP rating <sup>†</sup>	IP21	
Operating temperature	0 to 40°C (32 to 104°F)	
Dimensions	Controller: 17.3 x 8.3 x 13.4 cm (7" x 3¼" x 5¼") Drive: 17.3 x 12.3 x 9.2 cm (6⅞" x 4⅞" x 3⅝")	
Shipping weight	5.9 kg (13 lb)	

<sup>†</sup>See page 194 for an explanation of IP ratings.



## Cole-Parmer® GEAR PUMP SYSTEMS

### FEATURES/BENEFITS

- Complete pump system—drive and pump head—with a single catalog number

### BENCHTOP ANALOG PUMPS

- Gradual on-second acceleration offers smooth control of drive speed and flow rate
- PMD drive is built to last—excellent for long-term applications
- System includes analog console drive 75211-10 (115 V) or 75211-15 (230 V); see page 64 for drive specifications

### BENCHTOP DIGITAL PUMPS

- Calibrate, copy, and dispense features produce precise, pulseless batching and dispensing
- Displacements and flow values for all Micropump® A-mount pump heads are stored in memory
- IP23-rated enclosure protects the internal components
- Controller has a DB15F connection to the optional foot switch for hands-free on/off control (order foot switch separately below)
- System includes digital console drive 75211-30 (115 V) or 75211-35 (230 V); see page 63 for drive specifications



Benchtop analog pump system 74013-40



Benchtop digital pump system 74014-30

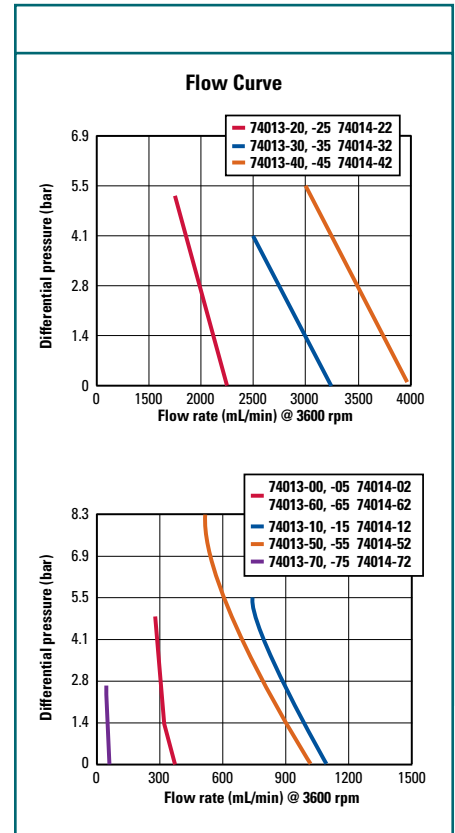

### MORE INFO

**Service kits 07144-42; 74012-02, -42, and -52 include:** gears, suction shoe, shaft seals, and springs.

**Service kits 74012-12, -22, and -32 include:** gears, bushings, and seals.

### SPECIFICATIONS & ORDERING INFORMATION

**Viscosity:** 0.2 to 1500 cp

**Suction lift:** 59.8 millibar (24" of H<sub>2</sub>O) at 1750 rpm

**Duty cycle:** continuous

#### Remote control

74013-00 to -65: none  
74014-00 to -65: (input) on/off by contact closure 0 to 10 VDC, 0 to 20 mA, 4 to 20 mA, and remote output

**Max temperature:** 40°C (104°F)

#### Speed

Analog drives: 50 to 5000 rpm  
Digital drives: 60 to 3600 rpm

**Dimensions (L x W x H)**

**Analog drives:** 21.6 x 16.2 x 13.8 cm (8½" x 6¾" x 5½")

**Digital drives:** 19.7 x 29.2 x 18.4 cm (7¾" x 11½" x 7¼")



Flow rates (mL/min) <sup>†</sup>			Max pressure		Port size NPT(F)	Wetted parts			Temperature range	Power (VAC)	Benchtop analog pumps	Benchtop digital pumps	Service kits
mL/rev	at 50 rpm	at 3600 rpm	Diff (bar)	System (bar)		Body	Gears	Seals			Catalog number	Catalog number	Catalog number
0.017	0.85	85	1.37	20.68	⅛"	316 SS	Graphite	PTFE	-46 to 177°C (-50 to 350°F)	115	<a href="#">HL-74013-70</a>	<a href="#">HL-74014-70</a>	<a href="#">HL-07144-42</a>
										220	<a href="#">HL-74013-75</a>	<a href="#">HL-74014-75</a>	
0.092	4.60	331.2	5.17	20.68	⅛"	316 SS	PPS	PTFE	-46 to 177°C (-50 to 350°F)	115	<a href="#">HL-74013-00</a>	<a href="#">HL-74014-00</a>	<a href="#">HL-74012-02</a>
										220	<a href="#">HL-74013-05</a>	<a href="#">HL-74014-05</a>	
0.092	4.60	331.2	5.17	20.68	⅛"	316 SS	PPS	PPS	-46 to 177°C (-50 to 350°F)	115	<a href="#">HL-74013-60</a>	<a href="#">HL-74014-60</a>	—
										220	<a href="#">HL-74013-65</a>	<a href="#">HL-74014-65</a>	
0.261	13.05	939.6	8.61	20.68	⅛"	316 SS	PEEK	Viton	-46 to 177°C (-50 to 350°F)	115	<a href="#">HL-74013-50</a>	<a href="#">HL-74014-50</a>	<a href="#">HL-74012-52</a>
										220	<a href="#">HL-74013-55</a>	<a href="#">HL-74014-55</a>	
0.316	15.8	1137.6	5.17	20.68	⅛"	316 SS	PPS	PTFE	-46 to 54°C (-50 to 130°F)	115	<a href="#">HL-74013-10</a>	<a href="#">HL-74014-10</a>	<a href="#">HL-74012-12</a>
										220	<a href="#">HL-74013-15</a>	<a href="#">HL-74014-15</a>	
0.64	32.0	2304	5.17	20.68	⅛"	316 SS	PPS	PTFE	-46 to 54°C (-50 to 130°F)	115	<a href="#">HL-74013-20</a>	<a href="#">HL-74014-20</a>	<a href="#">HL-74012-22</a>
										220	<a href="#">HL-74013-25</a>	<a href="#">HL-74014-25</a>	
0.91	45.5	3276	5.17	20.68	⅛"	316 SS	PPS	PTFE	-46 to 54°C (-50 to 130°F)	115	<a href="#">HL-74013-30</a>	<a href="#">HL-74014-30</a>	<a href="#">HL-74012-32</a>
										220	<a href="#">HL-74013-35</a>	<a href="#">HL-74014-35</a>	
1.17	58.5	4212	4.13	20.68	⅛"	316 SS	PPS	Viton®	-46 to 177°C (-50 to 350°F)	115	<a href="#">HL-74013-40</a>	<a href="#">HL-74014-40</a>	<a href="#">HL-74012-42</a>
										220	<a href="#">HL-74013-45</a>	<a href="#">HL-74014-45</a>	

<sup>†</sup>Flow rates in mL/min are based on water at room temperature and no back pressure.

### ACCESSORIES

[HL-07595-42](#) Foot switch, for momentary start/stop control. 6-ft cable.

[HL-06385-10](#) Male pipe adapter (straight); PP, ¼"OD x ⅛" NPT(M). Pack of 10.

[HL-30621-31](#) Male pipe adapter; HDPE, ⅛" NPT(M) x ¼" ID. Pack of 10.

[HL-40610-36](#) Male pipe adapter; natural PP, ⅛" NPT(M) x ¼" ID. Pack of 10.

## ISMATEC® MINICARTRIDGE PUMP HEADS



Ismatec®  
micartridge  
pump head  
07623-00  
shown with  
Masterflex®  
L/S® drive  
07528-10

### SPECIFICATIONS for Ismatec® Micartridge Pump Heads

Catalog number	HL-07623-00	HL-07623-10
<b>Performance Specifications</b>		
Flow capacity	0.003 to 195 mL/min (0 to 3 GPH)	0.002 to 156 mL/min (0 to 2.5 GPH)
Max rpm	600	
Number of rollers	6	8
Number of channels available	Up to 8	
<b>Torque Specifications [single channel pumping water @ 0 psi, 21°C (70°F)]</b>		
PharMed® BPT, Tygon®	Starting torque	0.86 kg-cm (12 oz-in)
	Running torque	0.7 kg-cm (10 oz-in)
Silicone	Starting torque	0.5 kg-cm (7 oz-in)
	Running torque	0.2 kg-cm (3 oz-in)
<b>Physical Specifications</b>		
Housing material	Anodized aluminum	
Rotor material	Nylatron®	
Shipping weight	1.9 kg (2 lb)	

### FEATURES/BENEFITS

- ▶ Deliver flow rates from 0.002 to 195 mL/min
- ▶ Click'n'Go™ micartridges are easy to load and feature spring occlusion
- ▶ Optimum tension; no need for adjustments
- ▶ Accepts three-stop tubing
- ▶ Tubing life is twice as long—when first tubing section fatigues, move to fresh section
- ▶ Adapts easily to OEM applications

### SELECTION CRITERIA

- Flow rate.
  - ◆ 6-roller pump head for higher flow rate
  - ◆ 8-roller pump head for smoother flow
- Number of rollers.
- Compatibility with drives.
- Number of channels per drive rpm.

Order tubing and drive separately.

### COMPATIBILITY WITH DRIVES

- ▶ Mount on all drives accepting Masterflex® L/S® pump heads

### PUMP HEAD SPECIFICATIONS

- ▶ Anodized aluminum frame
- ▶ Nylatron® rollers
- ▶ Nylon micartridges

### PUMP HEAD LOADING

- Thread tubing through cartridge between stops.
- Seat the tubing collar in recessed holder.
- Load cartridge into pump head and adjust occlusion.

### MULTICHANNEL CAPABILITIES

Achieve up to eight channels depending on the drive. Micartridges, mounting hardware, and support foot are included with pump heads.

Masterflex drive models	Recommended no. of channels
HL-07554-80, -85, -90, -95	Up to 200 rpm, 8 Up to 400 rpm, 5 Up to 600 rpm, 3
All other L/S models	Up to 200 rpm, 8 Up to 400 rpm, 7 Up to 600 rpm, 6

ISO9001:2008  
CERTIFIED SUPPLIER

CE 1 year warranty

### ORDERING INFORMATION

Catalog number	No. of rollers	Flow range
HL-07623-00	6	0.003 to 195 mL/min
HL-07623-10	8	0.002 to 156 mL/min

HL-78016-98 Replacement Click'n'Go™ micartridge.

## THREE-STOP TUBING FLOW RATE & ORDERING INFORMATION

Step 1: See table below for catalog number prefix.

Three-stop, color-coded tubing				Extension tubing	
Cat. no. prefix	Type	Suffixes for the available sizes	Tubes/pk (length) <sup>†</sup>	Cat. no. prefix	Length/pk
HL-96450-XX	Tygon® E-LFL	10, 12, 18, 26, 30, 34, 42, 48	12 (16")	HL-06449-XX	100 ft
HL-96458-XX	Tygon® E-Food		12 (16")	HL-06457-XX	100 ft
HL-96461-XX	Tygon® E-Lab		12 (16")	HL-06460-XX	100 ft
HL-07624-XX	Silicone (peroxide-cured)	22, 24, 26, 28, 30, 32, 34, 36, 38, 40, 42, 44, 46, 48	6 (16")	HL-07625-XX	50 ft
HL-95603-XX	Silicone (platinum-cured)	22, 24, 26, 28, 30, 32, 34, 36, 38, 40, 42, 44, 46, 48	6 (16")	HL-95612-XX	50 ft
HL-97629-XX	Viton®	26, 30, 34, 38, 42, 46, 48	12 (12")	HL-97632-XX	50 ft
HL-95714-XX	PharMed® BPT	12, 18, 26, 32, 36, 40, 44, 48	12 (16")	HL-95809-XX	100 ft
HL-95693-XX	Autoclavable PharMed® BPT	12, 32, 48	6 (16")	HL-95809-XX	100 ft
HL-95605-XX	PVC Solvent/Hydrocarbon	10, 12, 14, 18, 22, 24, 26, 28, 30, 32, 34, 36, 40, 42, 44, 46, 48	12 (16")	HL-95712-XX	50 ft
HL-96425-XX	MHLL	24, 30, 36, 42, 48	6 (16")	None (PharMed BPT recommended for extension tubing; see 95809-XX above)	

Step 2: Add on suffix to complete the catalog number.

Catalog number suffix	ID (mm)	Color-coded stops	Flow rates (mL/min) <sup>‡</sup>			
			1 to 100 rpm drives		6 to 600 rpm drives	
			6 rollers	8 rollers	6 rollers	8 rollers
-10	0.19	Orange/red	0.003 to 0.32	0.002 to 0.26	0.030 to 1.2	0.002 to 1.0
-12	0.25	Orange/blue	0.004 to 0.65	0.003 to 0.54	0.007 to 2.7	0.005 to 2.1
-14	0.38	Orange/green	0.008 to 1.1	0.007 to 0.09	0.011 to 4.6	0.009 to 3.6
-16	0.44	Green/yellow	0.012 to 1.6	0.009 to 1.3	0.014 to 5.5	0.011 to 4.4
-18	0.51	Orange/yellow	0.016 to 2.0	0.013 to 1.7	0.017 to 6.9	0.014 to 5.5
-22	0.64	Orange/white	0.025 to 3.1	0.020 to 2.6	0.033 to 20	0.026 to 15
-24	0.76	Black/black	0.030 to 3.9	0.025 to 3.2	0.047 to 28	0.037 to 22
-26	0.89	Orange/orange	0.043 to 5.4	0.036 to 4.5	0.060 to 36	0.048 to 39
-28	1.02	White/white	0.058 to 7.0	0.048 to 5.9	0.082 to 4.9	0.065 to 39
-30	1.14	Red/red	0.072 to 8.6	0.060 to 7.2	0.088 to 53	0.071 to 42
-32	1.30	Gray/gray	0.079 to 10	0.066 to 8.6	0.11 to 67	0.089 to 54
-34	1.42	Yellow/yellow	0.086 to 12	0.072 to 9.9	0.14 to 81	0.11 to 65
-36	1.52	Blue/blue	0.10 to 14	0.084 to 11	0.14 to 85	0.11 to 68
-38	1.65	Blue/blue	0.12 to 15	0.096 to 13	0.17 to 103	0.14 to 82
-40	1.85	Green/green	0.16 to 20	0.13 to 16	0.20 to 121	0.16 to 97
-42	2.06	Purple/purple	0.19 to 23	0.16 to 19	0.23 to 136	0.18 to 109
-44	2.29	Purple/black	0.20 to 24	0.17 to 20	0.24 to 148	0.20 to 118
-46	2.54	Purple/orange	0.23 to 29	0.19 to 24	0.29 to 173	0.23 to 138
-48	2.79	Purple/white	0.26 to 32	0.22 to 27	0.32 to 195	0.26 to 156

<sup>†</sup>Length of assembly may vary by ±1".

<sup>‡</sup>Flow rates (mL/min) are nominal. Actual flow rates will depend on occlusion, fluid viscosity, pressure, etc.



## VALVELESS PISTON PUMP HEADS

### FEATURES/BENEFITS

- ▶ Deliver flow rate from 0.08 to 432 mL/min
- ▶ Ideal for dispensing and metering
- ▶ No valves to clog or wear
- ▶ Sensitive mechanical stroke length adjustment is accurate to within ±1%
- ▶ Maximum viscosity: 500 centipoise
- ▶ Maximum pressure: 6.9 bar (100 psi)
- ▶ Low dead volume; self-priming
- ▶ 3A-approved sanitary models available
- ▶ Build your own pump systems using interchangeable heads, drives, and accessories

### SELECTION CRITERIA

1. Flow rate.
2. Piston diameter.
3. Construction material.

**Order pump head, adapter kit, drive, and tubing separately.**

### COMPATIBILITY WITH DRIVES

- ▶ Mount on Masterflex® L/S® drives using optional Adapter Kit
- ▶ Depending on setup, drive may need to be elevated for proper adapter use.

### PUMP HEAD SPECIFICATIONS

#### Stainless steel (SS) and ceramic models

- ▶ Handle temperatures to 177°C (350°F)
- ▶ Kynar® PVDF cylinder body available



Masterflex® L/S® drive  
07528-10  
(sold separately on  
pages 84–85)

Adapter kit 07104-48  
(required)

Valveless piston  
pump head  
07104-50  
(see specifications and  
order separately below)

### MASTERFLEX® L/S® ADAPTER KIT

This adapter kit is required to convert your L/S drive for use with these valveless piston pump heads. Pump heads have adjustable stroke length to adjust flow rate, allowing you to convert your fixed-speed drive into a variable-flow pump.



Mounting hardware included in the adapter kit.

Catalog number	Description	Includes
<a href="#">HL-07104-48</a>	Masterflex L/S adapter kit	All necessary mounting hardware and fittings

### ORDERING INFORMATION for Valveless Piston Pump Heads

Catalog number	Max flow rate (mL/min) at various rpm (vary flow rate by adjusting rpm or stroke length)		Max bar	Max temperature	Piston diameter	Materials of construction			Shpg wt kg (lb)
	1 to 100 rpm	6 to 600 rpm				Piston	Cylinder body	Cylinder liner	
<b>Standard high-flow pump heads</b>									
<a href="#">HL-07104-50</a>	0.08 to 8.00	0.48 to 48.00	6.8	60°C (140°F)	1/8"	316 SS	316 SS	Carbon	0.6 (1.3)
<a href="#">HL-07104-52</a>			4.1						0.3 (0.7)
<a href="#">HL-07117-26</a>	0.32 to 32.00	1.92 to 192.00	4.1	60°C (140°F)	1/4"	316 SS	Kynar PVDF	Carbon	0.4 (0.8)
<a href="#">HL-07104-62</a>			6.8						0.5 (1.1)
<a href="#">HL-07104-54</a>	0.32 to 32.00	1.92 to 192.00	4.1	100°C (212°F)	1/4"	Ceramic	Kynar PVDF	Ceramic	0.4 (0.8)
<a href="#">HL-07104-58</a>			6.8						0.6 (1.2)
<a href="#">HL-07104-56</a>	0.32 to 32.00	1.92 to 192.00	6.8	177°C (350°F)	1/4"	Ceramic	316 SS	Ceramic	0.6 (1.2)
<a href="#">HL-07104-60</a>			4.1						0.5 (1.1)
<a href="#">HL-07117-28</a>	0.72 to 72.00	4.32 to 432.00	4.1	60°C (140°F)	3/8"	316 SS	Kynar PVDF	Carbon	0.5 (1.1)
<a href="#">HL-07104-72</a>			6.8						0.5 (1.1)
<a href="#">HL-07104-64</a>	0.72 to 72.00	4.32 to 432.00	4.1	100°C (212°F)	3/8"	Ceramic	Kynar PVDF	Ceramic	0.4 (0.8)
<a href="#">HL-07104-68</a>			6.8						0.5 (1.1)
<a href="#">HL-07104-66</a>	0.72 to 72.00	4.32 to 432.00	6.8	177°C (350°F)	3/8"	Ceramic	316 SS	Ceramic	0.5 (1.1)
<a href="#">HL-07104-70</a>			4.1						0.5 (1.1)
<b>Sanitary high-flow pump heads; meet 3A Sanitary Standard Q2-08A1 for use with foods</b>									
<a href="#">HL-07117-20</a>	0.32 to 32.00	1.92 to 192.00	6.8	177°C (350°F)	1/4"	Ceramic	316 SS	Ceramic	0.5 (1.1)
<a href="#">HL-07117-22</a>	0.72 to 72.00	4.32 to 432.00			3/8"				

### ACCESSORIES

#### Kynar® PVDF Tubing Adapters (for 1/4" OD compression fittings)

Cat. no. (each)	Description
<a href="#">HL-07115-81</a>	For 1/8" ID tubing
<a href="#">HL-07115-83</a>	For 1/4" ID tubing
<a href="#">HL-07115-88</a>	For 3/8" ID tubing
<a href="#">HL-07115-89</a>	For 1/4"-28 female thread
<a href="#">HL-07115-97</a>	For 1/8" OD tubing



L/S TUBING ..... 68–73  
L/S DRIVES ..... 74–107  
L/S PUMP SYSTEMS ..... 108–117

ACCESSORIES ..... 160–171

TECHNICAL DATA ..... 172–206







## L/S® PRECISION PUMP TUBING

- Ensure optimal performance from your Masterflex pump
- Custom extruded to fit Masterflex pumps
- Engineered for long life in peristaltic pump applications
- Lot-to-lot consistency provides superior accuracy and repeatability

Masterflex L/S pump tubing is manufactured to extremely close tolerances that match our L/S pump heads, ensuring accurate, repeatable flow and long tubing life. Our pump tubing is factory-tested and optically inspected to provide the best performance from your peristaltic pump. With 21 different materials available, there is an L/S pump tubing formulation suitable for nearly any fluid handling application.

Our High-performance Precision pump tubing features a thicker wall compared to our Precision pump tubing, making it the best choice for applications involving pressure, suction lift, viscous fluids, or long tubing life. See pages 70–71 to order.









### SPECIFICATIONS

Pump tubing cross sections	L/S Precision pump tubing					
						
	L/S 13	L/S 14	L/S 16	L/S 25	L/S 17	L/S 18
Inside diameter (nominal)	0.8 mm (0.03")	1.6 mm (0.06")	3.1 mm (0.12")	4.8 mm (0.19")	6.4 mm (0.25")	7.9 mm (0.31")
Hose barb size	1.6 mm (1/16")	1.6 mm (1/16")	3.2 mm (1/8")	4.8 mm (3/16")	6.4 mm (1/4")	9.5 mm (3/8")
Flow range (approximate) <sup>†</sup> with 1 to 600 rpm drive	0.06 to 36 mL/min	0.21 to 130 mL/min	0.8 to 480 mL/min	1.7 to 1000 mL/min	2.8 to 1700 mL/min	3.8 to 2300 mL/min
Maximum pressure <sup>‡</sup>	2.7 bar (40 psig)			2.4 bar (35 psig)	1.4 bar (20 psig)	1.0 bar (15 psig)
Maximum vacuum <sup>‡</sup>	660 mm Hg (26" Hg)			510 mm Hg (20" Hg)		
Suction lift <sup>‡</sup>	8.8 m H <sub>2</sub> O (29 ft H <sub>2</sub> O)			6.7 m H <sub>2</sub> O (22 ft H <sub>2</sub> O)		

<sup>†</sup>Determined under the following conditions: 0 psi at inlet, 0.5 psi at outlet; water temperature at 22°C (72°F). values shown are for firm tubing. Value for GORE® pump tubing is 4.1 bar (60 psi) continuous.

<sup>‡</sup>Actual performance varies depending on tubing formulation—

### ORDERING INFORMATION

Pump tubing formulation	L/S Pump Head Compatibility					L/S 13	L/S 14	L/S 16	L/S 25	L/S 17	L/S 18
	Standard	Easy-Load®	Easy-Load II	Easy-Load 3	Multichannel Cartridge						
 Silicone (platinum-cured)	✓	✓	✓	✓	✓	<a href="#">HL-96410-13</a> 7.6 m (25 ft)/pk	<a href="#">HL-96410-14</a> 7.6 m (25 ft)/pk	<a href="#">HL-96410-16</a> 7.6 m (25 ft)/pk	<a href="#">HL-96410-25</a> 7.6 m (25 ft)/pk	<a href="#">HL-96410-17</a> 7.6 m (25 ft)/pk	<a href="#">HL-96410-18</a> 7.6 m (25 ft)/pk
 Silicone (peroxide-cured)	✓	✓	✓	✓	✓	<a href="#">HL-96400-13</a> 7.6 m (25 ft)/pk	<a href="#">HL-96400-14</a> 7.6 m (25 ft)/pk	<a href="#">HL-96400-16</a> 7.6 m (25 ft)/pk	<a href="#">HL-96400-25</a> 7.6 m (25 ft)/pk	<a href="#">HL-96400-17</a> 7.6 m (25 ft)/pk	<a href="#">HL-96400-18</a> 7.6 m (25 ft)/pk
 BioPharm silicone (platinum-cured)	✓	✓	✓	✓	✓	<a href="#">HL-96420-13</a> 7.6 m (25 ft)/pk	<a href="#">HL-96420-14</a> 7.6 m (25 ft)/pk	<a href="#">HL-96420-16</a> 7.6 m (25 ft)/pk	<a href="#">HL-96420-25</a> 7.6 m (25 ft)/pk	<a href="#">HL-96420-17</a> 7.6 m (25 ft)/pk	<a href="#">HL-96420-18</a> 7.6 m (25 ft)/pk
 BioPharm Plus silicone (platinum-cured)	✓	✓	✓	✓	✓	<a href="#">HL-96440-13</a> 7.6 m (25 ft)/pk	<a href="#">HL-96440-14</a> 7.6 m (25 ft)/pk	<a href="#">HL-96440-16</a> 7.6 m (25 ft)/pk	<a href="#">HL-96440-25</a> 7.6 m (25 ft)/pk	<a href="#">HL-96440-17</a> 7.6 m (25 ft)/pk	<a href="#">HL-96440-18</a> 7.6 m (25 ft)/pk
 Puri-Flex™	✓	✓	✓	✓	✓	<a href="#">HL-96419-13</a> 7.6 m (25 ft)/pk	<a href="#">HL-96419-14</a> 7.6 m (25 ft)/pk	<a href="#">HL-96419-16</a> 7.6 m (25 ft)/pk	<a href="#">HL-96419-25</a> 7.6 m (25 ft)/pk	<a href="#">HL-96419-17</a> 7.6 m (25 ft)/pk	<a href="#">HL-96419-18</a> 7.6 m (25 ft)/pk
 C-Flex®	✓	✓	✓	✓	✓	<a href="#">HL-06424-13</a> 7.6 m (25 ft)/pk	<a href="#">HL-06424-14</a> 7.6 m (25 ft)/pk	<a href="#">HL-06424-16</a> 7.6 m (25 ft)/pk	<a href="#">HL-06424-25</a> 7.6 m (25 ft)/pk	<a href="#">HL-06424-17</a> 7.6 m (25 ft)/pk	<a href="#">HL-06424-18</a> 7.6 m (25 ft)/pk
 C-Flex® ULTRA	✓	✓	✓	✓	✓	—	<a href="#">HL-06434-14</a> 7.6 m (25 ft)/pk	<a href="#">HL-06434-16</a> 7.6 m (25 ft)/pk	<a href="#">HL-06434-25</a> 7.6 m (25 ft)/pk	<a href="#">HL-06434-17</a> 7.6 m (25 ft)/pk	<a href="#">HL-06434-18</a> 7.6 m (25 ft)/pk
 PharMed® BPT	✓	✓	✓	✓	✓	<a href="#">HL-06508-13</a> 7.6 m (25 ft)/pk	<a href="#">HL-06508-14</a> 7.6 m (25 ft)/pk	<a href="#">HL-06508-16</a> 7.6 m (25 ft)/pk	<a href="#">HL-06508-25</a> 7.6 m (25 ft)/pk	<a href="#">HL-06508-17</a> 7.6 m (25 ft)/pk	<a href="#">HL-06508-18</a> 7.6 m (25 ft)/pk
 PharmaPure®	✓	✓				<a href="#">HL-06435-13</a> 7.6 m (25 ft)/pk	<a href="#">HL-06435-14</a> 7.6 m (25 ft)/pk	<a href="#">HL-06435-16</a> 7.6 m (25 ft)/pk	<a href="#">HL-06435-25</a> 7.6 m (25 ft)/pk	<a href="#">HL-06435-17</a> 7.6 m (25 ft)/pk	<a href="#">HL-06435-18</a> 7.6 m (25 ft)/pk



SEE PAGES 20 TO 24

For detailed formulation descriptions and specifications.

## ORDERING INFORMATION

Pump tubing formulation	L/S Pump Head Compatibility					L/S 13	L/S 14	L/S 16	L/S 25	L/S 17	L/S 18
	Standard	Easy-Load®	Easy-Load II	Easy-Load 3	Multichannel Cartridge						
<b>Chem-Durance® Bio</b>		✓	✓			<a href="#">HL-06442-13</a> 15.2 m (50 ft)/pk	<a href="#">HL-06442-14</a> 15.2 m (50 ft)/pk	<a href="#">HL-06442-16</a> 15.2 m (50 ft)/pk	<a href="#">HL-06442-25</a> 15.2 m (50 ft)/pk	<a href="#">HL-06442-17</a> 15.2 m (50 ft)/pk	<a href="#">HL-06442-18</a> 15.2 m (50 ft)/pk
<b>Tygon® E-LFL</b> <b>NEW</b>	✓	✓	✓	✓	✓	<a href="#">HL-06440-13</a> 7.6 m (25 ft)/pk	<a href="#">HL-06440-14</a> 7.6 m (25 ft)/pk	<a href="#">HL-06440-16</a> 7.6 m (25 ft)/pk	<a href="#">HL-06440-25</a> 7.6 m (25 ft)/pk	<a href="#">HL-06440-17</a> 7.6 m (25 ft)/pk	<a href="#">HL-06440-18</a> 7.6 m (25 ft)/pk
<b>Tygon® E-Food (B-44-4X)</b> <b>NEW</b>	✓	✓	✓	✓	✓	<a href="#">HL-06418-13</a> 15.2 m (50 ft)/pk	<a href="#">HL-06418-14</a> 15.2 m (50 ft)/pk	<a href="#">HL-06418-16</a> 15.2 m (50 ft)/pk	<a href="#">HL-06418-25</a> 15.2 m (50 ft)/pk	<a href="#">HL-06418-17</a> 15.2 m (50 ft)/pk	<a href="#">HL-06418-18</a> 15.2 m (50 ft)/pk
<b>Tygon® E-Lab (E-3603)</b> <b>NEW</b>	✓	✓	✓	✓	✓	<a href="#">HL-06509-13</a> 15.2 m (50 ft)/pk	<a href="#">HL-06509-14</a> 15.2 m (50 ft)/pk	<a href="#">HL-06509-16</a> 15.2 m (50 ft)/pk	<a href="#">HL-06509-25</a> 15.2 m (50 ft)/pk	<a href="#">HL-06509-17</a> 15.2 m (50 ft)/pk	<a href="#">HL-06509-18</a> 15.2 m (50 ft)/pk
<b>Tygon® Fuel &amp; Lubricant (F-4040-A)</b>	✓	✓	✓	✓	✓	<a href="#">HL-06401-13</a> 15.2 m (50 ft)/pk	<a href="#">HL-06401-14</a> 15.2 m (50 ft)/pk	<a href="#">HL-06401-16</a> 15.2 m (50 ft)/pk	<a href="#">HL-06401-25</a> 15.2 m (50 ft)/pk	<a href="#">HL-06401-17</a> 15.2 m (50 ft)/pk	<a href="#">HL-06401-18</a> 15.2 m (50 ft)/pk
<b>Tygon® Chemical (2001)</b>		✓	✓			<a href="#">HL-06475-13</a> 15.2 m (50 ft)/pk	<a href="#">HL-06475-14</a> 15.2 m (50 ft)/pk	<a href="#">HL-06475-16</a> 15.2 m (50 ft)/pk	<a href="#">HL-06475-25</a> 15.2 m (50 ft)/pk	<a href="#">HL-06475-17</a> 15.2 m (50 ft)/pk	<a href="#">HL-06475-18</a> 15.2 m (50 ft)/pk
<b>Norprene® (A 60 G)</b>	✓	✓	✓	✓	✓	<a href="#">HL-06404-13</a> 15.2 m (50 ft)/pk	<a href="#">HL-06404-14</a> 15.2 m (50 ft)/pk	<a href="#">HL-06404-16</a> 15.2 m (50 ft)/pk	<a href="#">HL-06404-25</a> 15.2 m (50 ft)/pk	<a href="#">HL-06404-17</a> 15.2 m (50 ft)/pk	<a href="#">HL-06404-18</a> 15.2 m (50 ft)/pk
<b>Norprene® Food (A 60 F)</b>	✓	✓	✓	✓	✓	<a href="#">HL-06402-13</a> 15.2 m (50 ft)/pk	<a href="#">HL-06402-14</a> 15.2 m (50 ft)/pk	<a href="#">HL-06402-16</a> 15.2 m (50 ft)/pk	<a href="#">HL-06402-25</a> 15.2 m (50 ft)/pk	<a href="#">HL-06402-17</a> 15.2 m (50 ft)/pk	<a href="#">HL-06402-18</a> 15.2 m (50 ft)/pk
<b>GORE® Style 100SC</b>	✓	✓	✓			—	<a href="#">HL-96190-14</a> 30.5 cm (12")/pk	<a href="#">HL-96190-16</a> 30.5 cm (12")/pk	<a href="#">HL-96190-25</a> 30.5 cm (12")/pk	<a href="#">HL-96190-17</a> 30.5 cm (12")/pk	<a href="#">HL-96190-18</a> 30.5 cm (12")/pk
<b>GORE® Style 500</b>	✓	✓	✓			—	<a href="#">HL-96191-14</a> 30.5 cm (12")/pk	<a href="#">HL-96191-16</a> 30.5 cm (12")/pk	<a href="#">HL-96191-25</a> 30.5 cm (12")/pk	<a href="#">HL-96191-17</a> 30.5 cm (12")/pk	<a href="#">HL-96191-18</a> 30.5 cm (12")/pk
<b>GORE® Style 400</b>	✓	✓	✓			—	—	<a href="#">HL-06439-16</a> 30.5 cm (12")/pk	—	<a href="#">HL-06439-17</a> 30.5 cm (12")/pk	—
<b>Viton®</b>	✓	✓	✓	✓	✓	<a href="#">HL-96412-13</a> 7.6 m (25 ft)/pk	<a href="#">HL-96412-14</a> 7.6 m (25 ft)/pk	<a href="#">HL-96412-16</a> 7.6 m (25 ft)/pk	<a href="#">HL-96412-25</a> 7.6 m (25 ft)/pk	<a href="#">HL-96412-17</a> 7.6 m (25 ft)/pk	<a href="#">HL-96412-18</a> 7.6 m (25 ft)/pk



## FILLER/DISPENSING NOZZLES

- ▶ Maximize the speed, precision, and accuracy of dispensing and filling applications
- ▶ Minimize splashing and dripping when dispensing into narrow- or wide-mouth containers
- ▶ Dimensional tolerances of ±0.05% for assured repeatability

These nozzles combine the ease of plastic components with the accuracy and reliability of stainless steel filler needles. Tight dimensional tolerances help to ensure precision in your dispensing applications. Nozzles feature a 316L stainless steel tube and a polycarbonate base with hose barb adapter. Materials comply with FDA, USDA and USP Class VI requirements. All filler nozzles are sterilizable by ethylene oxide, autoclaving, or gamma irradiation.

Catalog number	Tubing ID	Fits Masterflex® tubing sizes
<a href="#">HL-30619-06</a>	1/32"	L/S® 13
<a href="#">HL-30619-01</a>	1/16"	L/S 14
<a href="#">HL-30619-07</a>	1/8"	L/S 16
<a href="#">HL-30619-02</a>	3/16"	L/S 15, 25
<a href="#">HL-30619-08</a>	1/4"	L/S 17, 24; I/P® 26
<a href="#">HL-30619-03</a>	5/16"	L/S 35
<a href="#">HL-30619-09</a>	3/8"	L/S 18, 36; I/P 70, 73; B/T® 86
<a href="#">HL-30619-04</a>	1/2"	I/P 82, 88; B/T 87
<a href="#">HL-30619-10</a>	5/8"	I/P 89
<a href="#">HL-30619-05</a>	3/4"	B/T 91

30619-08

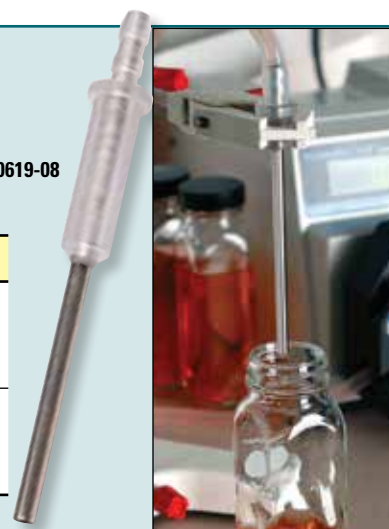





## L/S® HIGH-PERFORMANCE PRECISION PUMP TUBING

- Ensure optimal performance from your Masterflex pump
- Custom extruded to fit Masterflex pumps
- Engineered for long life in peristaltic pump applications
- Lot-to-lot consistency provides superior accuracy and repeatability

Masterflex L/S pump tubing is manufactured to extremely close tolerances that match our L/S pump heads, ensuring accurate, repeatable flow and long tubing life. Our pump tubing is factory-tested and optically inspected to provide the best performance from your peristaltic pump. With 21 different materials available, there is an L/S pump tubing formulation suitable for nearly any fluid handling application.

Our High-performance Precision pump tubing features a thicker wall compared to our Precision pump tubing, making it the best choice for applications involving pressure, suction lift, viscous fluids, or long tubing life.







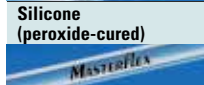

### SPECIFICATIONS

Pump tubing cross sections	L/S High-performance Precision pump tubing			
				
	L/S 15	L/S 24	L/S 35	L/S 36
Inside diameter (nominal)	4.8 mm (0.19")	6.4 mm (0.25")	7.9 mm (0.31")	9.7 mm (0.38")
Hose barb size	4.8 mm (3/16")	6.4 mm (1/4")	9.5 mm (3/8")	9.5 mm (3/8")
Flow range (approximate) <sup>†</sup> with 1 to 600 rpm drive Value in ( ) obtained with High-Performance pump head	1.7 to 1000 mL/min (1.8 to 1100 mL/min)	2.8 to 1700 mL/min (3.0 to 1800 mL/min)	3.8 to 2300 mL/min (4.3 to 2600 mL/min)	4.8 to 2900 mL/min (5.8 to 3400 mL/min)
Maximum pressure <sup>‡</sup>	2.7 bar (40 psig)		2.4 bar (35 psig)	1.4 bar (20 psig)
Maximum vacuum <sup>‡</sup>	660 mm Hg (26" Hg)			610 mm Hg (24" Hg)
Suction lift <sup>‡</sup>	8.8 m H <sub>2</sub> O (29 ft H <sub>2</sub> O)			8.3 m H <sub>2</sub> O (27 ft H <sub>2</sub> O)

<sup>†</sup>Determined under the following conditions: 0 psi at inlet, 0.5 psi at outlet; water temperature at 22°C (72°F).

<sup>‡</sup>Actual performance varies depending on tubing formulation—values shown are for firm tubing. Value for GORE® pump tubing is 4.1 bar (60 psi) continuous.

### ORDERING INFORMATION

Pump tubing formulation	L/S Pump Head Compatibility					L/S 15	L/S 24	L/S 35	L/S 36
	Standard	Easy-Load®	Easy-Load II	Easy-Load 3	High-Performance				
 Silicone (platinum-cured)	✓	✓	✓	✓	✓	<a href="#">HL-96410-15</a> 7.6 m (25 ft)/pk	<a href="#">HL-96410-24</a> 7.6 m (25 ft)/pk	<a href="#">HL-96410-35</a> 7.6 m (25 ft)/pk	<a href="#">HL-96410-36</a> 7.6 m (25 ft)/pk
 Silicone (peroxide-cured)	✓	✓	✓	✓	✓	<a href="#">HL-96400-15</a> 7.6 m (25 ft)/pk	<a href="#">HL-96400-24</a> 7.6 m (25 ft)/pk	<a href="#">HL-96400-35</a> 7.6 m (25 ft)/pk	<a href="#">HL-96400-36</a> 7.6 m (25 ft)/pk
 BioPharm silicone (platinum-cured)	✓	✓	✓	✓	✓	<a href="#">HL-96420-15</a> 7.6 m (25 ft)/pk	<a href="#">HL-96420-24</a> 7.6 m (25 ft)/pk	<a href="#">HL-96420-35</a> 7.6 m (25 ft)/pk	<a href="#">HL-96420-36</a> 7.6 m (25 ft)/pk
 BioPharm Plus silicone (platinum-cured)	✓	✓	✓	✓	✓	<a href="#">HL-96440-15</a> 7.6 m (25 ft)/pk	<a href="#">HL-96440-24</a> 7.6 m (25 ft)/pk	<a href="#">HL-96440-35</a> 7.6 m (25 ft)/pk	<a href="#">HL-96440-36</a> 7.6 m (25 ft)/pk
 Puri-Flex™	✓	✓	✓	✓	✓	<a href="#">HL-96419-15</a> 7.6 m (25 ft)/pk	<a href="#">HL-96419-24</a> 7.6 m (25 ft)/pk	<a href="#">HL-96419-35</a> 7.6 m (25 ft)/pk	<a href="#">HL-96419-36</a> 7.6 m (25 ft)/pk
 C-Flex®	✓	✓	✓	✓	✓	<a href="#">HL-06424-15</a> 7.6 m (25 ft)/pk	<a href="#">HL-06424-24</a> 7.6 m (25 ft)/pk	<a href="#">HL-06424-35</a> 7.6 m (25 ft)/pk	<a href="#">HL-06424-36</a> 7.6 m (25 ft)/pk
 C-Flex® ULTRA	✓	✓	✓	✓	✓	<a href="#">HL-06434-15</a> 7.6 m (25 ft)/pk	<a href="#">HL-06434-24</a> 7.6 m (25 ft)/pk	<a href="#">HL-06434-35</a> 7.6 m (25 ft)/pk	<a href="#">HL-06434-36</a> 7.6 m (25 ft)/pk
 PharMed® BPT	✓	✓	✓	✓	✓	<a href="#">HL-06508-15</a> 7.6 m (25 ft)/pk	<a href="#">HL-06508-24</a> 7.6 m (25 ft)/pk	<a href="#">HL-06508-35</a> 7.6 m (25 ft)/pk	<a href="#">HL-06508-36</a> 7.6 m (25 ft)/pk
 PharmaPure®		✓	✓			<a href="#">HL-06435-15</a> 7.6 m (25 ft)/pk	<a href="#">HL-06435-24</a> 7.6 m (25 ft)/pk	—	—





## ORDERING INFORMATION

Pump tubing formulation	L/S Pump Head Compatibility					L/S 15	L/S 24	L/S 35	L/S 36
	Standard	Easy-Load®	Easy-Load II	Easy-Load 3	High-Performance				
<b>Chem-Durance® Bio</b> 		✓	✓			<a href="#">HL-06442-15</a> 15.2 m (50 ft)/pk	<a href="#">HL-06442-24</a> 15.2 m (50 ft)/pk	<a href="#">HL-06442-35</a> 15.2 m (50 ft)/pk	<a href="#">HL-06442-36</a> 15.2 m (50 ft)/pk
<b>Tygon® E-LFL</b> <b>NEW</b> 	✓	✓	✓	✓	✓	<a href="#">HL-06440-15</a> 7.6 m (25 ft)/pk	<a href="#">HL-06440-24</a> 7.6 m (25 ft)/pk	<a href="#">HL-06440-35</a> 7.6 m (25 ft)/pk	<a href="#">HL-06440-36</a> 7.6 m (25 ft)/pk
<b>Tygon® E-Food (B-44-4X)</b> <b>NEW</b> 		✓	✓	✓	✓	<a href="#">HL-06418-15</a> 15.2 m (50 ft)/pk	<a href="#">HL-06418-24</a> 15.2 m (50 ft)/pk	<a href="#">HL-06418-35</a> 15.2 m (50 ft)/pk	<a href="#">HL-06418-36</a> 15.2 m (50 ft)/pk
<b>Tygon® E-Lab (E-3603)</b> <b>NEW</b> 	✓	✓	✓	✓	✓	<a href="#">HL-06509-15</a> 15.2 m (50 ft)/pk	<a href="#">HL-06509-24</a> 15.2 m (50 ft)/pk	<a href="#">HL-06509-35</a> 15.2 m (50 ft)/pk	<a href="#">HL-06509-36</a> 15.2 m (50 ft)/pk
<b>Tygon® Fuel &amp; Lubricant (F-4040-A)</b> 	✓	✓	✓	✓	✓	<a href="#">HL-06401-15</a> 15.2 m (50 ft)/pk	<a href="#">HL-06401-24</a> 15.2 m (50 ft)/pk	<a href="#">HL-06401-35</a> 15.2 m (50 ft)/pk	<a href="#">HL-06401-36</a> 15.2 m (50 ft)/pk
<b>Tygon® Chemical (2001)</b> 		✓	✓			<a href="#">HL-06475-15</a> 15.2 m (50 ft)/pk	<a href="#">HL-06475-24</a> 15.2 m (50 ft)/pk	—	—
<b>Norprene® (A 60 G)</b> 	✓	✓	✓	✓	✓	<a href="#">HL-06404-15</a> 15.2 m (50 ft)/pk	<a href="#">HL-06404-24</a> 15.2 m (50 ft)/pk	<a href="#">HL-06404-35</a> 15.2 m (50 ft)/pk	<a href="#">HL-06404-36</a> 15.2 m (50 ft)/pk
<b>Norprene® Food (A 60 F)</b> 	✓	✓	✓	✓	✓	<a href="#">HL-06402-15</a> 15.2 m (50 ft)/pk	<a href="#">HL-06402-24</a> 15.2 m (50 ft)/pk	<a href="#">HL-06402-35</a> 15.2 m (50 ft)/pk	<a href="#">HL-06402-36</a> 15.2 m (50 ft)/pk
<b>GORe® Style 100SC</b> 	✓	✓	✓		✓	<a href="#">HL-96190-15</a> 35.6 cm (14")/pk	<a href="#">HL-96190-24</a> 35.6 cm (14")/pk	<a href="#">HL-96190-35</a> 35.6 cm (14")/pk	—
<b>GORe® Style 500</b> 	✓	✓	✓		✓	<a href="#">HL-96191-15</a> 35.6 cm (14")/pk	<a href="#">HL-96191-24</a> 35.6 cm (14")/pk	<a href="#">HL-96191-35</a> 35.6 cm (14")/pk	—
<b>GORe® Style 400</b> 	✓	✓	✓		✓	<a href="#">HL-06439-15</a> 35.6 cm (14")/pk	<a href="#">HL-06439-24</a> 34.2 cm (13.5")/pk	<a href="#">HL-06439-35</a> 35.6 cm (14")/pk	<a href="#">HL-06439-36</a> 35.6 cm (14")/pk
<b>Viton®</b> 	✓	✓	✓	✓	✓	<a href="#">HL-96412-15</a> 7.6 m (25 ft)/pk	<a href="#">HL-96412-24</a> 7.6 m (25 ft)/pk	<a href="#">HL-96412-35</a> 7.6 m (25 ft)/pk	<a href="#">HL-96412-36</a> 7.6 m (25 ft)/pk



## BASKET-TIP FILLER NOZZLES

- ▶ Reduce foaming and splashing
- ▶ Lower costs for cleaning, sterilization, and validation

These nozzles offer the benefits of the standard filler/dispensing nozzles by combining the ease of single-use plastic components with the accuracy and reliability of stainless steel filler needles. Plus, nozzles feature a basket tube tip that has two outlets angled at 10° to split the flow into two streams, forcing the fluid to gently cascade down the sides of your container. This basket tip is especially useful for liquids that have issues with foaming or splashing and/or maintaining a fluid column.

Tight dimensional tolerances help to ensure precision in your dispensing applications. Nozzles feature a 316L stainless steel tube and a base with hose barb adapter. Materials comply with FDA, USDA and USP Class VI requirements. All filler nozzles are sterilizable by ethylene oxide, autoclaving, or gamma irradiation.

Catalog number	Tubing ID	Fits Masterflex® tubing sizes
<a href="#">HL-30619-11</a>	1/16"	L/S® 14
<a href="#">HL-30619-17</a>	1/8"	L/S 16
<a href="#">HL-30619-12</a>	3/16"	L/S 15, 25
<a href="#">HL-30619-18</a>	1/4"	L/S 17, 24, I/P® 26
<a href="#">HL-30619-13</a>	5/16"	L/S 35
<a href="#">HL-30619-19</a>	3/8"	L/S 18, 36, I/P 70, 73
<a href="#">HL-30619-15</a>	3/4"	B/T® 91

**NEW**



## L/S® SANITARY PUMP TUBING ASSEMBLIES

### FEATURES/BENEFITS

- Meets stringent demands of biotechnology, pharmaceutical, and the food, beverage, and dairy processing industries
- Smooth, pre-molded tubing ends allow quick connection to an adapter or to another length of sanitary tubing
- Connectors help maintain cleanliness and purity of your fluids
- Sanitary tubing is less thermally conductive than metallic tubing systems and not subject to galvanic action, RFI, or EMI
- All L/S platinum-cured silicone and PharMed® BPT sanitary tubing complies with USP Class VI and FDA standards
- FREE Certificate of resin or elastomer Compliance is available upon request

Platinum-cured silicone tubing with premolded 1/2" mini connections



### HOW TO CONNECT TUBING

- Each length of tubing features pre-molded ends. Tubing with 1/2" mini-connections uses molded-in gasket at one end to ensure quality seal.
- Pre-molded ends allow quick connection to an adapter or additional length of sanitary tubing. Order adapters below, right.
- Join 1/2" mini-connection to another 1/2" mini-connection, adapter, or to your system with a push/pull clamp.

### HOW TO ORDER

- Order your desired tubing formulation and length. Choose tubing size based on flow range (see "Specifications" on pages 66 and 68).
- Order PVDF push/pull clamp (separately below).
- Order silicone or Viton® gaskets as needed to connect to your system or to adapters.
- Select sanitary adapters as needed.



### ORDERING INFORMATION

Tubing size	Platinum-cured silicone (96410-series) 1.5-m (5-ft) length	Platinum-cured silicone (96410-series) 3-m (10-ft) length	PharMed BPT (06508-series) 1.5-m (5-ft) length	PharMed BPT (06508-series) 3-m (10-ft) length
	Catalog number	Catalog number	Catalog number	Catalog number
<b>L/S Precision sanitary pump tubing</b>				
L/S 13	<a href="#">HL-96100-13</a>	<a href="#">HL-96101-13</a>	<a href="#">HL-96112-13</a>	<a href="#">HL-96113-13</a>
L/S 14	<a href="#">HL-96100-14</a>	<a href="#">HL-96101-14</a>	<a href="#">HL-96112-14</a>	<a href="#">HL-96113-14</a>
L/S 16	<a href="#">HL-96100-16</a>	<a href="#">HL-96101-16</a>	<a href="#">HL-96112-16</a>	<a href="#">HL-96113-16</a>
L/S 25	<a href="#">HL-96100-25</a>	<a href="#">HL-96101-25</a>	<a href="#">HL-96112-25</a>	<a href="#">HL-96113-25</a>
L/S 17	<a href="#">HL-96100-17</a>	<a href="#">HL-96101-17</a>	<a href="#">HL-96112-17</a>	<a href="#">HL-96113-17</a>
L/S 18	<a href="#">HL-96100-18</a>	<a href="#">HL-96101-18</a>	<a href="#">HL-96112-18</a>	<a href="#">HL-96113-18</a>
<b>L/S High-performance Precision sanitary pump tubing</b>				
L/S 15	<a href="#">HL-96100-15</a>	<a href="#">HL-96101-15</a>	<a href="#">HL-96112-15</a>	<a href="#">HL-96113-15</a>
L/S 24	<a href="#">HL-96100-24</a>	<a href="#">HL-96101-24</a>	<a href="#">HL-96112-24</a>	<a href="#">HL-96113-24</a>
L/S 35	—	—	<a href="#">HL-96112-35</a>	<a href="#">HL-96113-35</a>
L/S 36	—	—	<a href="#">HL-96112-36</a>	<a href="#">HL-96113-36</a>

### ACCESSORIES FOR L/S SANITARY PUMP TUBING

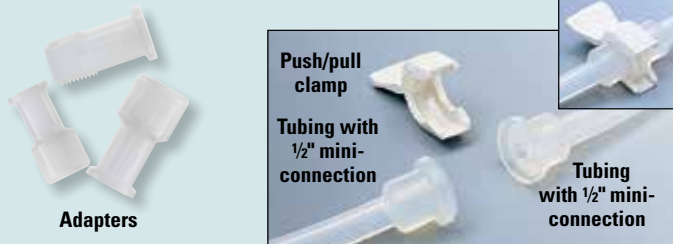

Adapters

Push/pull clamp

Tubing with 1/2" mini-connection

Tubing with 1/2" mini-connection

**HL-31201-88 Push/pull clamp**, PVDF. For quick joining of two 1/2" mini connections.

**Gaskets.** Order gaskets to join 1/2" mini connection without molded-in gasket to another 1/2" mini connection without molded-in gasket or to an adapter (sold separately at right).

**HL-30548-00 Silicone gasket** for use with sanitary silicone (platinum-cured) tubing. Pack of 10.

**HL-30548-20 Viton® gasket** for use with sanitary PharMed® BPT tubing. Pack of 10.

### ADAPTER ORDERING INFORMATION

Adapter connections	Polypropylene	PVDF
	Catalog number	Catalog number
1/2" mini to 1/8" NPT(M)	<a href="#">HL-31200-00</a>	<a href="#">HL-31201-00</a>
1/2" mini to 1/8" NPT(F)	<a href="#">HL-31200-10</a>	—
1/2" mini to 1/4" NPT(M)	<a href="#">HL-31200-01</a>	<a href="#">HL-31201-01</a>
1/2" mini to 1/4" NPT(F)	<a href="#">HL-31200-11</a>	<a href="#">HL-31201-11</a>
1/2" mini to 1/4" hose barb	<a href="#">HL-31805-25</a>	<a href="#">HL-31808-25</a>
1/2" mini to 3/8" NPT(M)	<a href="#">HL-31200-02</a>	<a href="#">HL-31201-02</a>
1/2" mini to 3/8" NPT(F)	<a href="#">HL-31200-12</a>	<a href="#">HL-31201-12</a>
1/2" mini to 3/8" hose barb	<a href="#">HL-31805-26</a>	<a href="#">HL-31808-26</a>
1/2" mini to 1/2" NPT(M)	<a href="#">HL-31200-03</a>	<a href="#">HL-31201-03</a>
1/2" mini to 1/2" NPT(F)	<a href="#">HL-31200-13</a>	<a href="#">HL-31201-13</a>
1/2" mini to 1/2" hose barb	<a href="#">HL-31805-27</a>	—
1/2" mini to 1" maxi	<a href="#">HL-31200-30</a>	—
1/2" mini to 1" lardish	<a href="#">HL-31805-05</a>	<a href="#">HL-31201-40</a>
1/2" mini to female luer lock	<a href="#">HL-31200-50</a>	<a href="#">HL-31201-50</a>



## L/S<sup>®</sup> SPOOLED PUMP TUBING

- ▶ Eliminate waste by cutting the exact length to fit your application
- ▶ Cost-effective, efficient, and convenient
- ▶ Up to 152.4 m (500 ft) of tubing (depending on tubing size) on each spool.
- ▶ Always have enough tubing on hand
- ▶ Save space and shipping costs
- ▶ Good choice for applications requiring long, continuous runs of tubing, or which use odd-size lengths that generate scrap when using standard 7.6- or 15.2-m (25- or 50-ft) coils



96403-15

**Save Money  
and Reduce Downtime!**

### ORDERING INFORMATION

Tubing size	Peroxide-cured silicone (96400-series)		Platinum-cured silicone (96410-series)		PharMed <sup>®</sup> BPT (06508-series)		BioPharm Silicone (96420-series)		C-Flex <sup>®</sup> (06424-series)		Norprene <sup>®</sup> Food (06402-series)	
	m (ft)	Catalog number	m (ft)	Catalog number	m (ft)	Catalog number	m (ft)	Catalog number	m (ft)	Catalog number	m (ft)	Catalog number
L/S 13	76.2 (250)	<a href="#">HL-96407-13</a>	152.4 (500)	<a href="#">HL-96403-13</a>	—	—	—	—	121.9 (400)	<a href="#">HL-06427-13</a>	—	—
L/S 14	76.2 (250)	<a href="#">HL-96407-14</a>	152.4 (500)	<a href="#">HL-96403-14</a>	152.4 (500)	<a href="#">HL-95687-14</a>	121.9 (400)	<a href="#">HL-96423-14</a>	121.9 (400)	<a href="#">HL-06427-14</a>	152.4 (500)	<a href="#">HL-06415-14</a>
L/S 16	76.2 (250)	<a href="#">HL-96407-16</a>	152.4 (500)	<a href="#">HL-96403-16</a>	152.4 (500)	<a href="#">HL-95687-16</a>	121.9 (400)	<a href="#">HL-96423-16</a>	121.9 (400)	<a href="#">HL-06427-16</a>	152.4 (500)	<a href="#">HL-06415-16</a>
L/S 25	76.2 (250)	<a href="#">HL-96407-25</a>	152.4 (500)	<a href="#">HL-96403-25</a>	—	—	121.9 (400)	<a href="#">HL-96423-25</a>	121.9 (400)	<a href="#">HL-06427-25</a>	—	—
L/S 17	76.2 (250)	<a href="#">HL-96407-17</a>	152.4 (500)	<a href="#">HL-96403-17</a>	152.4 (500)	<a href="#">HL-95687-17</a>	121.9 (400)	<a href="#">HL-96423-17</a>	121.9 (400)	<a href="#">HL-06427-17</a>	—	—
L/S 18	61.0 (200)	<a href="#">HL-96407-18</a>	121.9 (400)	<a href="#">HL-96403-18</a>	121.9 (400)	<a href="#">HL-95687-18</a>	121.9 (400)	<a href="#">HL-96423-18</a>	121.9 (400)	<a href="#">HL-06427-18</a>	—	—
L/S 15	76.2 (250)	<a href="#">HL-96407-15</a>	121.9 (400)	<a href="#">HL-96403-15</a>	121.9 (400)	<a href="#">HL-95687-15</a>	121.9 (400)	<a href="#">HL-96423-15</a>	121.9 (400)	<a href="#">HL-06427-15</a>	—	—
L/S 24	61.0 (200)	<a href="#">HL-96407-24</a>	91.4 (300)	<a href="#">HL-96403-24</a>	91.4 (300)	<a href="#">HL-95687-24</a>	121.9 (400)	<a href="#">HL-96423-24</a>	121.9 (400)	<a href="#">HL-06427-24</a>	—	—
L/S 35	—	—	91.4 (300)	<a href="#">HL-96403-35</a>	91.4 (300)	<a href="#">HL-95687-35</a>	—	—	121.9 (400)	<a href="#">HL-06427-35</a>	—	—
L/S 36	—	—	30.5 (100)	<a href="#">HL-96403-36</a>	30.5 (100)	<a href="#">HL-95687-36</a>	—	—	121.9 (400)	<a href="#">HL-06427-36</a>	—	—

## L/S<sup>®</sup> BULK-PACKED PUMP TUBING

- ▶ Save on shipping costs and reduce storage space
- ▶ Up to 20 sealed bags of tubing (depending on tubing size) in each case
- ▶ Lot-traceable certificates of tubing compliance available
- ▶ Use as many or as few as you need and store the rest
- ▶ Tubing coils are individually bagged and sealed to prevent contamination



96404-16

### ORDERING INFORMATION

Tubing size	Number of 7.6-m (25-ft) bags per box	Platinum-cured silicone (96410-series)	C-Flex <sup>®</sup> (06424-series)
		Catalog number	Catalog number
L/S 13	20	<a href="#">HL-96404-13</a>	<a href="#">HL-06436-13</a>
L/S 14	20	<a href="#">HL-96404-14</a>	<a href="#">HL-06436-14</a>
L/S 16	20	<a href="#">HL-96404-16</a>	—
L/S 25	20	<a href="#">HL-96404-25</a>	<a href="#">HL-06436-25</a>
L/S 17	20	<a href="#">HL-96404-17</a>	<a href="#">HL-06436-17</a>
L/S 18	10	<a href="#">HL-96404-18</a>	—
L/S 15	20	<a href="#">HL-96404-15</a>	<a href="#">HL-06436-15</a>
L/S 24	20	<a href="#">HL-96404-24</a>	<a href="#">HL-06436-24</a>
L/S 35	10	<a href="#">HL-96404-35</a>	<a href="#">HL-06436-35</a>
L/S 36	10	<a href="#">HL-96404-36</a>	<a href="#">HL-06436-36</a>

### ACCESSORIES FOR L/S PRECISION PUMP TUBING

#### Benchtop Tubing Cutter

Steel blade makes right-angle cuts in several sizes of Masterflex tubing:

C/L<sup>®</sup> 2.06 mm, 2.79 mm OD  
L/S<sup>®</sup> sizes 13, 14, 15, 16, 17, 18, 24, 25, 35, 36  
I/P<sup>®</sup> sizes 26, 73



06438-10

[HL-06438-10](#) Benchtop tubing cutter

[HL-06438-11](#) Replacement blade for 06438-10





#### Pulse Dampener

Virtually eliminate pulsation in your output flow. Pulse dampener features a polyethylene body. It includes five pairs of fittings and PTFE-pipe thread tape. Pulse dampener accepts all L/S tubing sizes and I/P 26 size tubing.



[HL-07596-20](#) Pulse dampener

## SELECTION GUIDE FOR LS® DRIVES

		Description	Flow rates (mL/min)	Fixed speed (rpm)	Variable speed (rpm)	Reversible	Remote control capabilities	Special features	Page number
Analog	FIXED-SPEED								
			Lowest: 0.06 Highest: 290	1, 2, 6, 12, 20, 30, 60	—	—	—	Consistent repeatable flow rates. Economical and compact. UL, cUL, and CE listed models	76–77
	COMPACT								
		Lowest: 0.8 Highest: 560	—	20 to 100, 35 to 200	✓	Start/stop	Economical and compact. UL, cUL, and CE listed models. Compact pump with integral pump head and quick-loading tube sets—single or dual channel. Drives are stackable.	78–81	
ECONOMY CONSOLE									
		Lowest: 0.42 Highest: 2900	—	7 to 200, 20 to 600	✓	—	Economical variable flow; simple speed control. UL, cUL, and CE listed models. Drives accept stacked pump heads for multiple channels.	82–83	
Specialty	AIR-POWERED AND HAZARDOUS-DUTY								
			Lowest: 0.6 Highest: 3400	—	60 to 600	—	—	Use air-powered drives in locations where electricity is unsafe or impractical. Air drive is ATEX Zone 2 approved. Stack pump heads.	101–102
	SAMPLERS								
		Lowest: 4.2 Highest: 1650	600	70 to 400	✓	—	Samplers float up to 30 minutes if inadvertently dropped in water. Rechargeable internal batteries for field use. Ideal for sampling in the field or in the plant as a portable pump. Programmable digital composite samplers available.	104–106	
DC-POWERED									
		Lowest: 1.2 Highest: 2700	100, 540, 570	20 to 90, 100 to 500	✓	—	Operate from 12 or 24 VDC supply. Versatile, portable, and easy to use.	107	



Description	Flow rates (mL/min)	Fixed speed (rpm)	Variable speed (rpm)	Reversible	Remote control capabilities	Special features	Page number
<b>PRECISION CONSOLE</b>							
	Lowest: 0.06 Highest: 3400	—	1 to 100, 3 to 300, 6 to 600	✓	Speed, start/ stop, direction	Economical variable flow; simple speed control. ETL and CE listed models. Drives accept stacked pump heads for multiple channels. Drives are stackable.	84–85
<b>PRECISION MODULAR</b>							
 <b>NEW</b>	Lowest: 0.06 Highest: 3400	—	1 to 100, 6 to 600	✓	Speed, start/stop, direction	Separate motor and controller up to 4.6 m (15 ft). Models available with either benchtop or IP66-rated wall-mount controller. Pump heads can be stacked.	86–87
<b>STANDARD DIGITAL AND COMPUTER COMPATIBLE</b>							
	Lowest: 0.001 Highest: 3400	—	0.1 to 600, 0.02 to 100	✓	Speed, direction, start/stop, prime	Four-line graphical LCD with menu-driven programming. Maintenance-free brushless motor. PWM speed control with 6000:1 turndown. Tachometer feedback for ±0.1% speed control. Housings are stackable. Calibration capability. Programmable for all L/S tubing sizes. Pump heads can be stacked. Control brushless computerized drive with Windows®-based software; stores up to 30 user programs. Use as stand-alone or programmable drives.	88–89, 94–95
<b>MODULAR DISPENSERS</b>							
 <b>NEW</b>	Lowest: 0.001 Highest: 3400	—	0.1 to 600	✓	Speed, direction, start/stop, prime	Maintenance-free brushless motor. Special features for precise repetitive dispensing include anti-drip. Precise PWM speed control. Quiet operation. Tachometer feedback for ±0.1% speed control. Pump heads can be stacked. Benchtop or washdown wall-mount controller. Calibration capability. Programmable for all L/S tubing sizes.	90–91
<b>DIGITAL PROCESS</b>							
	Lowest: 0.006 Highest: 3400	—	0.1 to 600	✓	Speed, direction, start/stop, prime	Four-line graphical LCD with menu-driven programming. IP66 and NEMA 4X rated for washdown. Sealed housing. Maintenance-free brushless motor with PWM speed control. Dispensing features include delay interval and cumulative volume. Full remote control capability.	92–93
<b>DIGI-STALTIC® DISPENSER</b>							
	Lowest: 0.72 Highest: 5800	—	6 to 600	✓	Start/stop	Control multiple Digi-Staltic drives from a single controller. Controller stores up to 30 programs. Ideal for automated process applications. Stack pump heads.	98–99

Digital

## L/S® FIXED-SPEED DRIVES

### FEATURES/BENEFITS

- ▶ Flow rates: 0.06 to 290 mL/min depending on drive model and tubing size
- ▶ Simple, economical pump drives for general, intermittent-duty fluid transfer applications
- ▶ Lighted power switch on front of drive lets you know that pump is running
- ▶ Seven speeds available—choose speed and tubing size to achieve your desired flow rate(s)
- ▶ Drives are UL, cUL listed and CE compliant
- ▶ Ideal as an acid/base or nutrient feed pump in fermentation applications
- ▶ Housing is stackable for efficient use of limited space

### DRIVE CONTROLS

- ▶ Use lighted power switch on front of drive to turn drive on/off

### SETUP

1. Mount pump head(s) onto drive.
2. Select tubing size required to deliver desired flow rate; load tubing in pump head.
3. Turn pump on.

### SPEED CONTROL/CIRCUITRY

- ▶ Fixed-speed drives; no speed control
- ▶ Drive speed may vary  $\pm 15\%$  depending on line voltage/frequency fluctuations
- ▶ 115 VAC: UL778, CSA C22.2 No. 108-01; 230 VAC For CE mark: EN61010-1 (EU Low Voltage) and EN61326 (EU EMC)

### PUMP HEADS ACCEPTED

- ▶ Accept five different types of L/S pump heads: Standard, Easy-Load® 3, Easy-Load® II, Easy-Load®, and multichannel cartridge

**Note:** The 60-rpm drives accept only one pump head and should not be used with multichannel or multichannel cartridge pump heads.

L/S fixed-speed drive 07540-01 shown with Easy-Load II pump head 77200-62



L/S fixed-speed drive 07540-12 shown with Standard pump head 07015-21



ISO9001:2008  
CERTIFIED SUPPLIER



2 year warranty

### ORDERING INFORMATION

Catalog number			
rpm†	115 VAC, 60 Hz	rpm†	230 VAC, 50 Hz
1	<a href="#">HL-07540-01</a>	1	<a href="#">HL-07542-01</a>
2	<a href="#">HL-07540-02</a>	2	<a href="#">HL-07542-02</a>
6	<a href="#">HL-07540-06</a>	5	<a href="#">HL-07542-06</a>
12	<a href="#">HL-07540-12</a>	10	<a href="#">HL-07542-12</a>
20	<a href="#">HL-07540-20</a>	17	<a href="#">HL-07542-20</a>
30	<a href="#">HL-07540-30</a>	25	<a href="#">HL-07542-30</a>
60	<a href="#">HL-07540-60</a>	50	<a href="#">HL-07542-60</a>

†Drive speed may vary  $\pm 15\%$  depending on fluctuations in line voltage and frequency.

### L/S PUMP TUBING FLOW RATE INFORMATION (mL/min)†

Order Masterflex L/S pump tubing separately on pages 68–73.

Tubing cross sections	L/S Precision pump tubing						L/S High-performance Precision pump tubing			
	L/S 13	L/S 14	L/S 16	L/S 25	L/S 17	L/S 18	L/S 15	L/S 24	L/S 35	L/S 36
Flow rate @ 1 rpm	0.06	0.21	0.8	1.7	2.8	3.8	1.7	2.8	3.8	4.8
Flow rate @ 2 rpm	0.12	0.42	1.6	3.4	5.6	7.6	3.4	5.6	7.6	9.6
Flow rate @ 6 rpm	0.36	1.3	4.8	10	17	23	10	17	23	29
Flow rate @ 12 rpm	0.72	2.5	9.6	20	34	46	20	34	46	58
Flow rate @ 20 rpm	1.2	4.2	16	34	56	76	34	56	76	96
Flow rate @ 30 rpm	1.8	6.3	24	50	84	110	50	84	110	140
Flow rate @ 60 rpm	3.6	13	48	100	170	230	100	170	230	290

†Motor rpm and flow rates for the 230 VAC, 50 Hz drives are approximately 5% of the values shown.



## SPECIFICATIONS for L/S Fixed-Speed Drives

Catalog number	<a href="#">HL-07540-01, -02, -06, -12, -20, -30, -60</a>	<a href="#">HL-07542-01, -02, -06, -12, -20, -30, -60</a>
<b>Performance Specifications</b>		
Flow capacity	0.06 to 290 mL/min (0 to 4.6 GPH)	
Fixed rpm <sup>††</sup>	1, 2, 6, 12, 20, 30, 60	
Number of heads accepted	2 (1 on 60 rpm)	
Maximum torque – running	127 N-cm (180 oz-in) for 1, 2, 6, 12, 20, 30 rpm 64 N-cm (90 oz-in) for 60 rpm	
Reversible	No <sup>††</sup>	
External control – Input	Not applicable	
External control – Output		
<b>Electrical Specifications</b>		
Voltage/Frequency VAC (Hz)	115 (60)	230 (50)
Current	0.3 A for 1, 2 rpm; 0.5 A for 6, 12 rpm; 0.6 A for 20 rpm; 0.9 A for 30, 60 rpm	
Motor type	AC shaded pole	
Motor size	Sub-fractional <sup>†††</sup>	
Motor/speed control type	Not applicable	
Speed regulation (repeatability)	±8% (±8%)	
Soft start/Electronic brake	None	
<b>Physical Specifications</b>		
Housing materials	Painted steel housing	
IP rating <sup>†††</sup>	IP22	
Agency listings	UL, cUL, CE	
Storage temperature	-25 to 65°C (-13 to 149°F)	
Operating temperature	0 to 40°C (32 to 104°F)	
Dimensions (L x W x H)	15.2 x 13.4 x 11.9 cm (6" x 5¼" x 4¾")	
Shipping weight	2.9 kg (6.3 lb)	

<sup>††</sup>Drive speed may vary ±15% depending on fluctuations in line voltage and frequency.

<sup>††</sup>All nonreversible drives turn CW as viewed from front.





<sup>†††</sup>Maximum power required is 70 W or less for indicated models.

<sup>†††</sup>See page 194 for an explanation of IP ratings.

## ACCESSORIES

**HL-08670-02 Start/stop foot switch**  
for all 115 VAC drives; 1.8-m (6-ft) cable.

**HL-17050-01 NIST-traceable calibration**  
for peristaltic pump drive.

<p><b>STANDARD</b> 0.06 to 2900 mL/min pages 40–41</p>		<p><b>MULTICHANNEL CARTRIDGE</b> 3- or 4-roller; up to 8 channels 0.047 to 1700 mL/min pages 56–57</p>	
<p><b>EASY-LOAD® 3</b> 0.06 to 2900 mL/min pages 42–43</p>		<p>6- or 8-roller; up to 12 channels 0.0005 to 350 mL/min pages 58–59</p>	
<p><b>EASY-LOAD® II</b> 0.06 to 2900 mL/min pages 44–45</p>			
<p><b>EASY-LOAD®</b> 0.06 to 2300 mL/min pages 46–47</p>			

**Dimensional Drawings cm (in.)**  
07540-, 07542-series

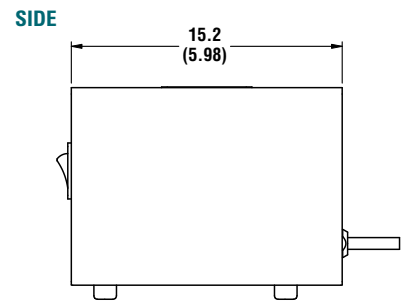
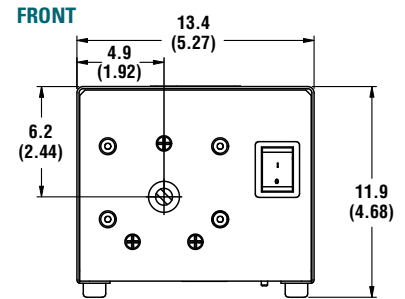

## FREE TUBING TEST KIT!

**Can't find your chemical in the tables?**

Request your FREE tubing kit to test compatibility of your chemicals against different tubing formulations. Request item HL-00101-10.

**Call or go online to request your FREE test kit today!**



L/S® PUMP HEADS.....	<b>38–67</b>
L/S® TUBING .....	<b>68–73</b>
L/S® PUMP SYSTEMS .....	<b>108–117</b>

ACCESSORIES.....	<b>160–171</b>
------------------	----------------

TECHNICAL DATA.....	<b>172–206</b>
---------------------	----------------

## L/S® COMPACT VARIABLE-SPEED PUMPS

### FEATURES/BENEFITS

- ▶ Flow rates: 0.8 to 105 mL/min depending on drive model and tubing size
- ▶ Single- or dual-channel models; dual-channel model delivers synchronous flow from two separate channels
- ▶ Integral pump head accepts L/S two-stop pump tubing sets
- ▶ Tubing sets are easy to load with no occlusion or retention adjustment
- ▶ Separate single-turn speed control and CW/OFF/CCW switch—maintain speed setting when turning pump on/off
- ▶ Potentiometer is indexed for repeatability
- ▶ Remote start/stop via contact closure on back of pump
- ▶ Self-lubricating, thermoplastic polyester (Ertalyte® TX) rollers are low friction for smooth operation and long life
- ▶ Durable, anodized aluminum occlusion bed swings open for loading; locks securely shut during operation
- ▶ Three rollers and wide occlusion angle prevent fluid backflow up to rated pressure of tubing
- ▶ Painted-steel housing is stackable—ideal for crowded benchtops
- ▶ Powered by remote, dual-voltage (115/230 VAC) power supply

### DRIVE CONTROLS

- ▶ All manual controls are on the front panel of pump
- ▶ Separate CW/OFF/CCW with green LED power indicator
- ▶ Single-turn potentiometer speed control
- ▶ MAX button runs pump at full speed to prime or flush tubing

### SETUP

1. Select and load tubing.
2. Select motor direction (CW/CCW).
3. Turn pump on.
4. Adjust flow rate and speed with indexed, single-turn potentiometer.



L/S single-channel compact pump 77240-00



L/S dual-channel compact pump 77240-10

### SPEED CONTROL/CIRCUITRY

- ▶ Single-turn potentiometer
- ▶ Speed control (repeatability): ±5%
- ▶ Meets UL 508C, CSA C22.2, No. 14, EN61010-1 and EN61326-1 (for CE mark)

### REMOTE CONTROL

- ▶ Remote start/stop via contact closure

### PUMP HEADS ACCEPTED

- ▶ These compact pumps include an integral single- or dual-channel pump head



### ORDERING INFORMATION

Catalog number	No. of channels	rpm	Power (50/60 Hz)
<a href="#">HL-77240-00</a>	1	20 to 100	115/230 VAC, dual voltage
<a href="#">HL-77240-10</a>	2		

### ACCESSORIES

[HL-77200-07](#) Replacement power supply, dual-voltage 115/230 VAC.

[HL-17050-01](#) NIST-traceable calibration for peristaltic pump drive.

### L/S TWO-STOP PUMP TUBING SET FLOW RATE INFORMATION (mL/MIN)

Order Masterflex L/S two-stop tubing sets separately on page 79; order L/S extension tubing on pages 68–73.

Pump model	Motor rpm range	L/S Precision pump tubing			
<a href="#">HL-77240-00</a>	20 to 100	0.8 to 40	2.8 to 14	11 to 54	21 to 105
<a href="#">HL-77240-10</a>		0.8 to 40	2.8 to 14	Not recommended	Not recommended

Note: All flow rates are approximate—calculated under the following conditions: 0 bar (0 psig) at inlet, 0.03 bar (0.5 psig) at outlet; water temperature at 22°C (72°F).





### SPECIFICATIONS for L/S Compact Variable-Speed Pumps

Catalog number		HL-77240-00	HL-77240-10
<b>Performance Specifications</b>			
Flow capacity (per channel)	0.8 to 105 mL/min (0 to 1.66 GPH)	0.8 to 14 mL/min (0 to 0.22 GPH)	
Number of channels	1	2	
rpm	20 to 100		
Number of heads accepted	Integral single-channel head	Integral dual-channel head	
Maximum torque	Starting	113 N-cm (160 oz-in)	
	Running	35 N-cm (50 oz-in)	
Reversible	Yes (three-position switch for CW/OFF/CCW)		
External control – Input	Start/stop via contact closure		
External control – Output	Not applicable		
<b>Electrical Specifications</b>			
Voltage/Frequency VAC (50/60 Hz)	90 to 130 and 190 to 260 dual-voltage (13.5 VDC nominal)		
Current	0.5 A at 115 V; 0.3 A at 230 V		
Motor type	Permanent-magnet brushed DC		
Motor size	6 W		
Motor/speed control type	Single-turn potentiometer		
Speed regulation (repeatability)	±5%		
Soft start/Electronic brake	Yes/No		
<b>Physical Specifications</b>			
Housing materials	Painted steel		
IP rating†	IP22		
Agency listings	UL, cUL, CE		
Operating temperature	0 to 40°C (32 to 104°F)		
Storage temperature	–25 to 65°C (–13 to 149°F)		
Dimensions (L x W x H)	16.5 x 13.3 x 11.4 cm (6½" x 5¼" x 4½")		
Shipping weight	2.7 kg (6 lb)		

†See page 194 for an explanation of IP ratings.

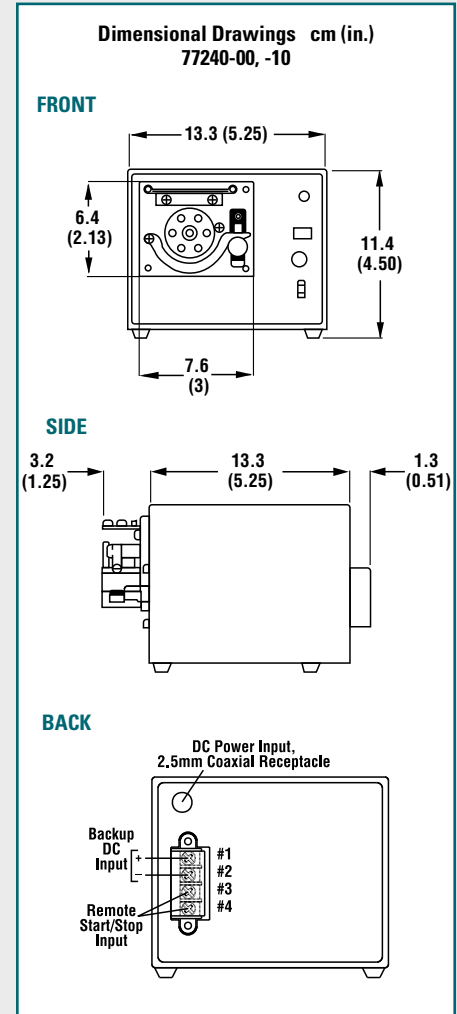

### HOW TO LOAD YOUR PUMP HEAD



1. Release occlusion bed latch and open occlusion bed.



2. Hook left-side tubing stop to the top of the left-side retainer slot. Stretch tubing around rollers and hook right-side stop to the top of the right-side retainer slot.



3. Lift occlusion bed and close latch; locking occlusion bed in place.

L/S<sup>®</sup> TUBING ..... 68–73

L/S<sup>®</sup> PUMP SYSTEMS ..... 108–117

ACCESSORIES ..... 160–171

TECHNICAL DATA ..... 172–206

### L/S TWO-STOP PRECISION PUMP TUBING SETS ORDERING INFORMATION

Tubing size	Tygon <sup>®</sup> E-LFL	Platinum-cured silicone	BioPharm Plus Silicone (platinum-cured)	PharMed <sup>®</sup> BPT	Viton <sup>®</sup>	Chem-Durance <sup>®</sup> Bio
	<b>NEW</b>					
L/S 13	<a href="#">HL-06447-13</a>	<a href="#">HL-06421-13</a>	<a href="#">HL-96116-13</a>	<a href="#">HL-96114-13</a>	<a href="#">HL-96428-13</a>	<a href="#">HL-96117-13</a>
L/S 14	<a href="#">HL-06447-14</a>	<a href="#">HL-06421-14</a>	<a href="#">HL-96116-14</a>	<a href="#">HL-96114-14</a>	<a href="#">HL-96428-14</a>	<a href="#">HL-96117-14</a>
L/S 16	<a href="#">HL-06447-16</a>	<a href="#">HL-06421-16</a>	<a href="#">HL-96116-16</a>	<a href="#">HL-96114-16</a>	<a href="#">HL-96428-16</a>	<a href="#">HL-96117-16</a>
L/S 25	<a href="#">HL-06447-25</a>	<a href="#">HL-06421-25</a>	<a href="#">HL-96116-25</a>	<a href="#">HL-96114-25</a>	<a href="#">HL-96428-25</a>	<a href="#">HL-96117-25</a>
Qty/pk	8	8	8	8	8	8

## L/S® COMPACT, LOW-FLOW, VARIABLE-SPEED DRIVES

### FEATURES/BENEFITS

- ▶ Deliver flow rates from 2.1 to 560 mL/min (0.03 to 8.8 GPH) with Masterflex® L/S pump head†
- ▶ Ideal for smaller work spaces
- ▶ Compact size: 13.6 x 13.3 x 11.4 cm (5<sup>3</sup>/<sub>8</sub>" x 5<sup>1</sup>/<sub>16</sub>" x 4<sup>1</sup>/<sub>2</sub>" )
- ▶ Stackable, painted-steel housing
- ▶ Economically priced
- ▶ Housing protects drive from vertically falling water
- ▶ Reversible permanent-magnet DC motor
- ▶ Purge before or after pumping; pump in either direction
- ▶ Remote control capabilities
- ▶ IP22 enclosure rating per IEC

### DRIVE CONTROLS

- ▶ All manual controls are on the front panel of drive
- ▶ Separate CW/OFF/CCW switch with green power indicator
- ▶ Single-turn potentiometer speed control
- ▶ MAX button facilitates priming or flushing at maximum rpm

### SETUP

1. Mount pump head.
2. Load tubing.
3. Select motor direction (CW/CCW).
4. Turn pump on.
5. Adjust flow rate with the one-turn potentiometer speed control.

### SPEED CONTROL/CIRCUITRY

- ▶ Single-turn potentiometer
- ▶ Speed control (repeatability): ±5%
- ▶ Meets UL508C, CSA C22.2, No. 14; for CE mark EN61010-1 and EN61326-1 (EU EMC)

### REMOTE CONTROL

- ▶ Remote start/stop via contact closure

### PUMP HEADS ACCEPTED

- ▶ Drive accepts two different types of pump heads—Standard or Easy-Load®
- ▶ No pump head stacking capability

†Depending on drive rpm and tubing size.



L/S compact drive 77200-20 shown with Standard pump head 07016-21



Power supply is:



### ORDERING INFORMATION

Catalog number	rpm	Power (50/60 Hz)
<a href="#">HL-77200-20</a>	35 to 200	115/230 VAC
<a href="#">HL-77200-12</a>		12 VDC

### ACCESSORIES

[HL-77200-07](#) Replacement power supply, dual-voltage 115/230 VAC.

[HL-17050-01](#) NIST-traceable calibration for peristaltic pump drive.



Compact variable-speed drives accept a single pump head—either Standard or Easy-Load®.

### L/S PUMP TUBING FLOW RATE INFORMATION (mL/MIN)

Order Masterflex L/S pump tubing separately on pages 68–73.

Tubing cross sections	L/S Precision pump tubing				
	L/S 13	L/S 14	L/S 16	L/S 25 <sup>‡</sup>	L/S 17 <sup>‡</sup>
Flow range @ 35 to 200 rpm	2.1 to 12	7.4 to 42	28 to 160	60 to 340	98 to 560

<sup>‡</sup>C-FLEX® and silicone tubing formulations are recommended for L/S 17 and L/S 25 size tubing.

Note: All flow rates are approximate—calculated under the following conditions: 0 bar (0 psig) at inlet, 0.03 bar (0.5 psig) at outlet; water temperature at 22°C (72°F).

STANDARD  
2.1 to 560 mL/min  
pages 40–41



EASY-LOAD®  
2.1 to 560 mL/min  
pages 46–47

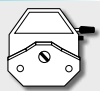

### SPECIFICATIONS for L/S Compact, Low-Flow, Variable-Speed Drives

Catalog number	<a href="#">HL-77200-20</a>	<a href="#">HL-77200-12</a>
<b>Performance Specifications</b>		
Flow capacity	2.1 to 560 mL/min (0.03 to 8.8 GPH) <sup>†</sup>	
rpm	35 to 200	
Number of heads accepted	1	
Maximum torque	Starting	56 N-cm (80 oz-in)
	Running	18 N-cm (25 oz-in)
Reversible	Yes (three-position switch for CW/OFF/CCW)	
External control – Input	START/STOP via contact closure	
External control – Output	Not applicable	
<b>Electrical Specifications</b>		
Voltage/Frequency	90 to 260 VAC (50/60 Hz)	13.5 VDC nominal
Current	120 mA @ 115 V; 60 mA @ 230 V (AC)	2.4 A (DC)
Motor type	Permanent magnet DC	
Motor size	6 W	
Motor/speed control type	Single-turn potentiometer	
Speed regulation (repeatability)	±5% (5% of max rpm)	
Soft start/Electronic brake	Yes (remote)/No	
<b>Physical Specifications</b>		
Housing materials	Painted steel	
IP rating <sup>‡</sup>	IP22	
Agency listings	CE, Power supply: UL, cUL	—
Storage temperature	–25 to 65°C (–13 to 149°F)	
Operating temperature	0 to 40°C (32 to 104°F)	
Humidity	10 to 90% (noncondensing)	
Dimensions (L x W x H)	13.6 x 13.3 x 11.4 cm (5 3/8" x 5 1/4" x 4 1/2")	
Shipping weight	1.7 kg (3.7 lb)	

<sup>†</sup>Depending on drive rpm and tubing size selected.

<sup>‡</sup>See page 194 for an explanation of IP ratings.



Drives are stackable—ideal where space is limited.

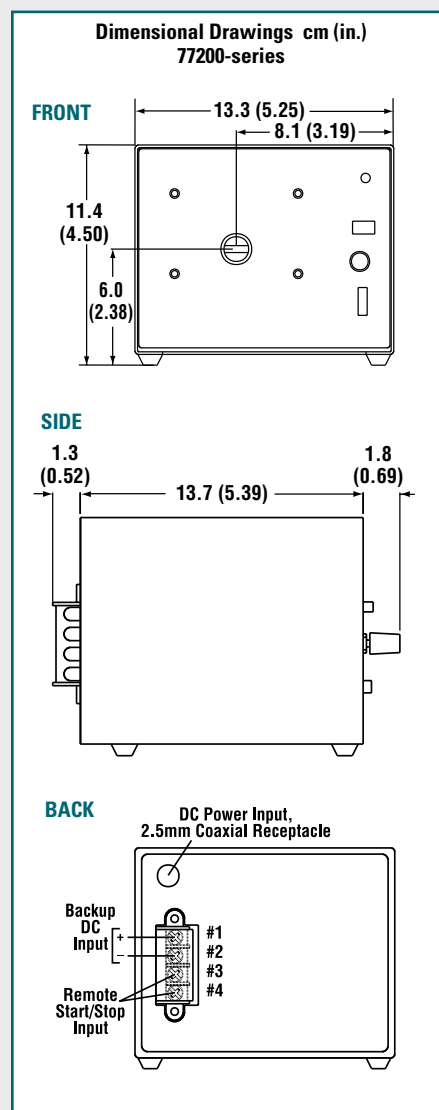

### FOR THE LATEST...

Masterflex technical resources, see

- [ColeParmer.com](#)
- [Masterflex.com](#)

L/S® PUMP HEADS..... 38–67  
L/S® TUBING ..... 68–73  
L/S® PUMP SYSTEMS ..... 108–117

ACCESSORIES ..... 160–171

TECHNICAL DATA..... 172–206

## L/S® VARIABLE-SPEED ECONOMY DRIVES

### FEATURES/BENEFITS

- ▶ Perfect upgrade from a fixed-speed drive to a variable-speed system
- ▶ Deliver flow rates from 0.42 to 2900 mL/min with Masterflex® L/S pump heads
- ▶ Deliver flow rates from 0.0035 to 1700 mL/min with cartridge pump heads
- ▶ Wide flow control range (30:1 turndown)
- ▶ Long-lasting, stackable steel housing
- ▶ Ideal for low-flow metering or general fluid transfer
- ▶ Safe, reliable continuous-duty motor
- ▶ Unidirectional operation
- ▶ Multichannel pumping

### DRIVE CONTROLS

- ▶ All manual controls are on the front panel
- ▶ Single-turn potentiometer for speed control
- ▶ On/off switch, green power-on indicator

### SETUP

1. Mount pump head and load tubing.
2. Turn pump on.
3. Adjust flow rate with potentiometer.

### SELECTION CRITERIA

1. Motor rpm/flow rate.
2. Voltage required.
3. Pump heads accepted.

**Order pump heads and tubing separately.**

### SPEED CONTROL/CIRCUITRY

- ▶ Single-turn potentiometer
- ▶ Solid-state circuit
- ▶ Soft-start for no power surges
- ▶ Speed not affected by minimum variations in line voltage or frequency
- ▶ Switch: ON/OFF
- ▶ Meets or exceeds UL, CSA, EN, and selected IEC limits



L/S variable-speed console drive 07554-90 with L/S Easy-Load pump head 07518-12

### MOTOR SPECIFICATIONS

- ▶ Permanently lubricated
- ▶ Designed around a 90 or 180 VDC motor

### PUMP HEADS ACCEPTED

- ▶ Drive accepts nine different pump heads:
 

Standard	High-Performance
Easy-Load® 3	PTFE-Tubing
Easy-Load II	Multichannel
Easy-Load	Multichannel Cartridge
PTFE-Diaphragm	

### NOTES

Use drives 07554-90 and 07554-95 with High-Performance, Multichannel, and Cartridge pump heads only when loaded with C-FLEX® or silicone tubing. Do not use these 600-rpm drives with the PTFE-tubing or PTFE-diaphragm pump heads.

ISO9001:2008  
CERTIFIED SUPPLIER

cULus

CE

2 year  
warranty

### ORDERING INFORMATION

Catalog number	rpm	Power (50/60 Hz)
<a href="#">HL-07554-90</a>	20 to 600	90 to 130 VAC
<a href="#">HL-07554-95</a>		180 to 260 VAC
<a href="#">HL-07554-80</a>	7 to 200	90 to 130 VAC
<a href="#">HL-07554-85</a>		180 to 260 VAC

### ACCESSORIES

[HL-17050-01](#) NIST-traceable calibration for peristaltic pump drive.

### SEE PAGES 108-117

For complete L/S pump systems.



77910-30

### L/S PUMP TUBING FLOW RATE INFORMATION (mL/min)

Order Masterflex L/S pump tubing separately on pages 68-73.

Tubing cross sections	L/S Precision pump tubing						L/S High-performance Precision pump tubing			
	L/S 13	L/S 14	L/S 16	L/S 25	L/S 17	L/S 18	L/S 15	L/S 24	L/S 35	L/S 36
Flow range @ 20 to 600 rpm	1.2 to 36	4.2 to 130	16 to 480	34 to 1000	56 to 1700	76 to 2300	34 to 1000	56 to 1700	76 to 2300	96 to 2900
Flow range @ 7 to 200 rpm	0.42 to 12	1.4 to 43	5.6 to 160	12 to 330	20 to 570	27 to 770	12 to 330 (13 to 370)	20 to 570 (21 to 600)	27 to 770 (30 to 870)	34 to 970 (41 to 1130)

Note: Flow rates in parentheses can be obtained only with L/S High-Performance pump heads.

### SPECIFICATIONS for L/S Variable-Speed Economy Drives

Catalog number	<a href="#">HL-07554-90</a>	<a href="#">HL-07554-95</a>	<a href="#">HL-07554-80</a>	<a href="#">HL-07554-85</a>
<b>Performance Specifications</b>				
Flow capacity	1.2 to 2900 mL/min (0 to 46 GPH)		0.42 to 970 mL/min (0 to 15 GPH)	
rpm	20 to 600		7 to 200	
Number of heads accepted	1		2	
Maximum torque	Starting	191 N-cm (270 oz-in)	381 N-cm (540 oz-in)	
	Running	64 N-cm (90 oz-in)	127 N-cm (180 oz-in)	
Reversible	No			
External control – Input	Not applicable			
External control – Output	Not applicable			
<b>Electrical Specifications</b>				
Voltage/frequency VAC (50/60 Hz)	90 to 130	180 to 260	90 to 130	180 to 260
Current	1.5 A	0.8 A	1.5 A	0.8 A
Fuse rating	2.0 A / 250 V	1.0 A / 250 V	2.0 A / 250 V	1.0 A / 250 V
Motor type	Continuous-duty, permanent magnet DC			
Motor size	37 W (½ hp)			
Motor/speed control type	Single-turn potentiometer, solid-state			
Speed regulation (repeatability)	±5% (±3%)			
Soft start/Electronic brake	Yes/No			
<b>Physical Specifications</b>				
Housing materials	Painted steel			
IP rating	IP22†			
Agency listings	UL, cUL, CE			
Operating temperature	0 to 40°C (32 to 104°F)			
Storage temperature	–25 to 65°C (–13 to 149°F)			
Dimensions (L x W x H)	22.9 x 18.1 x 13.3 cm (9" x 7 1/8" x 5 1/4")			
Shipping weight	3.7 kg (8 lb)			

†See page 194 for an explanation of IP ratings.

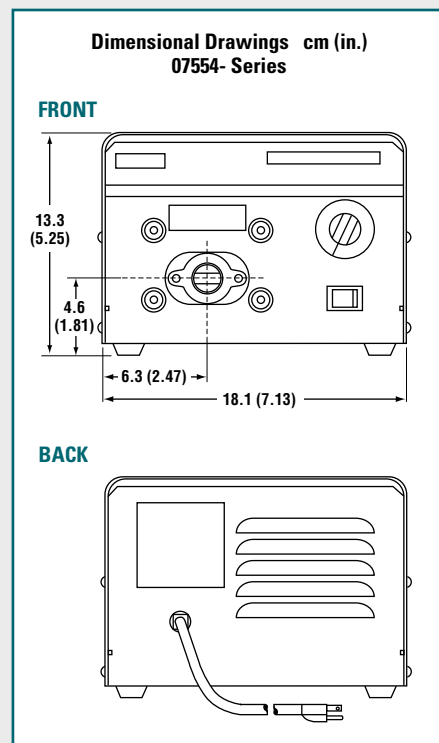

### 24-HOUR PROTECTION

The Liqui-Sense® emergency cut-off system protects you from pumping problems 24 hours a day. Detection of a leak or a high/low liquid level in a tank signals the Liqui-Sense controller to turn off your pump and turn on a back-up. Please see pages 160–161 for a complete description.



### MORE INFO

Request your FREE Masterflex Tubing Test Kit to test compatibility of your chemicals against different tubing formulations. Request item HL-00101-10.

**Call today!**



<p><b>STANDARD</b> 0.42 to 2900 mL/min pages 40–41</p>	<p><b>HIGH-PERFORMANCE</b> 12 to 3400 mL/min pages 48–49</p>	<p><b>MULTICHANNEL CARTRIDGE</b> 3- or 4-roller; up to 8 channels 0.33 to 1700 mL/min pages 56–57</p>
<p><b>EASY-LOAD® 3</b> 0.42 to 2900 mL/min pages 42–43</p>	<p><b>PTFE-TUBING</b> 0.42 to 65 mL/min pages 50–51</p>	<p>6- or 8-roller; up to 12 channels 0.0035 to 350 mL/min pages 58–59</p>
<p><b>EASY-LOAD® II</b> 0.42 to 2900 mL/min pages 44–45</p>	<p><b>MULTICHANNEL</b> 4- or 8-channel for microbore tubing 0.02 to 200 mL/min pages 52–53</p>	<p><b>PTFE-DIAPHRAGM</b> 10 to 800 mL/min pages 60–61</p>
<p><b>EASY-LOAD®</b> 0.42 to 2300 mL/min pages 46–47</p>	<p>2-, 4-, or 8-channel for L/S® Precision tubing 0.32 to 2300 mL/min pages 54–55</p>	

L/S® PUMP HEADS.....38–67  
L/S® TUBING .....68–73  
L/S® PUMP SYSTEMS .....108–117

ACCESSORIES.....160–171

TECHNICAL DATA.....172–206

## L/S® VARIABLE-SPEED ANALOG CONSOLE DRIVES

### FEATURES/BENEFITS

- ▶ Flow rates: 0.06 to 3400 mL/min (0.001 to 54 GPH) with L/S tubing
- ▶ Cartridge flow rate: 0.0005 to 1700 mL/min per channel
- ▶ Three-digit LED shows motor speed (rpm)
- ▶ PWM speed control for precise, efficient control; ±0.25% speed control accuracy
- ▶ Reversible motor—easily reverse direction of flow
- ▶ Stackable housing is IP33 rated for wipedown
- ▶ Universal voltage, 90 to 260 VAC autoselect, 50/60 Hz
- ▶ Compatible with all L/S pump heads

### DRIVE CONTROLS

- ▶ Protected power switch located on back of drive
- ▶ Lighted display indicates power is on
- ▶ LED indicator shows motor/pumping direction
- ▶ Simple programming and operation of the following via sealed membrane keypad:
  - ◆ Flow direction
  - ◆ Motor speed (rpm)
  - ◆ Control mode (remote/internal)
  - ◆ Start/stop

### SETUP

1. Mount pump head(s) and load tubing.
2. Turn drive power on.
3. Select manual (internal) or remote (external) control.
4. Select motor direction.
5. Set drive speed (rpm) through keypad.
6. Press START key to begin pumping.



07528-10

### SPEED CONTROL/CIRCUITRY

- ▶ Regulate motor through keypad, 4 to 20 mA, or 0 to 10 V signal
- ▶ Soft start for starts without power surges
- ▶ Speed not affected by variations in power line voltage (VAC) and frequency (Hz)
- ▶ Line filters reduce outside interference
- ▶ Meets UL 61010-1, CSA C22.2, No. 61010-1; For CE mark: EN61010-1 (EU low voltage) and EN61326-1 (EU EMC)

### REMOTE CONTROL

- ▶ Speed control input: 4 to 20 mA, and 0 to 10 V
- ▶ START/STOP, CW/CCW via contact closure
- ▶ 9-pin (DB9) female connection
- ▶ Handheld remote and foot switch options; order separately under "Accessories"

### KEYPAD LOCK/UNLOCK FEATURE

- ▶ Lock out keypad and protect settings with special key sequence

### ORDERING INFORMATION



Catalog number	rpm	Power (50/60 Hz)
<a href="#">HL-07528-10</a>	6 to 600	90 to 260 VAC
<a href="#">HL-07528-20</a>	3 to 300	
<a href="#">HL-07528-30</a>	1 to 100	

### ACCESSORIES

[HL-17050-01](#) NIST-traceable calibration for peristaltic pump drive.

### L/S PUMP TUBING FLOW RATE INFORMATION (mL/MIN)

Order Masterflex L/S pump tubing separately on pages 68–73.

Tubing cross sections	L/S Precision pump tubing						L/S High-performance Precision pump tubing			
	L/S 13	L/S 14	L/S 16	L/S 25	L/S 17	L/S 18	L/S 15	L/S 24	L/S 35	L/S 36
Flow range @ 6 to 600 rpm	0.36 to 36	1.3 to 130	4.8 to 480	10 to 1000	17 to 1700	23 to 2300	10 to 1000 (11 to 1100)	17 to 1700 (18 to 1800)	23 to 2300 (26 to 2600)	29 to 2900 (34 to 3400)
Flow range @ 3 to 300 rpm	0.18 to 18	0.65 to 65	2.4 to 240	5 to 500	8.5 to 850	11.5 to 1150	5 to 500 (5.5 to 550)	8.5 to 850 (9 to 900)	11.5 to 1150 (13 to 1300)	14.5 to 1450 (17 to 1700)
Flow range @ 1 to 100 rpm	0.06 to 6	0.21 to 21	0.8 to 80	1.7 to 170	2.8 to 280	3.8 to 380	1.7 to 170 (1.8 to 180)	2.8 to 280 (3.0 to 300)	3.8 to 380 (4.3 to 430)	4.8 to 480 (5.8 to 580)

**Note:** Flow rates were determined using water at room temperature and with zero back pressure and zero suction lift. Higher flow rates in parentheses can be obtained only with L/S High-Performance pump heads.



### SPECIFICATIONS for L/S Variable-Speed Analog Console Drives

Catalog number	HL-07528-10	HL-07528-20	HL-07528-30
<b>Performance Specifications</b>			
Flow capacity	0.36 to 3400 mL/min (0 to 54 GPH)	0.18 to 1700 mL/min (0 to 27 GPH)	0.06 to 580 mL/min (0 to 9 GPH)
rpm	6 to 600	3 to 300	1 to 100
Number of heads accepted	2	2	4
Maximum torque	Starting	381 N-cm (540 oz-in)	763 N-cm (1080 oz-in)
	Running	127 N-cm (180 oz-in)	254 N-cm (360 oz-in)
Reversible	Yes		
External control – Input	4 to 20 mA, 0 to 10 V; START/STOP; CW/CCW via contact closure		
External control – Output	Not applicable		
<b>Electrical Specifications</b>			
Voltage/Frequency VAC (Hz)	90 to 260 (50/60)		
Current	2.2 A at 115 V; 1.1 A at 230 V		
Fuse rating	3.15 A / 250 V		
Motor type†	Continuous duty, TENV†, permanent-magnet DC		
Motor size	75 W (1/10 hp)		
Display	Three-digit LED		
Motor/speed control type	PWM		
Speed regulation	±0.25%		
Soft start/Electronic brake	Yes/No		
<b>Physical Specifications</b>			
Housing materials	Stackable ABS plastic housing/coated aluminum chassis		
IP rating‡	IP33		
Agency listings	ETL, cETL, CE		
Operating temperature	0 to 40°C (32 to 104°F)		
Storage temperature	–25 to 65°C (–13 to 149°F)		
Dimensions (L x W x H)	27.4 x 21.2 x 21.6 cm (10¾" x 8¼" x 8½")		
Shipping weight	6.9 kg (15.2 lb)		

†TENV—totally enclosed, nonventilating.  
‡See page 194 for an explanation of IP ratings.

### ACCESSORIES

- HL-77595-35 Foot switch**, momentary start/stop; 1.8-m (6-ft) cable.
- HL-07595-45 DB9 male connector**, use to create your own cable.
- HL-07595-47 Cable assembly**, DB9 male connector and 7.9 m (25-ft) cable with stripped wire terminal ends. Use for remote control.
- HL-07523-98 Tilt bail**; use to securely elevate front of drive.
- HL-07528-80 Handheld remote controller**, DB9 male; for on/off control; route tubing through handle for filling and dispensing applications.



### Dimensional Drawings cm (in.) 07528-series

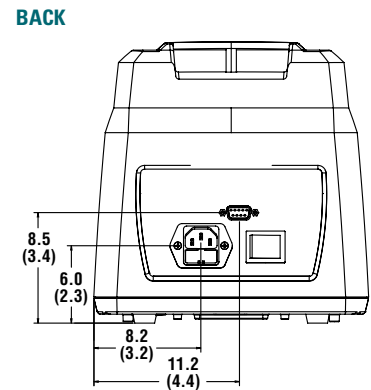
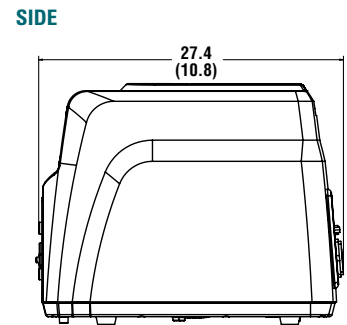
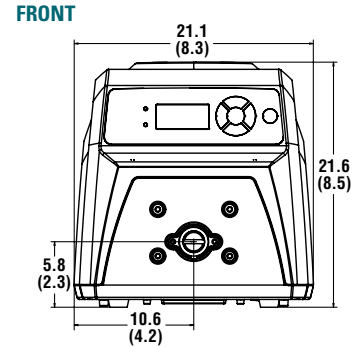

<p><b>STANDARD</b> 0.06 to 2900 mL/min pages 40–41</p>	<p><b>HIGH-PERFORMANCE</b> 0.9 to 3400 mL/min pages 48–49</p>	<p><b>MULTICHANNEL CARTRIDGE</b> 3- or 4-roller; up to 8 channels 0.047 to 1700 mL/min pages 56–57</p>
<p><b>EASY-LOAD® 3</b> 0.06 to 2900 mL/min pages 42–43</p>	<p><b>PTFE-TUBING</b> 0.06 to 65 mL/min pages 50–51</p>	<p>6- or 8-roller; up to 12 channels 0.0005 to 350 mL/min pages 58–59</p>
<p><b>EASY-LOAD® II</b> 0.06 to 2900 mL/min pages 44–45</p>	<p><b>MULTICHANNEL</b> 4- or 8-channel for microbore tubing 0.0026 to 200 mL/min pages 52–53</p>	<p><b>PTFE-DIAPHRAGM</b> 10 to 800 mL/min pages 60–61</p>
<p><b>EASY-LOAD®</b> 0.06 to 2300 mL/min pages 46–47</p>	<p>2-, 4-, or 8-channel for L/S® Precision tubing 0.045 to 2300 mL/min pages 54–55</p>	

L/S® PUMP HEADS.....	38–67
L/S® TUBING .....	68–73
L/S® PUMP SYSTEMS .....	108–117
ACCESSORIES.....	160–171
TECHNICAL DATA.....	172–206

## L/S® VARIABLE-SPEED PRECISION MODULAR DRIVES

### FEATURES/BENEFITS

- ▶ Flow rates: 0.06 to 3400 mL/min (0.001 to 54 GPH) with L/S tubing
- ▶ Cartridge flow rate: 0.0005 to 1700 mL/min per channel
- ▶ Modular format lets you separate drive and controller for convenient placement; a 1.8-m (6-ft) control cable is included. Extend that distance with optional 2.7-m (9-ft) extension cable
- ▶ Three-digit LED shows motor speed (rpm)—confirm speed setting at a glance
- ▶ PWM speed control for precise, efficient control; ±0.25% speed control accuracy
- ▶ Reversible motor—easily reverse direction of flow to purge or prime tubing
- ▶ Universal voltage, 90 to 260 VAC autoselect, 50/60 Hz
- ▶ Compatible with all L/S pump heads

### DRIVE CONTROLS

- ▶ Protected power switch located on controller
- ▶ Lighted display indicates power is on
- ▶ LED indicator shows motor/pumping direction
- ▶ Simple programming and operation of the following via sealed membrane keypad:
  - ◆ Flow direction
  - ◆ Motor speed (rpm)
  - ◆ Control mode (remote/internal)
  - ◆ Start/stop



Modular drive 07557-60 shown with Easy-Load® II pump head 77200-62



Benchtop modular drive 07557-00

**NEW**

### SETUP

1. Mount pump head(s) and load tubing.
2. Connect drive cable to controller.
3. Turn drive power on.
4. Select manual (internal) or remote (external) control.
5. Select motor direction.
6. Set drive speed (rpm) through keypad.
7. Press START key to begin pumping.

### SPEED CONTROL/CIRCUITRY

- ▶ Regulate motor through keypad, 4 to 20 mA, or 0 to 10 V signal
- ▶ Soft start for starts without power surges
- ▶ Speed not affected by variations in power line voltage (VAC) or frequency (Hz)
- ▶ Line filters reduce outside interference
- ▶ Meets UL 61010-1, CAN/CSA C22.2, No. 61010-1; For CE mark: EN61010-1 (EU low voltage) and EN61326-1 (EU EMC).

### REMOTE CONTROL

#### Benchtop Modular Drives

- ▶ Remote control via 9-pin (DB9) female connection on back of controller
- ▶ Speed control input: 4 to 20 mA, and 0 to 10 V
- ▶ START/STOP, CW/CCW via contact closure
- ▶ Handheld remote, cable, and foot switch options; order separately under "Accessories"

#### Modular Drive with Washdown, Wall-Mount Controller

- ▶ Remote control via 18-pin weather-resistant circular connection on bottom of controller
- ▶ Speed control input: 4 to 20 mA, and 0 to 10 V
- ▶ START/STOP, CW/CCW via contact closure
- ▶ Remote cable and foot switch options; order separately under "Accessories"

### SELECTION CRITERIA

1. Motor rpm / flow rate.
2. Number of pump heads accepted.
3. Benchtop or washdown, wall-mount controller.

Order pump heads and tubing separately.

ISO 9001:2008  
CERTIFIED SUPPLIER

ETL US

CE

07557-60  
and -70

2 year  
warranty

### ORDERING INFORMATION

Catalog number	rpm	Power (50/60 Hz)
<b>Benchtop precision modular drive</b>		
<a href="#">HL-07557-00</a>	6 to 600	90 to 260 VAC
<a href="#">HL-07557-10</a>	1 to 100	
<b>Precision modular drive with washdown controller</b>		
<a href="#">HL-07557-60</a>	6 to 600	90 to 260 VAC
<a href="#">HL-07557-70</a>	1 to 100	

### L/S PUMP TUBING FLOW RATE INFORMATION (mL/MIN)

Order Masterflex L/S pump tubing separately on pages 68–73.

Tubing cross section	L/S Precision pump tubing						L/S High-performance Precision pump tubing			
	L/S 13	L/S 14	L/S 16	L/S 25	L/S 17	L/S 18	L/S 15	L/S 24	L/S 35	L/S 36
Flow range @ 6 to 600 rpm	0.36 to 36	1.3 to 130	4.8 to 480	10 to 1000	17 to 1700	23 to 2300	10 to 1000 (11 to 1100)	17 to 1700 (18 to 1800)	23 to 2300 (26 to 2600)	29 to 2900 (34 to 3400)
Flow range @ 1 to 100 rpm	0.06 to 6	0.21 to 21	0.8 to 80	1.7 to 170	2.8 to 280	3.8 to 380	1.7 to 170 (1.8 to 180)	2.8 to 280 (3.0 to 300)	3.8 to 380 (4.3 to 430)	4.8 to 480 (5.8 to 580)

Note: Flow rates were determined using water at room temperature and with zero back pressure and zero suction lift. Higher flow rates in parentheses can be obtained only with High-Performance pump head.





## SPECIFICATIONS for L/S Variable-Speed Precision Modular Drives

Catalog number	HL-07557-00	HL-07557-10	HL-07557-60	HL-07557-70
<b>Performance Specifications</b>				
Flow capacity	0.36 to 3400 mL/min	0.06 to 580 mL/min	0.36 to 3400 mL/min	0.06 to 580 mL/min
rpm	6 to 600	1 to 100	6 to 600	1 to 100
Number of heads accepted	2	4	2	4
Maximum torque	Starting	381 N·cm (540 oz-in)	763 N·cm (1080 oz-in)	381 N·cm (540 oz-in)
	Running	127 N·cm (180 oz-in)	254 N·cm (360 oz-in)	127 N·cm (180 oz-in)
Reversible	Yes			
External control – Input	4 to 20 mA, 0 to 10 V; START/STOP, CW/CCW via contact closure			
External control – Output	Not applicable			
<b>Electrical Specifications</b>				
Voltage/Frequency VAC (Hz)	90 to 260 (50/60)			
Current	2.2 A at 115 V; 1.1 A at 230 V			
Fuse rating	3.15 A / 250 V			
Motor type	Continuous duty, TENV, permanent magnet DC			
Motor size	75 W (1/10 hp)			
Display	Three-digit LED			
Motor/speed control type	PWM			
Speed regulation	±0.25%			
Soft start/Electronic brake	Yes/No			
<b>Physical Specifications</b>				
Housing materials	Drive	Painted steel and aluminum		Painted steel and aluminum
	Controller	ABS plastic housing, coated aluminum chassis		Painted aluminum
IP rating <sup>†</sup>	IP33		IP66 (NEMA 4X)	
Agency listings	ETL, cETL, CE			
Operating temperature	0 to 40°C (32 to 104°F)			
Storage temperature	-25 to 65°C (-13 to 149°F)			
Dimensions (L x W x H)	Drive	27.7 x 9.7 x 11.7 cm (10 7/8" x 3 3/4" x 4 5/8")		36.2 x 17.8 x 16.5 cm (14 1/4" x 7" x 6 1/2")
	Controller	26.3 x 21.1 x 14.0 cm (10 3/8" x 8 3/8" x 5 1/2")		28.5 x 27.9 x 11.9 cm (10 1/8" x 11" x 4 3/4")
Shipping weight	7.1 kg (15.6 lb)		14.1 kg (31.1 lb)	

<sup>†</sup>See page 194 for an explanation of IP ratings.

## ACCESSORIES

### For Benchtop Models 07557-00, -10

**HL-07557-51 Extension cable**, 2.7 m (9 ft), to extend distance between motor and controller.

**HL-07528-80 Handheld remote controller**; control start/stop and direction; route tubing through handle for dispensing and filling applications; 1.8-m (6-ft) cable.

**HL-07595-47 Cable assembly**, DB9 male connector and 7.9-m (25-ft) cable with stripped wire terminal ends. Use for remote control.

**HL-77595-35 Foot switch**, DB9 male, with 1.8-m (6-ft) cable.

**HL-17050-01 NIST-traceable calibration** with data for peristaltic pump drive.

### For Washdown Models 07557-60, -70

**HL-07557-51 Extension cable**, 2.7 m (9 ft), to extend distance between motor and controller.

**HL-77300-32 Cable assembly**, 18-pin round connector and 7.9-m (25-ft) cable with stripped wire terminal ends. Use for remote control.

**HL-07595-43 Washdown foot switch**, 18-pin round with 1.8-m (6-ft) cable.

**HL-17050-01 NIST-traceable calibration** with data for peristaltic pump drive.

<b>STANDARD</b> 0.06 to 2900 mL/min pages 40–41		<b>HIGH-PERFORMANCE</b> 0.9 to 3400 mL/min pages 48–49		<b>MULTICHANNEL CARTRIDGE</b> 3- or 4-roller; up to 8 channels 0.047 to 1700 mL/min pages 56–57	
<b>EASY-LOAD® 3</b> 0.06 to 2900 mL/min pages 42–43		<b>PTFE-TUBING</b> 0.06 to 65 mL/min pages 50–51		<b>6- or 8-roller;</b> up to 12 channels 0.0005 to 350 mL/min pages 58–59	
<b>EASY-LOAD® II</b> 0.06 to 2900 mL/min pages 44–45		<b>MULTICHANNEL</b> 4- or 8-channel for microbore tubing 0.0026 to 200 mL/min pages 52–53		<b>PTFE-DIAPHRAGM</b> 10 to 800 mL/min pages 60–61	
<b>EASY-LOAD®</b> 0.06 to 2300 mL/min pages 46–47		<b>2-, 4-, or 8-channel</b> for L/S® Precision tubing 0.045 to 2300 mL/min pages 54–55			

### Dimensional Drawings cm (in.)

**Drive 07557-00, -10**

**FRONT**  
9.7 (3.81)

**SIDE**  
27.7 (10.9)  
11.7 (4.61)

**Controller 07557-00, -10**

**FRONT**  
21.1 (8.32)  
14.0 (5.5)

**SIDE**  
27.4 (10.79)  
26.3 (10.34)

---

**Drive 07557-60, -70**

**FRONT**  
17.8 (7.0)

**SIDE**  
36.2 (14.24)  
16.5 (6.5)

**Controller 07557-60, -70**

**FRONT**  
28.5 (10.16)

**BOTTOM**  
27.9 (11.0)  
11.9 (4.7)

## L/S® VARIABLE-SPEED DIGITAL STANDARD DRIVE

### FEATURES/BENEFITS

- Flow rates: 0.001 to 3400 mL/min (0.0001 to 54 GPH) with L/S tubing
- Cartridge flow rate: 0.00001 to 1700 mL/min per channel
- Four-line graphical LCD display shows four operating modes: continuous run, volume dispense, time dispense, and copy dispense—interface permits precise setting of desired flow rate or volume without over- or undershoot
- Menu-driven interface lets you select one of seven languages for programming and operation
- Set time interval (delay) between dispense cycles for hands-free dispensing
- Antidrip function ensures dispensing accuracy
- Batch count lets you set the desired number of batches and displays batches completed
- Cumulative volume function (totalizer) tracks total volume dispensed/pumped
- User-selectable metric or English units
- PWM speed control with tachometer feedback for precise, efficient control; ±0.1% speed control accuracy
- Reversible, maintenance-free brushless motor
- Drive stores one calibration value per tubing size, even when turned off
- Stackable housing is IP33 rated for wipedown
- Universal voltage, 90 to 260 VAC autoselect, 50/60 Hz
- Compatible with all L/S pump heads

### DRIVE CONTROLS

- Protected power switch located on back of drive
- Lighted display indicates power is on
- Simple programming and operation of the following via sealed membrane keypad:
  - Tubing size
  - Flow rate
  - Flow direction
  - Flow units (metric or English)
  - Motor speed (rpm)
  - Total volume
  - Dispense (volume/copy/time)
  - Antidrip
  - Batch count
  - On/off time
  - Control mode (remote/internal)
  - Prime
  - Start/stop
  - Calibration

### SETUP

- Mount pump head(s) and load tubing.
- Turn drive power on and select language.
- Select manual (internal) or remote control.
- Select motor direction.
- Prime and calibrate pump if required.
- Set flow rate through keypad.
- Press START key to begin pumping.

### SPEED CONTROL/CIRCUITRY

- Regulate motor through keypad and menus, 4 to 20 mA, or 0 to 10 V signal
- Soft start for starts without power surges
- Speed not affected by variations in power line voltage (VAC) and frequency (Hz)
- Line filters reduce outside interference
- Meets UL 61010-1, CSA C22.2, No. 61010-1; For CE mark: EN61010-1 (EU low voltage) and EN61326-1 (EU EMC)

### REMOTE CONTROL

- Speed control input: 0 to 20 mA, 4 to 20 mA, and 0 to 10 V (scaleable/invertable)
- Speed signal output: 0 to 20 mA, 4 to 20 mA, and 0 to 10 V (scaleable/invertable)
- START/STOP, CW/CCW, PRIME via contact closure
- Tach output: open collector
- Motor running indicator
- 25-pin (DB25) female connection
- Handheld remote and foot switch options; order separately under "Accessories"

### CALIBRATION

- Select TUBING CAL through the Main or Setup menu.
- Set flow direction, tubing size, and flow rate.
- Prime the tubing
- Highlight START and press ENTER, drive will run based on default volume.
- Press ENTER and adjust CAL VOLUME to the actual measured volume.
- Press ENTER to SAVE setting and EXIT.

**Note:** Digital signal processor retains one calibration value for each tubing size, even when power is turned off.

**NEW**



L/S digital standard drive 07522-20 shown with multichannel pump head 07535-04

### KEYPAD LOCK/UNLOCK FEATURE

- Lock keypad and protect settings by highlighting the lock icon and pressing ENTER
- Select LOCK and press ENTER to exit menu
- Repeat above steps to unlock keypad

ISO9001:2008  
CERTIFIED SUPPLIER



CE 2 year warranty

### ORDERING INFORMATION

Catalog number	rpm	Power (50/60 Hz) universal voltage
HL-07522-20	0.1 to 600	90 to 260 VAC
HL-07522-30	0.02 to 100	

### L/S PUMP TUBING FLOW RATE INFORMATION (mL/MIN)

Order Masterflex L/S pump tubing separately on pages 68–73.

Tubing cross section	L/S Precision pump tubing						L/S High-performance Precision pump tubing			
	L/S 13	L/S 14	L/S 16	L/S 25	L/S 17	L/S 18	L/S 15	L/S 24	L/S 35	L/S 36
Flow range @ 0.1 to 600 rpm	0.006 to 36	0.021 to 130	0.08 to 480	0.17 to 1000	0.28 to 1700	0.38 to 2300	0.17 to 1000 (0.18 to 1100)	0.28 to 1700 (0.30 to 1800)	0.38 to 2300 (0.43 to 2600)	0.48 to 2900 (0.58 to 3400)
Flow range @ 0.02 to 100 rpm	0.001 to 6	0.004 to 21	0.016 to 80	0.033 to 170	0.057 to 280	0.077 to 380	0.033 to 170 (0.036 to 180)	0.057 to 280 (0.057 to 300)	0.077 to 380 (0.086 to 430)	0.096 to 480 (0.113 to 580)

**Note:** Flow rates in parentheses can be obtained only with High-Performance pump heads.



## SPECIFICATIONS for L/S Variable-Speed Digital Standard Drive

Catalog number	<a href="#">HL-07522-20</a>	<a href="#">HL-07522-30</a>
<b>Performance Specifications</b>		
Flow capacity	0.006 to 3400 mL/min (0 to 54 GPH)	0.001 to 580 mL/min (0 to 9.2 GPH)
rpm	0.1 to 600	0.02 to 100
Number of heads accepted	2	4
Maximum torque	Starting	381 N-cm (540 oz-in)
	Running	127 N-cm (180 oz-in)
	Starting	763 N-cm (1080 oz-in)
	Running	254 N-cm (360 oz-in)
Reversible	Yes	
External control – Input	0-20 mA, 4-20 mA, 0-10 V; START/STOP, CW/CCW, PRIME via contact closure	
External control – Output	0 to 20 mA, 4 to 20 mA, 0 to 10 V, TTL pulse, drive running	
<b>Electrical Specifications</b>		
Voltage/Frequency VAC (50/60 Hz)	90 to 260, universal-voltage autoselecting	
Current	2.2 A at 115 V; 1.1 A at 230 V	
Fuse rating	3.15 A / 250 V	
Motor type	Continuous-duty, brushless DC	
Motor size	75 W (1/10 hp)	
Display	Four-line graphical LCD	
Motor/speed control type	PWM with microprocessor	
Speed regulation (repeatability)	±0.1% (±0.1 rpm at 600 rpm, ±0.01 rpm at 100 rpm)	
Soft start/Electronic brake	Yes/Yes	
<b>Physical Specifications</b>		
Housing materials	Stackable ABS plastic housing, coated aluminum chassis	
IP rating†	IP33	
Agency listings	ETL, cETL, CE	
Operating temperature	0 to 40°C (32 to 104°F)	
Storage temperature	-25 to 65°C (-13 to 149°F)	
Dimensions (L x W x H)	27.4 x 21.2 x 21.6 cm (10 9/16" x 8 3/8" x 8 1/2")	
Shipping weight	5.9 kg (13 lb)	

†See page 194 for an explanation of IP ratings

## ACCESSORIES

**HL-07523-92 Foot switch**, momentary start/stop; 1.8-m (6-ft) cable.

**HL-07523-95 Cable assembly**, DB25 male connector and 7.9-m (25-ft) cable with stripped wire ends for remote control.

**HL-07523-94 DB25 male connector**, use to create your own cable.

**HL-07523-97 Handheld remote controller**; route tubing through handle for dispensing and filling applications; 1.8-m (6-ft) cable.

**HL-07523-98 Tilt bail**; use to securely elevate front of drive.

**HL-17050-01 NIST-traceable calibration** with data for peristaltic pump drive.

## SEE PAGES 108–117

For complete L/S pump systems



77921-65

## Dimensional Drawings cm (in.) 07522-series

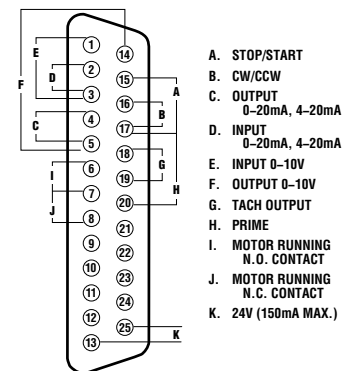
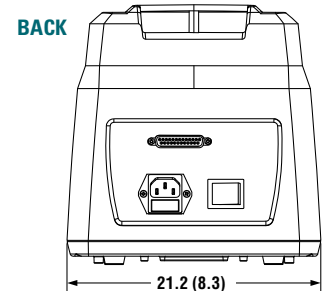
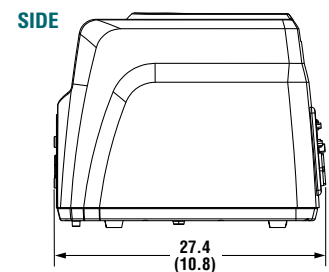
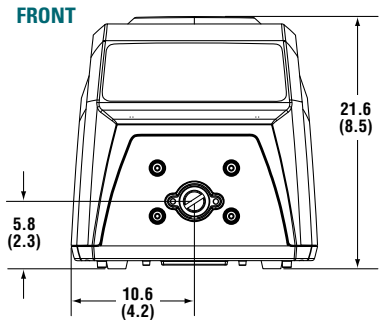

<b>STANDARD</b> 0.001 to 2900 mL/min pages 40–41		<b>HIGH-PERFORMANCE</b> 0.018 to 3400 mL/min pages 48–49		<b>MULTICHANNEL CARTRIDGE</b> 3- or 4-roller; up to 8 channels 0.001 to 1700 mL/min pages 56–57	
<b>EASY-LOAD* 3</b> 0.001 to 2900 mL/min pages 42–43		<b>PTFE-TUBING</b> 0.001 to 65 mL/min pages 50–51		6- or 8-roller; up to 12 channels 0.00001 to 350 mL/min pages 58–59	
<b>EASY-LOAD* II</b> 0.001 to 2900 mL/min pages 44–45		<b>MULTICHANNEL</b> 4- or 8-channel for microbore tubing 0.00005 to 200 mL/min pages 52–53		<b>PTFE-DIAPHRAGM</b> 10 to 800 mL/min pages 60–61	
<b>EASY-LOAD*</b> 0.001 to 2300 mL/min pages 46–47		2-, 4-, or 8-channel for L/S® Precision tubing 0.001 to 2300 mL/min pages 54–55			

L/S® PUMP HEADS..... 38–67  
L/S® TUBING ..... 68–73  
L/S® PUMP SYSTEMS ..... 108–117

ACCESSORIES..... 160–171

TECHNICAL DATA..... 172–206

## L/S® DIGITAL MODULAR DISPENSING DRIVES

### FEATURES/BENEFITS

- ▶ Flow rates: 0.006 to 3400 mL/min with L/S tubing
- ▶ Cartridge flow rate: 0.00005 to 1700 mL/min per channel
- ▶ Modular format lets you separate drive and controller for convenient placement; a 1.8-m (6-ft) control cable is included. Extend that distance with optional 2.7-m (9-ft) extension cable
- ▶ Four-line graphical LCD shows four operating modes: continuous run, volume dispense, time dispense, and copy dispense—interface permits precise setting of desired flow rate or volume without over- or undershoot
- ▶ Select one of seven languages for programming and operation
- ▶ Set time interval (delay) between dispense cycles for hands-free dispensing
- ▶ Antidrip function ensures dispensing accuracy
- ▶ Batch count lets you set the number of batches and displays number of batches completed
- ▶ Cumulative volume function (totalizer) tracks total volume dispensed/pumped
- ▶ User selectable English or metric flow/volume units
- ▶ PWM speed control with tachometer feedback for ±0.1% speed control accuracy
- ▶ Reversible, maintenance-free brushless motor
- ▶ Universal voltage, 90 to 260 VAC autoselect, 50/60 Hz
- ▶ Compatible with all L/S pump heads

### DRIVE CONTROLS

- ▶ Protected power switch located on back of drive
- ▶ Lighted display indicates power is on
- ▶ Simple programming and operation of the following via sealed membrane keypad:
  - ◆ Tubing size
  - ◆ Flow rate
  - ◆ Flow direction
  - ◆ Flow units (English or metric)
  - ◆ Motor speed (rpm)
  - ◆ Total volume
  - ◆ Dispense (volume/copy/time)
  - ◆ Batch count
  - ◆ On/off time
  - ◆ Antidrip
  - ◆ Control mode (remote/internal)
  - ◆ Prime
  - ◆ Start/stop
  - ◆ Calibration



Digital modular drive 77301-30 shown with Easy-Load® II pump head 77200-62



**NEW**  
Benchtop modular digital drive 77301-20

### SETUP

1. Mount pump head(s) and load tubing.
2. Turn drive power on and select language.
3. Select manual (internal) or remote control.
4. Select motor direction.
5. Prime and calibrate pump if required.
6. Set flow rate through keypad.
7. Press START key to begin pumping.

### SPEED CONTROL/CIRCUITRY

- ▶ Regulate motor through keypad and menus, 4 to 20 mA, or 0 to 10 V signal
- ▶ Soft start for starts without power surges
- ▶ Speed not affected by variations in power line voltage (VAC) and frequency (Hz)
- ▶ Line filters reduce outside interference
- ▶ Meets UL 61010-1, CSA C22.2, No. 61010-1; for CE mark: EN61010-1 (EU low voltage) and EN61326-1 (EU EMC)

### REMOTE CONTROL

#### Benchtop Modular Drive

- ▶ Remote control via 25-pin (DB25) female connection on back of controller
- ▶ Speed control input: 0 to 20 mA, 4 to 20 mA, and 0 to 10 V (scaleable/invertable)
- ▶ Speed signal output: 0 to 20 mA, 4 to 20 mA, and 0 to 10 V (scaleable/invertable)
- ▶ START/STOP, CW/CCW, PRIME via contact closure
- ▶ Tach output: open collector
- ▶ Motor running indicator
- ▶ Handheld remote, cable, and foot switch options; order separately under "Accessories"

### Modular Drive with Washdown, Wall-Mount Controller

- ▶ Remote control via 31-pin weather-resistant circular connection on bottom of controller
- ▶ Speed control input: 0 to 20 mA, 4 to 20 mA, and 0 to 10 V (scaleable/invertable)
- ▶ Speed signal output: 0 to 20 mA, 4 to 20 mA, and 0 to 10 V (scaleable/invertable)
- ▶ START/STOP, CW/CCW, PRIME via contact closure
- ▶ Tach output: open collector
- ▶ Motor running indicator
- ▶ Remote cable and foot switch options; order separately under "Accessories"

### CALIBRATION

1. Select TUBING CAL via the Main or Setup menu.
2. Set flow direction, tubing size, and flow rate.
3. Prime the tubing.
4. Highlight START and press ENTER, drive will run based on default volume.
5. Press ENTER and adjust CAL VOLUME to the actual measured volume.
6. Press ENTER to SAVE setting and EXIT.

**NOTE:** Digital signal processor retains one calibration value for each tubing size, even when power is turned off.



### ORDERING INFORMATION

Catalog number	rpm	Power (50/60 Hz)
<b>Benchtop digital modular drive</b>		
<a href="#">HL-77301-40</a>	0.1 to 600	90 to 260 VAC
<b>Digital modular drive with washdown controller</b>		
<a href="#">HL-77301-50</a>	0.1 to 600	90 to 260 VAC

### L/S PUMP TUBING FLOW RATE INFORMATION (mL/MIN)

Order Masterflex L/S pump tubing separately on pages 68–73.

Tubing cross sections	L/S Precision pump tubing						L/S High-performance Precision pump tubing			
	L/S 13	L/S 14	L/S 16	L/S 25	L/S 17	L/S 18	L/S 15	L/S 24	L/S 35	L/S 36
Flow range @ 0.1 to 600 rpm	0.006 to 36	0.021 to 130	0.08 to 480	0.17 to 1000	0.28 to 1700	0.38 to 2300	0.18 to 1000 (0.18 to 1100)	0.28 to 1700 (0.30 to 1800)	0.38 to 2300 (0.43 to 2600)	0.48 to 2900 (0.58 to 3400)

Note: Higher flow rates in parentheses can be obtained only with High-Performance pump head.



## SPECIFICATIONS for L/S Digital Modular Dispensing Drives

Catalog number	HL-77301-40	HL-77301-50
<b>Performance Specifications</b>		
Flow capacity	0.006 to 3400 mL/min (0 to 54 GPH)	
rpm	0.1 to 600	
Number of heads accepted	2	
Maximum torque	381 N-cm (540 oz-in)	
	127 N-cm (180 oz-in)	
Reversible	Yes	
External control – Input	0 to 20 mA, 4 to 20 mA, 0 to 10 V; START/STOP, CW/CCW, PRIME via contact closure	
External control – Output	1 to 20 mA, 4 to 20 mA, 0 to 10 V; TTL pulse, drive running	
<b>Electrical Specifications</b>		
Voltage/Frequency VAC (Hz)	90 to 260 (50/60)	
Current	1.8 A at 115 V; 1.1 A at 230 V	
Fuse rating	3.15 A / 250 V	
Motor type	Continuous duty, brushless DC	
Motor size	75 W (1/10 hp)	
Display	Four-line graphical LCD	
Motor/speed control type	PWM with microprocessor	
Speed regulation	±0.1%	
Soft start/Electronic brake	Yes/Yes	
<b>Physical Specifications</b>		
Housing materials	Drive	Painted steel and aluminum
	Controller	Painted steel and aluminum
IP rating	Drive	IP33
	Controller	IP66 (NEMA 4X)
Agency listings	ETL, cETL, CE	
Operating temperature	0 to 40°C (32 to 104°F)	
Storage temperature	-25 to 65°C (-13 to 149°F)	
Dimensions (L x W x H)	Drive	22.7 x 9.7 x 12 cm (8 7/8" x 3 3/4" x 4 3/4")
	Controller	26.3 x 21.1 x 14.0 cm (10 1/8" x 8 3/8" x 5 1/2")
Shipping weight	7.1 kg (15.6 lb)	14.1 kg (31.1 lb)

## ACCESSORIES

### For Benchtop Model 77301-40

**HL-07523-97 Handheld remote controller**; control start/stop, direction, and prime; route tubing through handle for dispensing and filling applications; 1.8-m (6-ft) cable.

**HL-07523-92 Foot switch**, momentary start/stop; 1.8-m (6-ft) cable.

**HL-07523-95 Cable assembly**, DB25 male connector and 7.9-m (25-ft) cable with stripped wire ends for remote control.

**HL-77301-82 Extension cable**, 2.7 m (9 ft), for benchtop modular drive 77301-40; extends distance between motor and controller.

**HL-17050-01 NIST-traceable calibration** with data for peristaltic pump drive.

### For Washdown Model 77301-50

**HL-07575-84 Washdown foot switch**, momentary start/stop; 1.8-m (6-ft) cable.

**HL-77301-82 Extension cable**, 2.7 m (9 ft), for washdown modular drive 77301-50; extends distance between motor and controller.

**HL-07575-80 Remote control cable**; wire to controller/PLC; 8.3-m (25-ft) length.

**HL-17050-01 NIST-traceable calibration** with data for peristaltic pump drive.

## KEYPAD LOCK/UNLOCK FEATURE

- Lock keypad and protect settings by highlighting the lock icon and pressing ENTER.
- Select LOCK and press ENTER to exit menu.
- Repeat above steps to unlock keypad.

## SELECTION CRITERIA

- Motor rpm / flow rate.
- Number of pump heads accepted.
- Benchtop or washdown, wall-mount controller.

**Order pump heads and tubing separately.**

<b>STANDARD</b> 0.06 to 2900 mL/min pages 40–41		<b>HIGH-PERFORMANCE</b> 0.9 to 3400 mL/min pages 48–49		<b>MULTICHANNEL CARTRIDGE</b> 3- or 4-roller; up to 8 channels 0.047 to 1700 mL/min pages 56–57	
<b>EASY-LOAD* 3</b> 0.06 to 2900 mL/min pages 42–43		<b>PTFE-TUBING</b> 0.06 to 65 mL/min pages 50–51		6- or 8-roller; up to 12 channels 0.0005 to 350 mL/min pages 58–59	
<b>EASY-LOAD* II</b> 0.06 to 2900 mL/min pages 44–45		<b>MULTICHANNEL</b> 4- or 8-channel tubing for microbore tubing 0.0026 to 200 mL/min pages 52–53		<b>PTFE-DIAPHRAGM</b> 10 to 800 mL/min pages 60–61	
<b>EASY-LOAD*</b> 0.06 to 2300 mL/min pages 46–47		2-, 4-, or 8-channel for L/S® Precision tubing 0.045 to 2300 mL/min pages 54–55			

### Dimensional Drawings cm (in.)

#### 77301-40 Drive

**FRONT**

**SIDE**

#### 77301-40 Controller

**FRONT**

**SIDE**

---

#### 77301-50 Drive

**FRONT**

**SIDE**

#### 77301-50 Controller

**FRONT**

**BOTTOM**

## L/S® DIGITAL PROCESS DRIVES

### FEATURES/BENEFITS

- ▶ Flow rates: 0.006 to 3400 mL/min (0.0001 to 54 GPH) with L/S tubing
- ▶ Cartridge flow rate: 0.0005 to 1700 mL/min per channel
- ▶ Washdown process drive is IP66, NEMA 4X rated
- ▶ Model 07575-10 with electropolished 316 stainless steel housing withstands common cleaning and sanitizing solutions; use powder-coat steel model 07575-20 in applications where stainless steel is not a critical requirement
- ▶ Four-line graphical LCD shows four operating modes: continuous run, volume dispense, time dispense, and copy dispense—interface permits precise setting of desired flow rate or volume without over- or undershoot
- ▶ Menu-driven interface lets you select one of seven languages for programming and operation
- ▶ Set time interval (delay) between dispense cycles for hands-free dispensing
- ▶ Batch count lets you set the desired number of batches and displays number completed
- ▶ Cumulative volume function (totalizer) tracks total volume dispensed/pumped
- ▶ User-selectable metric or English units
- ▶ PWM speed control with tachometer feedback for ±0.1% speed control accuracy
- ▶ Reversible, maintenance-free brushless motor
- ▶ Drive stores one calibration value per tubing size
- ▶ Universal voltage, 90 to 260 VAC autoselect
- ▶ Compatible with all L/S pump heads

### DRIVE CONTROLS

- ▶ Protected power switch located on back of drive
- ▶ Lighted display indicates power is on
- ▶ Simple programming and operation of the following via sealed membrane keypad:
  - ◆ Tubing size
  - ◆ Flow rate
  - ◆ Flow direction
  - ◆ Flow units (metric or English)
  - ◆ Motor speed (rpm)
  - ◆ Total volume
  - ◆ Dispense (volume/copy/time)
  - ◆ Batch count
  - ◆ On/off time
  - ◆ Control mode (remote/internal)
  - ◆ Prime
  - ◆ Start/stop
  - ◆ Calibration



L/S digital process drive 07575-10 shown with High-Performance pump head 77250-62



L/S digital process drive 07575-20 shown with Easy-Load® II pump head 77200-62

### SETUP

1. Mount pump head(s) and load tubing.
2. Turn drive power on and select language.
3. Select manual (internal) or remote control.
4. Select motor direction.
5. Prime and calibrate pump if required.
6. Set flow rate through keypad.
7. Press START key to begin pumping.

### SPEED CONTROL/CIRCUITRY

- ▶ Regulate motor through keypad and menus, 4 to 20 mA, or 0 to 10 V signal
- ▶ Soft start for starts without power surges
- ▶ Speed not affected by variations in power line voltage (VAC) and frequency (Hz)
- ▶ Line filters reduce outside interference
- ▶ Meets UL 61010-1, CSA C22.2, No. 61010-1; For CE mark: EN61010-1 (EU low voltage) and EN61326-1 (EU EMC)

### REMOTE CONTROL

- ▶ Speed control input: 0 to 20 mA, 4 to 20 mA, and 0 to 10 V (scalable/invertible)
- ▶ Speed signal output: 0 to 20 mA, 4 to 20 mA, and 0 to 10 V (scalable/invertible)
- ▶ START/STOP, CW/CCW, PRIME via contact closure
- ▶ Tach output: open collector
- ▶ Motor running indicator
- ▶ 31-pin circular waterproof connection
- ▶ Remote control and foot switch options; order separately under "Accessories"



### ORDERING INFORMATION

Catalog number	rpm	Power (50/60 Hz) universal voltage
<b>Digital process drive with 316 stainless steel housing</b>		
<a href="#">HL-07575-10</a>	0.1 to 600	90 to 260 VAC
<b>Digital process drive with powder-coat steel housing</b>		
<a href="#">HL-07575-20</a>	0.1 to 600	90 to 260 VAC

### L/S PUMP TUBING FLOW RATE INFORMATION (mL/MIN)

Order Masterflex L/S pump tubing separately on pages 68-73

Tubing cross section	L/S Precision pump tubing						L/S High-performance Precision pump tubing			
	L/S 13	L/S 14	L/S 16	L/S 25	L/S 17	L/S 18	L/S 15	L/S 24	L/S 35	L/S 36
Flow range @ 0.1 to 600 rpm	0.006 to 36	0.02 to 130	0.08 to 480	0.17 to 1000	0.28 to 1700	0.38 to 2300	0.17 to 1000 (0.18 to 1100)	0.28 to 1700 (0.30 to 1800)	0.38 to 2300 (0.43 to 2600)	0.48 to 2900 (0.57 to 3400)

Note: Flow rates in parentheses can be obtained only with the High-Performance pump head



## SPECIFICATIONS for L/S Digital Process Drives

Catalog number	<a href="#">HL-07575-10</a>	<a href="#">HL-07575-20</a>
<b>Performance Specifications</b>		
Flow capacity	0.006 to 3400 mL/min (0.0001 to 54 GPH)	
rpm	0.1 to 600	
Number of heads accepted	2	
Maximum torque	Starting	381 N-cm (540 oz-in)
	Running	127 N-cm (180 oz-in)
Reversible	Yes	
External control-Input	0 to 20 mA, 4 to 20 mA, 0 to 10 V; Start/Stop, CW/CCW, Prime	
External control-Output	0 to 20 mA, 4 to 20 mA, 0 to 10 V; TTL; "drive running" contact	
<b>Electrical Specifications</b>		
Voltage/Frequency VAC (50/60 Hz)	90 to 260, universal-voltage, autoselecting	
Current	2.2 A at 115 V; 1.1 A at 230 V	
Fuse rating	3.15 A	
Motor type	Continuous-duty, brushless DC	
Motor size	75 W (1/10 hp)	
Display	Four-line graphical LCD	
Motor/speed control type	PWM with microprocessor	
Speed regulation (repeatability)	±0.1%	
Soft-Start/Electronic brake	Yes/Yes	
<b>Physical Specifications</b>		
Housing materials	316 stainless steel, electropolished	Powder-coated steel
IP rating <sup>†</sup>	IP66 (NEMA 4X)	
Agency listings	ETL, cETL, CE	
Operating temperature	0 to 40°C (32 to 104°F)	
Storage temperature	-25 to 65°C (-13 to 149°F)	
Dimensions (L x W x H)	30.5 x 22.9 x 23.6 cm (12" x 9" x 9 1/16")	
Shipping weight	11.8 kg (26 lb)	

<sup>†</sup>See page 194 for an explanation of IP ratings.

## CALIBRATION

1. Select TUBING CAL through the Main or Setup menu.
2. Set flow direction, tubing size, and flow rate
3. Prime the tubing.
4. Highlight START and press ENTER, drive will run based on default volume.
5. Press ENTER and adjust CAL VOLUME to the actual measured volume.
6. Press ENTER to SAVE setting and EXIT.

**Note:** Digital signal processor retains one calibration value for each tubing size, even when power is turned off.

## KEYPAD LOCK/UNLOCK FEATURE

- ▶ Lock keypad and protect settings by highlighting the lock icon and pressing ENTER
- ▶ Select LOCK and press ENTER to exit menu
- ▶ Repeat above steps to unlock keypad

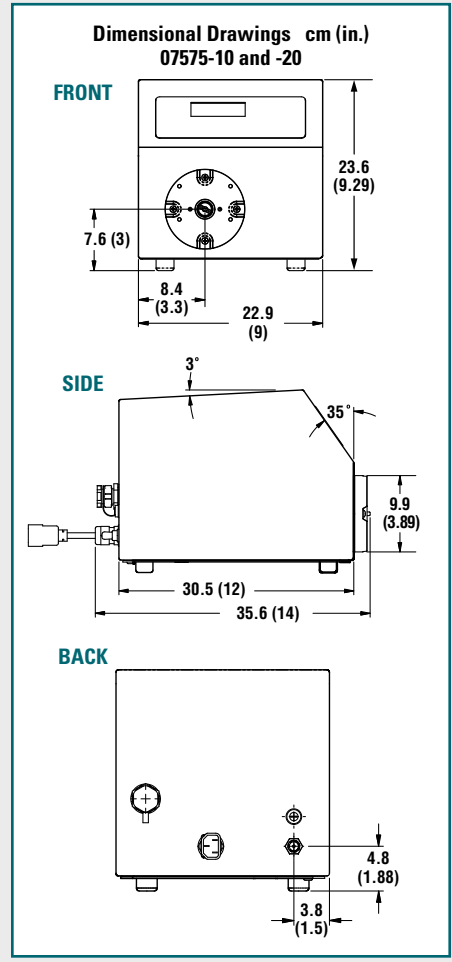

## ACCESSORIES

**HL-07575-84 Washdown foot switch**, momentary start/stop; 1.8-m (6-ft) cable.

**HL-07575-80 Remote control cable**; wire to controller/PLC; 8.3-m (25-ft) length.

**HL-07575-01 Replacement seal kit** includes shaft seal, hardware, and gasket.

**HL-17050-01 NIST-traceable calibration** for peristaltic pump drive.



Pump heads can be stacked on the L/S digital process drive to increase flow rates. Shown are stacked L/S Easy-Load® II pump heads 77200-62.

<b>STANDARD</b> 0.006 to 2900 mL/min pages 40-41		<b>HIGH-PERFORMANCE</b> 0.09 to 3400 mL/min pages 48-49		<b>MULTICHANNEL CARTRIDGE</b> 3- or 4-roller; up to 8 channels 0.005 to 1700 mL/min pages 56-57	
<b>EASY-LOAD® 3</b> 0.006 to 2900 mL/min pages 42-43		<b>PTFE-TUBING</b> 0.006 to 65 mL/min pages 50-51		<b>6- or 8-roller;</b> up to 12 channels 0.00005 to 350 mL/min pages 58-59	
<b>EASY-LOAD® II</b> 0.006 to 2900 mL/min pages 44-45		<b>MULTICHANNEL</b> 4- or 8-channel for microbore tubing 0.0003 to 200 mL/min pages 52-53		<b>PTFE-DIAPHRAGM</b> 10 to 800 mL/min pages 60-61	
<b>EASY-LOAD®</b> 0.006 to 2300 mL/min pages 46-47		<b>2-, 4-, or 8-channel for L/S® Precision tubing</b> 0.005 to 2300 mL/min pages 54-55			

L/S® PUMP HEADS..... 38-67  
L/S® TUBING ..... 68-73  
L/S® PUMP SYSTEMS ..... 108-117

ACCESSORIES..... 160-171

TECHNICAL DATA..... 172-206

## L/S® COMPUTER-COMPATIBLE PROGRAMMABLE DRIVES

### FEATURES/BENEFITS

- ▶ Flow rates: 0.001 to 3400 mL/min (0.0001 to 54 GPH) with L/S tubing
- ▶ Cartridge flow rate: 0.00001 to 1700 mL/min per channel
- ▶ Use as a stand-alone digital dispensing drive or interface with a PC for automated and multi-drive applications
- ▶ Four-line graphical LCD shows four operating modes: continuous run, volume dispense, time dispense, and copy dispense
- ▶ Menu-driven interface lets you select from one of seven languages for programming and operation
- ▶ Set time interval (delay) between dispense cycles for hands-free dispensing
- ▶ Batch count lets you set the desired number of batches and displays number of batches completed
- ▶ Cumulative volume function (totalizer) tracks total volume dispensed/pumped
- ▶ User-selectable metric or English flow units
- ▶ PWM speed control with tachometer feedback; ±0.1% speed control accuracy
- ▶ Reversible, maintenance-free brushless motor
- ▶ Drive stores one calibration value per tubing size, even when turned off
- ▶ Stackable housing is IP33 rated for wipedown
- ▶ Compatible with all L/S pump heads

### DRIVE CONTROLS

- ▶ Protected power switch located on back of drive
- ▶ Lighted display indicates power is on
- ▶ Simple programming and operation of the following via sealed membrane keypad:
  - ◆ Tubing size
  - ◆ Flow rate
  - ◆ Flow direction
  - ◆ Flow units (metric or English)
  - ◆ Motor speed (rpm)
  - ◆ Total volume
  - ◆ Dispense (volume/copy/time)
  - ◆ Batch count
  - ◆ On/off time
  - ◆ Control mode (remote/internal)
  - ◆ Prime
  - ◆ Start/stop
  - ◆ Calibration

### SETUP

1. Mount pump head(s) and load tubing.
2. Turn drive power on and select language.
3. Select manual (internal) or remote control.
4. Select motor direction.
5. Prime and calibrate pump if required.
6. Set flow rate through keypad.
7. Press START key to begin pumping.

### SPEED CONTROL/CIRCUITRY

- ▶ Regulate motor through keypad and menus, 4 to 20 mA, or 0 to 10 V signal
- ▶ Soft start for starts without power surges
- ▶ Speed not affected by variations in power line voltage (VAC) and frequency (Hz)
- ▶ Line filters reduce outside interference
- ▶ Meets UL 61010-1, CSA C22.2, No. 61010-1; For CE mark: EN61010-1 (EU low voltage) and EN61326-1 (EU EMC)

### REMOTE CONTROL

- ▶ Speed control input: 0 to 20 mA, 4 to 20 mA, and 0 to 10 V (scaleable/invertable)
- ▶ Speed signal output: 0 to 20 mA, 4 to 20 mA, and 0 to 10 V (scaleable/invertable)
- ▶ START/STOP, CW/CCW, PRIME via contact closure
- ▶ Tach output: open collector
- ▶ Motor running indicator
- ▶ 25-pin (DB25) female connection
- ▶ Two programmable auxiliary contacts and auxiliary 24 VDC power supply output
- ▶ Input/output via RS-232 serial (DB9) and USB Type B mini port
- ▶ Handheld remote and foot switch options; order separately under "Accessories"

### CALIBRATION

1. Select TUBING CAL through the Main or Setup menu.
2. Set flow direction, tubing size, and flow rate.
3. Prime the tubing.
4. Highlight START and press ENTER, drive will run based on default volume.



L/S® Computer-compatible brushless drive 07551-00 shown with L/S High-performance pump head 77250-62 and L/S 15 PharmaPure® tubing.

5. Press ENTER and adjust CAL VOLUME to the actual measured volume.
6. Press ENTER to SAVE setting and EXIT.

**NOTE:** Digital signal processor retains one calibration value for each tubing size, even when power is turned off.

### KEYPAD LOCK/UNLOCK FEATURE

- ▶ Lock keypad and protect settings by highlighting the lock icon and pressing ENTER
- ▶ Select LOCK and press ENTER to exit menu
- ▶ Repeat above steps to unlock keypad



### ORDERING INFORMATION

Catalog number	rpm	Power (50/60 Hz) universal voltage
<a href="#">HL-07551-00</a>	0.1 to 600	90 to 260 VAC
<a href="#">HL-07551-10</a>	0.02 to 100	

### L/S PUMP TUBING FLOW RATE INFORMATION (mL/MIN)

Order Masterflex L/S pump tubing separately on pages 68–73.

Tubing cross section	L/S Precision pump tubing						L/S High-performance Precision pump tubing			
	L/S 13	L/S 14	L/S 16	L/S 25	L/S 17	L/S 18	L/S 15	L/S 24	L/S 35	L/S 36
Flow range @ 0.1 to 600 rpm	0.006 to 36	0.021 to 130	0.08 to 480	0.17 to 1000	0.28 to 1700	0.38 to 2300	0.17 to 1000 (0.18 to 1100)	0.28 to 1700 (0.30 to 1800)	0.38 to 2300 (0.43 to 2600)	0.48 to 2900 (0.58 to 3400)
Flow range @ 0.02 to 100 rpm	0.001 to 6	0.004 to 21	0.016 to 80	0.033 to 170	0.057 to 280	0.077 to 380	0.033 to 170 (0.036 to 180)	0.057 to 280 (0.057 to 300)	0.077 to 380 (0.086 to 430)	0.096 to 480 (0.113 to 580)

**Note:** Flow rates in parentheses can be obtained only with Masterflex L/S High-Performance pump heads.





## SPECIFICATIONS for L/S Computer-Compatible Programmable Drives

Catalog number	<a href="#">HL-07551-00</a>	<a href="#">HL-07551-10</a>
<b>Performance Specifications</b>		
Flow capacity	0.006 to 3400 mL/min (0 to 54 GPH)	0.001 to 580 mL/min (0 to 9.2 GPH)
rpm	0.1 to 600	0.02 to 100
Number of heads accepted	2	4
Maximum torque	Starting	381 N-cm (540 oz-in)
	Running	127 N-cm (180 oz-in)
Reversible	Yes	
External control-Input	RS-232, USB, 0-20 mA, 4-20 mA, 0-10 V; START/STOP, CW/CCW, PRIME via contact closure	
External control-Output	RS-232, USB, 0-20 mA, 4-20 mA, 0-10 V, TTL pulse, drive running	
<b>Electrical Specifications</b>		
Voltage/Frequency VAC (50/60 Hz)	90 to 260, universal-voltage autoselecting	
Current	2.2 A at 115 V; 1.1 A at 230 V	
Fuse rating	3.15 A / 250 V	
Motor type	Continuous-duty, brushless DC	
Motor size	75 W (1/10 hp)	
Display	Four-line graphical LCD	
Motor/speed control type	PWM with microprocessor	
Speed regulation (repeatability)	±0.1% (±0.1 rpm at 600 rpm, ±0.01 rpm at 100 rpm)	
Soft start/Electronic brake	Yes/Yes	
<b>Physical Specifications</b>		
Housing materials	Stackable ABS plastic housing, coated aluminum chassis	
IP rating†	IP33	
Agency listings	ETL, cETL, CE	
Operating temperature	0 to 40°C (32 to 104°F)	
Storage temperature	-25 to 65°C (-13 to 149°F)	
Dimensions (L x W x H)	27.4 x 21.2 x 21.6 cm (10.8" x 8.3" x 8.5")	
Shipping weight	5.9 kg (13 lb)	

† See page 194 for an explanation of IP ratings

## ACCESSORIES

**HL-07523-92 Foot switch**, momentary start/stop; 1.8-m (6-ft) cable.

**HL-07523-95 Cable assembly**, DB25 male connector and 7.9-m (25-ft) cable with stripped wire ends for remote control.

**HL-07523-94 DB25 male connector**, use to create your own cable.

**HL-07523-97 Handheld remote controller**; route tubing through handle for dispensing and filling applications; 1.8-m (6-ft) cable.

**HL-07523-98 Tilt bail**; use to securely elevate front of drive.

**HL-17050-01 NIST-traceable calibration** for peristaltic pump drive.

## SEE PAGES 108-117

For complete L/S pump systems



77924-50

## Dimensional Drawings cm (in.) 07551-series

### FRONT

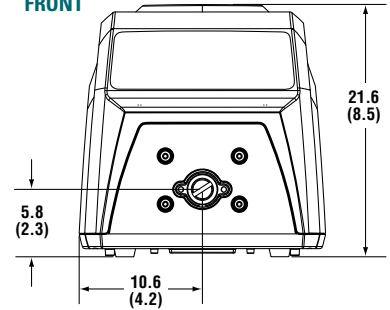

### SIDE

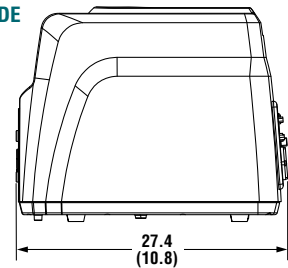

### BACK

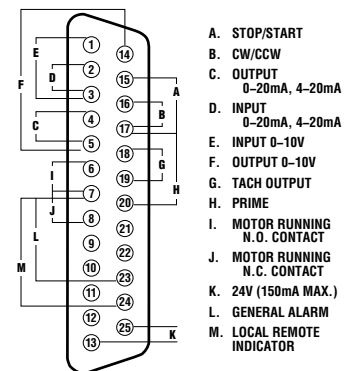
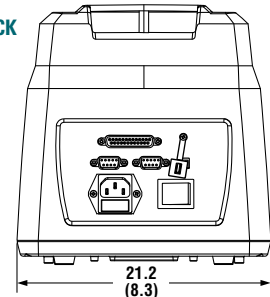

<b>STANDARD</b> 0.001 to 2900 mL/min pages 40-41		<b>HIGH-PERFORMANCE</b> 0.018 to 3400 mL/min pages 48-49		<b>MULTICHANNEL CARTRIDGE</b> 3- or 4-roller; up to 8 channels 0.001 to 1700 mL/min pages 56-57	
<b>EASY-LOAD* 3</b> 0.001 to 2900 mL/min pages 42-43		<b>PTFE-TUBING</b> 0.001 to 65 mL/min pages 50-51		6- or 8-roller; up to 12 channels 0.00001 to 350 mL/min pages 58-59	
<b>EASY-LOAD* II</b> 0.001 to 2900 mL/min pages 44-45		<b>MULTICHANNEL</b> 4- or 8-channel for microbore tubing 0.00005 to 200 mL/min pages 52-53		<b>PTFE-DIAPHRAGM</b> 10 to 800 mL/min pages 60-61	
<b>EASY-LOAD*</b> 0.001 to 2300 mL/min pages 46-47		2-, 4-, or 8-channel for L/S® Precision tubing 0.001 to 2300 mL/min pages 54-55			

L/S® PUMP HEADS.....38-67  
L/S® TUBING ..... 68-73  
L/S® PUMP SYSTEMS ..... 108-117

ACCESSORIES ..... 160-171

TECHNICAL DATA..... 172-206

## SERVO DYNE™ ELECTRONIC MIXERS

### FEATURES/BENEFITS

- ▶ Modular design features easy customization to suit your needs
- ▶ Convenient, ready-made systems come complete with controller, mixer head, shaft, propeller, clamp, and stand
- ▶ Speed ranges up to 6000 rpm
- ▶ Torque ranges to 360 N-cm
- ▶ All components operate on 115 VAC, 50/60 Hz

### COMPUTER COMPATIBILITY

- ▶ All Servodyne mixer functions can be controlled through a PC workstation

### MIXER HEADS

- ▶ Adjustable-tilt mounting assembly permits rotation of mixer head from 0 to 30° for proper positioning of shaft and propeller
- ▶ High-torque, low-speed mixer heads have a keyless chuck; high-speed, low-torque mixer heads have an adjustable through-shaft collet to allow positioning of the mixing propeller at any depth without moving the mixer head

### DRIVE CONTROLS

- ▶ Protected on/off power switch located on top of each mixer motor
- ▶ LED display provides read-out including time, torque, rpm, and start/stop
- ▶ Precise control of mixing speed within ±0.2% despite changes in viscosity, temperature, or line voltage
- ▶ Optical shaft encoder relays the exact motor rotation speed data to the electronic mixer controller

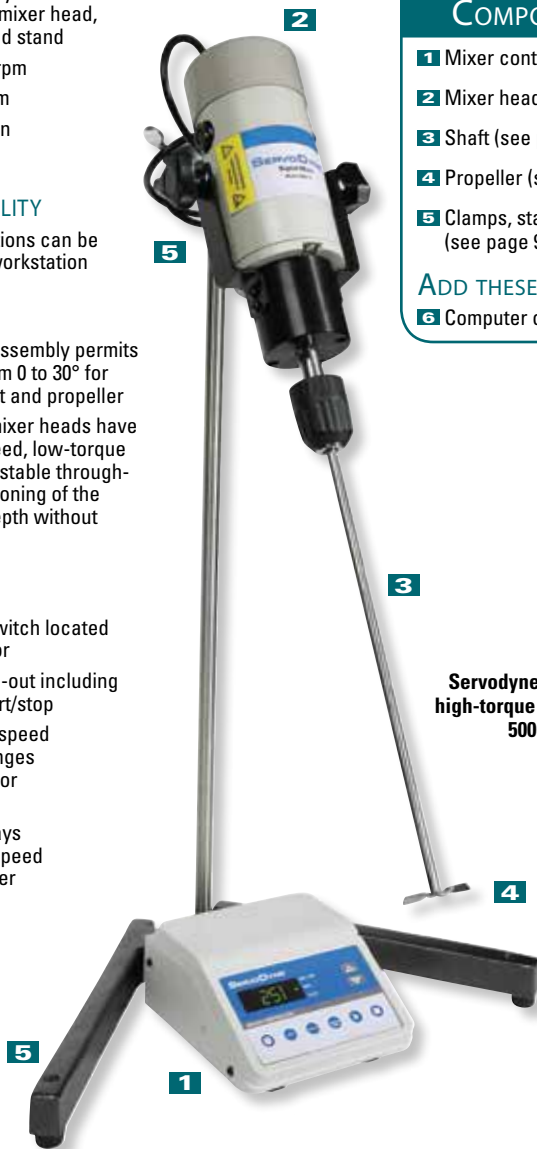

### REQUIRED SYSTEM COMPONENTS

- 1 Mixer controller
- 2 Mixer head
- 3 Shaft (see page 97)
- 4 Propeller (see page 97)
- 5 Clamps, stand and supports (see page 97)

### ADD THESE OPTIONS

- 6 Computer cable

Servodyne low-speed, high-torque mixer system 50008-22

### Controller Features

#### FRONT



#### REAR

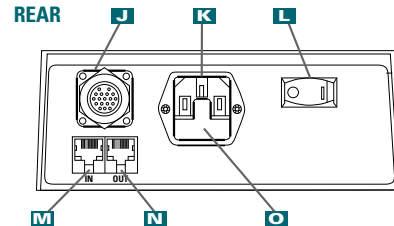

- A Display:** Shows selected mixing time, mixing time remaining, rpm, and torque values.
- B Time:** Starts counting down when the START key is pressed.
- C Rpm:** Displays the last adjusted mixer shaft speed.
- D Torque:** Displays current torque value (oz-in for 115 VAC model, kg-cm for 230 VAC model) and high and low torque limits.
- E Torque zero:** Lets you zero the torque when propeller is running in free air or in a reference fluid.
- F Start:** Operates the mixer shaft. Stops when countdown reaches zero.
- G Stop:** Press at any time to stop rotation of the mixer shaft.
- H Up/down arrow keys:** Adjust time, rpm, and torque parameters.
- I LEDs** indicate the function being displayed.
- J Mixer head plug receptacle:** Multipin plug enables microprocessor to identify connected mixer head and properly control speed and torque.
- K IEC 320:** Power entry module.
- L Power switch:** All settings are retained in memory
- M IN RS-232:** Connect cable from host computer.
- N OUT RS-232:** Connect cable to next mixer.
- O Fuse:** T3.15A (115 VAC), T1.6A (230 VAC).

### ORDERING INFORMATION

ISO9001:2008  
CERTIFIED SUPPLIER



2 year  
warranty

1 Controller		2 Mixer heads					Complete systems
Catalog number	Catalog number	Description	Speed (rpm)	hp	Max torque (N-cm)		Catalog number
					Continuous	Intermittent	
HL-50008-00	HL-50008-10	High torque, low speed	3 to 180	50 W	240	360	HL-50008-12
	HL-50008-20		20 to 900	50 W	49	74	HL-50008-22
	HL-50008-30	High speed, low torque	60 to 2300	75 W	32	46	HL-50008-32
HL-50008-40	150 to 6000		75 W	12	18	HL-50008-42	

### 6 Computer Cable

**HL-07550-64 RS-232 interface cable**, 2.4-m (8-ft) long. Connects Servodyne mixer system to a PC. RJ11 to DB25 connection; includes DB25/DB9 adapter



## Stir-Pak® HEAVY-DUTY MIXERS

### FEATURES/BENEFITS

- ▶ Modular design offers maximum versatility, easily customize to your needs
- ▶ Convenient, ready-made systems come complete with controller, mixer head, shaft, propeller, clamp, and stand
- ▶ Speed ranges up to 6000 rpm
- ▶ Torque ranges to 240 N-cm
- ▶ All components operate on 115 VAC, 50/60 Hz

### MIXER HEADS

- ▶ Adjustable-tilt mounting assembly permits rotation of mixer head from 0 to 30° for proper positioning of shaft and propeller
- ▶ High-torque, low-speed mixer heads have a keyless chuck; high-speed, low-torque mixer heads have an adjustable through-shaft collet to allow positioning of the mixing propeller at any depth without moving the mixer head

### DRIVE CONTROLS

- ▶ Solid-state controller offers precise speed control with a 100:1 adjustment range
- ▶ Separate FORWARD/OFF/REVERSE switch works independently from speed control dial, allowing you to repeat mixer speed settings from one run to the next
- ▶ Electronic control maintains speed regulation better than ±0.2% despite changes in viscosity, temperature, or line voltage
- ▶ Connects to mixer heads via a 1.8-m (6-ft), three-wire cord to protect electronics from hazardous spills or splashes



Stir-Pak® high-speed, low-torque mixer system 50007-32

### REQUIRED SYSTEM COMPONENTS

- 1 Speed controller
- 2 Mixer head
- 3 Shaft
- 4 Propeller
- 5 Clamps, stand and supports

### ORDERING INFORMATION

ISO9001:2008  
CERTIFIED SUPPLIER



2 year warranty

1 Controller		2 Mixer heads				Complete systems
Catalog number	Catalog number	Description	Speed (rpm)	hp	Max torque (N-cm)	Catalog number
HL-50007-00	HL-50007-10	High torque, low speed	2 to 180	50 W	240	HL-50007-12
	HL-50007-20		9 to 900	50 W	49	HL-50007-22
	HL-50007-30	High speed, low torque	23 to 2300	75 W	32	HL-50007-32
	HL-50007-40		60 to 6000	75 W	12	HL-50007-42

### 3 Mixing Shafts

Shafts are 316 stainless steel. All 10 mm (3/8") dia shafts are machined on one end to accept a 8 mm (5/16") bore dia propeller.

Catalog number	Shaft dimensions (dia x L)
HL-04552-20	8 x 305 mm (5/16" x 12")
HL-04552-30	8 x 457 mm (5/16" x 18")
HL-04552-25	10 x 305 mm (3/8" x 12")
HL-04552-35	10 x 457 mm (3/8" x 18")
HL-04552-00	10 x 610 mm (3/8" x 24")
HL-04552-05	10 x 762 mm (3/8" x 30")

HL-17050-03 NIST-traceable calibration with data for mixer

### 4 Propellers

Three-bladed electropolished propellers have 8 mm (5/16") bore diameter.

Catalog number	Overall diameter
HL-04552-40	25 mm (1")
HL-04552-45	38 mm (1 1/2")
HL-04552-50	51 mm (2")
HL-04552-60	76 mm (3")



04552-40



04552-50



04552-60

### 5 Clamps, Stands, and Supports

HL-04552-65 Tank clamp lets you mount a mixer head and a controller support (either model 04552-70 or 04552-75) directly onto an open top drum or container (maximum 38 mm [1 1/2"] wall thickness)

HL-08041-22 Double clamp for mounting the mixer head onto a stand; holds rods up to 22 mm (7/8") dia

HL-04552-80 Support stand has an electropolished cast steel base and 303 SS support rod measuring 737 mm H x 16 mm dia (29"H x 5/8" dia). Both legs of base accept an optional screw-in support rod

HL-04552-85 Optional screw-in support rod for 04552-80 stand

HL-04552-70 Pivot-mount controller support secures on to the controller. A hinged rod lets you adjust the controller for easy access from various angles. Includes a dual-rod clamp

HL-04552-75 Controller support platform. Mount your controller adjacent to your mixer head. Rack-mount 13 mm (1/2") dia rod fits into a dual-rod clamp (included) or use with our tank clamp 04552-65 (sold above)

## L/S® DIGI-STAL TIC® MODULAR DISPENSING PUMP SYSTEMS

### FEATURES/BENEFITS

- ▶ Deliver flow rates from 0.72 to 5800 mL/min
- ▶ Simultaneously control up to four drives— from one controller or PC workstation
- ▶ Transfer four fluids at the same flow rate or vary each independently
- ▶ Two stacked Easy-Load® II pump heads (included) with offset rollers eliminate pulsation
- ▶ Use as stand-alone system or with PC
- ▶ Ideal for accurate dispensing, diluting, or general fluid transfer
- ▶ Save up to 30 programs into memory; no reprogramming once application is set up
- ▶ No calibration needed with volume changes
- ▶ Input volumes, flow rates, and speed range on 20-key keypad
- ▶ Two sets of NO/NC contacts—“pump running” and “cycle running” signaling at each drive
- ▶ Built-in direct connection and control to Ohaus®, Sartorius®, A & D®, and Mettler Toledo® balances



Digi-Staltic system 77310-00 includes controller, drive, dispensing handle, software (see page 100), and two Easy-Load® II pump heads (77200-62).

### DISPENSING/DILUTING

- ▶ Dispense volumes 0.5 mL to 8000 L
- ▶ Cycles: 1 to 999
- ▶ Interval delay time: 0.1 sec to 167 min in 0.1-second increments
- ▶ Dilute sizes: Sample: 0.1 mL to 100.0 mL; Delivery: 0.1 mL to 8000 L
- ▶ Programmable anti-drip feature
- ▶ Audible prompt after completed dispense cycles (immediate to 60 seconds)

### COMPUTER COMPATIBILITY

- ▶ All Digi-Staltic pump functions can be controlled through a PC workstation
- ▶ Windows®-compatible CD-ROM software included with each drive—see page 100 for details

### SETUP

1. Mount heads, load correct tubing size.
2. Turn on pump drive(s).
3. Select dispense or dilute mode.
4. Input tubing size and select flow rate.
5. Select pumping direction, press ENTER.

### REMOTE CONTROL

- ▶ Remote via contact closure on each drive
- ▶ ON/OFF control with dispensing handle (included) or optional foot switch (07595-40)

### DRIVE CONTROLS

- ▶ Power switch on front of each drive
- ▶ Lighted display indicates power is on
- ▶ Simple, push-button programming:
  - ◆ SPEED/VOLUME      ◆ STOP ALL
  - ◆ ENTER                ◆ PUMP #
  - ◆ BACK                 ◆ CANCEL/STOP
  - ◆ ARROWS (▲)†

ISO9001:2008  
CERTIFIED SUPPLIER

UL US

CE 2 year warranty

### ORDERING INFORMATION

Catalog number	rpm	Power, 50/60 Hz
<b>For L/S Precision tubing</b>		
<a href="#">HL-77340-00</a>	6 to 600	Selectable†† 90 to 130 and 180 to 260 VAC
<b>For L/S High-performance precision tubing</b>		
<a href="#">HL-77310-00</a>	6 to 600	Selectable†† 90 to 130 and 180 to 260 VAC

†Used to select dispense, dilute, and general transfer programs, and to choose options during programming.

††Operates on 115 VAC or 230 VAC; drive is switch-selectable to meet specific needs.

### L/S PUMP TUBING FLOW RATE INFORMATION (mL/MIN)†

Order Masterflex L/S pump tubing separately on pages 68–73.

Tubing cross section	L/S Precision pump tubing						L/S High-performance Precision pump tubing			
	L/S 13	L/S 14	L/S 16	L/S 25	L/S 17	L/S 18	L/S 15	L/S 24	L/S 35	L/S 36
Flow range @ 6 to 600	0.72 to 72	2.6 to 260	9.6 to 960	20 to 2000	34 to 3400	46 to 4600	20 to 2000	34 to 3400	46 to 4600	58 to 5800

†Based on the use of two Easy-Load II pump heads; flow rate depends on tubing size.



### SPECIFICATIONS for L/S Digi-Staltic Modular Dispensing Pumps

Catalog number		HL-77340-00	HL-77310-00
<b>Performance Specifications</b>			
Flow capacity	0.72 to 4600 mL/min (0.012 to 73 GPH)	20 to 5800 mL/min (0.32 to 92 GPH)	
rpm	6 to 600		
Number of heads accepted	2 (included)		
Max torque	Starting	19.4 kg-cm (270 oz-in)	
Max torque	Running	12.9 kg-cm (180 oz-in)	
Reversible	Yes		
External control – Input	Start/Stop +5 VDC, 5 mA		
External control – Output	28 VAC/VDC, 1 A		
<b>Electrical Specifications</b>			
Voltage/Frequency VAC (50/60 Hz)	Drives are switch-selectable: 90 to 130 or 180 to 260 VAC		
Current	1.5 A at 90 to 130 VAC; 0.75 A at 180 to 260 VAC		
Fuse rating	3.15 A / 250 V		
Motor type	Continuous-duty TENV <sup>†</sup> , permanent-magnet DC		
Motor size	75 W (1/10 hp)		
Display	Eighty character, 2-line LCD		
Motor/speed control type	Membrane keypad/microprocessor		
Speed regulation (repeatability)	±0.3%		
Soft start/Electronic brake	Yes/No		
<b>Physical Specifications</b>			
Housing materials	Steel drive and steel controller enclosure, painted finish		
IP rating <sup>‡</sup>	IP22		
Agency listings	UL, cUL, CE		
Operating temperature	0 to 40°C (32 to 104°F)		
Storage temperature	-25 to 65°C (-13 to 149°F)		
Dimensions (L x W x H)	Controller	16.5 x 22.6 x 6.9 cm (6½" x 9" x 2¾")	
	Drive	31.7 x 23.4 x 18.3 cm (12½" x 9¼" x 7¼")	
Shipping weight	13.7 kg (30 lb)		

<sup>†</sup>Totally enclosed, nonventilating. <sup>‡</sup>See page 194 for an explanation of IP ratings.

### ACCESSORIES

**HL-77340-50 Add-on Digi-Staltic dispensing drive** for Precision tubing includes drive and two 77200-60 Easy-Load II pump heads.

**HL-77310-50 Add-on Digi-Staltic dispensing drive** for High-performance precision tubing includes pump drive and two 77200-62 Easy-Load II pump heads.

**HL-77095-03 RJ-12 Cord/cable 3 m (10 ft)**, for connecting drive to controller (1-m [3½-ft] cord included with each drive).

**HL-77095-04 RJ-12 Cord/cable 4.6 m (15 ft)**, for connecting drive to controller (1-m [3½-ft] cord included with each drive).

**HL-77310-01 Replacement Digi-Staltic drive** (drive only). Use one or two pump heads per drive.

**HL-77310-02 Replacement Digi-Staltic controller** (controller only).

**HL-07595-40 Foot switch**, momentary start/stop, 1.8-m (6-ft) cable.

**HL-77310-03 Tubing weights of PTFE**, flow-through type. Keep tubing in place during dispense cycle; insert into end of tubing and place in receiving vessel. Set of two: one for L/S 16, L/S 15, and L/S 25 size tubing; and one for L/S 17, L/S 18, L/S 24, L/S 35, and L/S 36 size tubing.

### REDUCED PULSATION

Minimal pulsation ensures accuracy in peristaltic dispensing. Pulsation causes variations in flow rate and splashing and frothing in the receiving vessel. Combining the split-channel tubing configuration with the offset rollers of two stacked Easy-Load II pump heads merges a pulse from one channel with a trough from the other. The reduced pulsation is measured at the outlet and shown in the graph.



### Dimensional Drawings cm (in.) 77310-00 and 77340-00

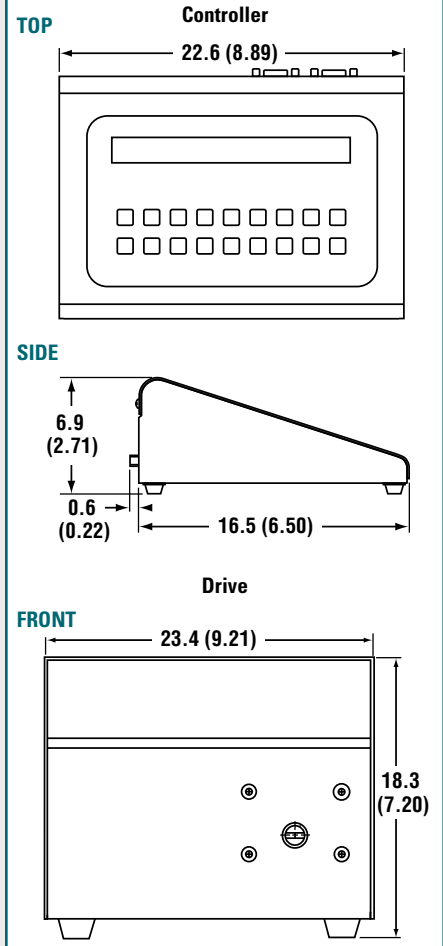

### DISPENSING PRECISION

For all Easy-Load II pump heads

Tubing size	Minimum dose (for ±0.5% precision)	Precision (±)
L/S 13	3 mL	15 µL
L/S 14	11 mL	55 µL
L/S 16	40 mL	200 µL
L/S 25	84 mL	420 µL
L/S 17	140 mL	0.7 mL
L/S 18	200 mL	1 mL
L/S 15	84 mL	420 µL
L/S 24	140 mL	0.7 mL
L/S 35	200 mL	1 mL
L/S 36	240 mL	1.2 mL

L/S\* PUMP HEADS.....38-67

L/S\* TUBING .....68-73

L/S\* PUMP SYSTEMS .....108-117

ACCESSORIES.....160-171

TECHNICAL DATA.....172-206

## LS® DIGI-STALTIC® SOFTWARE AND BALANCE CAPABILITIES

### PROGRAM AND CONTROL YOUR DIGI-STALTIC PUMP SYSTEM FROM YOUR PC

#### Dispense, Dilute, and Transfer

Masterflex® CD-ROM software is included with each Digi-Staltic dispensing pump system. The software, compatible with Windows® 95/98/NT/2000/XP, enables you to save up to 30 fluid handling programs—any combination of dispense, dilute, or general transfer. Also, it allows you to download new programs to the controller created on your computer; download existing programs on the computer to the controller; upload programs from the controller to make revisions; calibrate pumps from the computer; and review feedback of pump activity on the computer screen.

### TYPE OF PROGRAMS

#### Dispensing

This program dispenses a specific volume at a programmed rate with a delay between cycles. The cycle can be automatic or manual. To program for dispensing, determine:

- ▶ Number of pump heads
- ▶ Tubing size
- ▶ Flow rate
- ▶ Volume
- ▶ Pump direction

Optional parameters include acceleration and deceleration times, anti-drip system, cycle, auto/manual, delay, beep, units of measure, as-well as balance and PC interface.

#### Diluting

As a diluter, the pump is first primed. Then, a dilute cycle consists of two separate actions—sample and delivery. For diluting, select the following:

- ▶ Number of pump heads
- ▶ Tubing size
- ▶ Flow rate
- ▶ Sample delivery
- ▶ Pump direction

Optional parameters: anti-drip system, hold, acceleration and deceleration times, cycle, auto/manual, delay, beep, and PC interface.

#### General Transfer

A pump program runs continuously at a programmed rate until the CANCEL/STOP or STOP ALL keys are pressed. For general transfer, choose the following parameters:

- ▶ Number of pump heads
- ▶ Tubing size
- ▶ Flow rate

Optional parameters: anti-drip system, acceleration and deceleration times, pump direction, and PC interface.



This CD-ROM software is included with the Digi-Staltic dispensing systems (77310- and 77340-series). Order on pages 98–99.

### PROGRAM PARAMETERS

**Program Type:** Pump, dispense, dilute

**Tubing Size:** Size depends on application.

**Flow Rate:** Software calculates flow range for tubing size selected.

**Flow Unit:** Choose from mL/min or LPM

**Flow Direction:** Default direction is CW; in dilute program, sample phase direction is opposite of dilute phase direction.

**Acceleration Time:** Amount of time to reach programmed speed (0 to 9.9 sec)

**Deceleration Time:** Amount of time for pump to reach zero from programmed speed (0 to 9.9 sec)

**Anti-Drip:** Reverse pump direction before stopping to prevent dripping (0 to 10; 10=1 revolution).

**Beep Length:** End of cycle alert can be programmed from 0 to 60 seconds.

**Use Balance:** Enables balance use in dispense mode

**Continuous Cycling:** Program continues until the programmed number of cycles is completed.

**Dispense Amount:** Volume to be dispensed (0.5 mL to 8000 L)

**Dispense Unit:** Select units; if balance is selected, unit is set to grams.

**Number of Cycles:** Number of cycles (single dispense or sample and delivery sequence) to be dispensed (1 to 999)

**Program Cycles:** Automatic or manual

**Delay Between Cycles:** Enter delay between cycles in Automatic program (0 to 999.9 sec)

**Delivery Amount:** Equals sample volume and diluent volume

**Delivery Unit:** mL, L; g and kg for dispense

**Sample Amount:** Enter sample volume

**Sample Delay:** Enter delay time between end of the sampling phase and the beginning of the diluent delivery phase.

### Compatibility with Balances

For dispensing applications, the Digi-Staltic® pump controller features a connection to an electronic balance RS-232 cable. A built-in connection and control to Ohaus®, Sartorius®, and A&D® balances eliminates the need to program the controller to read these balances. The Digi-Staltic® pump provides communication through a nine-pin male RS-232 DTE port, and communicates at 9600 baud, 7 databits, 2 stop bits, odd parity.



**Balance Interface Cables** are 1.8 m (6 ft) in length; use for connecting Digi-Staltic controller to noted balances.

Catalog number	Description
<a href="#">HL-77310-06</a>	Cable for Ohaus and Sartorius balances
<a href="#">HL-77310-07</a>	Cable for A&D balances



### L/S VARIABLE-SPEED AIR-POWERED DRIVE



L/S variable-speed air-powered drive 07569-00 with L/S Easy-Load® pump head 07518-42

ISO9001:2008  
CERTIFIED SUPPLIER



ATEX  
Zone 2

2 year  
warranty

### ORDERING INFORMATION

Catalog number	rpm	Power
<a href="#">HL-07569-00</a>	60 to 600	0.08 to 0.7 m <sup>3</sup> /min (3 to 25 cfm) @ 1.4 to 6.9 bar (20 to 100 psi)

### SPECIFICATIONS

Catalog number	<a href="#">HL-07569-00</a>	
<b>Performance Specifications</b>		
Flow capacity	3.6 to 3400 mL/min (0 to 54 GPH)	
rpm	60 to 600	
Number of heads accepted	2	
Maximum torque	Starting	381 N-cm (540 oz-in)
	Running	127 N-cm (180 oz-in)
<b>Electrical Specifications</b>		
Motor type	Rotary vane air motor	
Motor size	250 W (1/2 hp)	
Speed regulation (repeatability)	±10% (±15 rpm @ 60 to 150 rpm; ±20 rpm @ 150 to 600 rpm)	
<b>Physical Specifications</b>		
Housing material	Painted steel	
IP rating <sup>†</sup>	IP44	
Agency listings	CE	
Operating temperature	0 to 40°C (32 to 104°F)	
Storage temperature	-10 to 65°C (14 to 149°F)	
Dimensions (L x W x H)	25.1 x 12.2 x 22.4 cm (9 7/8" x 4 13/16" x 8 13/16")	
Shipping weight	6.0 kg (13.2 lb)	

<sup>†</sup>See page 194 for an explanation of IP ratings.

### FEATURES/BENEFITS

- ▶ Deliver flow rates from 3.6 to 3400 mL/min
- ▶ Ideal for locations where electrical power may be unsafe or impractical
  - ◆ Intrinsically safe when properly grounded for static electricity
  - ◆ No electric power required
- ▶ Wide flow control range (10:1 turndown)
- ▶ Compact, portable console package
- ▶ ATEX Zone 2 rated: EEx II 3 G C II C T6; NEC Class 1, Division 2, Groups A, B, C, D, T6

### SETUP

1. Install 0 to 30 psi pressure gauge, pressure regulator with 5-µm filter, automatic lubricator, and muffler (all items included).
2. Connect compressed air line to 1/4" NPT(F) connection on regulator.
3. Mount pump head and load Masterflex L/S pump tubing.
4. Turn on compressed air line.

**Air hose and compressor are not included.**

### PUMP HEADS ACCEPTED

▶ Drive accepts nine different types of L/S pump heads:

Standard Easy-Load® 3	High-Performance PTFE-Tubing
Easy-Load II	Multichannel
Easy-Load	Multichannel cartridge
PTFE-Diaphragm	

### Dimensional Drawings cm (in.) 07569-00

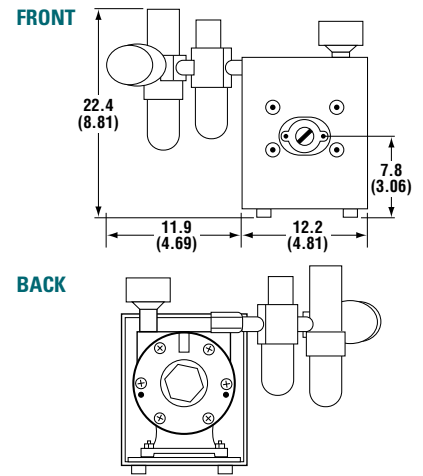

### L/S PUMP TUBING FLOW RATE INFORMATION (mL/MIN)

Order Masterflex L/S pump tubing separately on pages 68–73.

Tubing cross sections	L/S Precision pump tubing						L/S High-performance Precision pump tubing			
	L/S 13	L/S 14	L/S 16	L/S 25	L/S 17	L/S 18	L/S 15	L/S 24	L/S 35	L/S 36
Flow range @ 60 to 600 rpm	3.6 to 36	13 to 130	48 to 480	100 to 1000	170 to 1700	230 to 2300	100 to 1000 (110 to 1100)	170 to 1700 (180 to 1800)	230 to 2300 (260 to 2600)	290 to 2900 (340 to 3400)

**Note:** Flow rates were determined using water at room temperature and with zero back pressure and suction lift. Flow rates in parentheses can be obtained only with the Masterflex L/S High-performance pump head.

## L/S® VARIABLE-SPEED HAZARDOUS-DUTY DRIVE

### FEATURES/BENEFITS

- ▶ Flow rates from 0.6 to 2500 mL/min (0.06 to 11.5 LPM using I/P® pump heads)
- ▶ 115 VAC motor: UL-listed for Class 1, Groups C and D, Division 1 hazardous locations
- ▶ Ideal for areas that require special electrical precautions

### SETUP

1. Mount L/S or I/P pump head to mounting plate.
2. Load Masterflex® L/S or I/P tubing.
3. Turn pump on.

**Power switch and line cord are not included.**

### SPEED CONTROL/CIRCUITRY

- ▶ Mechanical speed control (zero-max) with lever
- ▶ Locking knob to maintain speed control

### PUMP HEADS ACCEPTED

- ▶ Drive accepts 11 different pump heads:
  - ◆ L/S pump heads: Standard, Easy-Load® 3, Easy-Load II, Easy-Load, High-Performance, PTFE-Tubing, Multichannel Cartridge, PTFE-Diaphragm
  - ◆ I/P pump heads: Standard, Easy-Load, High-Performance
- ▶ For flow rate information using I/P pump heads, see page 144

### ORDERING INFORMATION

Catalog number	rpm	Power
<a href="#">HL-07583-50</a>	10 to 430	115 VAC, 60 Hz



**I/P Variable-speed hazardous-duty drive 07583-50 with I/P Easy-Load® pump head 77601-00**

**Variable-speed hazardous-duty drive 07583-50 with L/S Easy-Load® II pump head 77200-62**



### SPECIFICATIONS for L/S Variable-Speed Hazardous-Duty Drive

Catalog number	<a href="#">HL-07583-50</a>	
<b>Performance Specifications</b>		
Flow capacity†	0.6 to 2500 mL/min	
rpm	10 to 430	
Number of heads accepted	2	
Maximum torque	Starting	572 N-cm (810 oz-in)
	Running	191 N-cm (270 oz-in)
Reversible	No (CCW from front)	
<b>Electrical Specifications</b>		
Voltage/Frequency VAC (Hz)	115 (60)	
Current	4.7 A	
Motor type	1725 rpm AC	
Motor size	190 W (¼ hp)	
Motor/speed control type	Mechanical (zero-max) with lever	
<b>Physical Specifications</b>		
Housing materials	Painted steel	
IP rating‡	IP21	
Dimensions (L x W x H)	56.0 cm x 34.6 cm x 22.3 cm (22 1/16" x 13 5/8" x 8 3/4")	
Operating temperature	0 to 40°C (32 to 104°F)	
Storage temperature	-25 to 65°C (-13 to 149°F)	
Shipping weight	26.6 kg (58.6 lb)	

†Depending on drive rpm and tubing size. ‡See page 194 for an explanation of IP ratings.

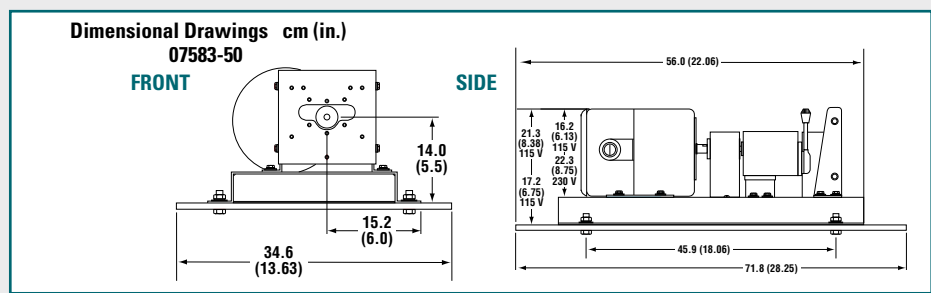

### L/S PUMP TUBING FLOW RATE INFORMATION (mL/MIN)

Order Masterflex L/S pump tubing separately on pages 68–73.

Tubing sizes	L/S Precision pump tubing						L/S High-performance Precision pump tubing			
	L/S 13	L/S 14	L/S 16	L/S 25	L/S 17	L/S 18	L/S 15	L/S 24	L/S 35	L/S 36
Flow range @ 10 to 430 rpm	0.6 to 26	2.1 to 86	8 to 350	17 to 730	28 to 1200	38 to 1600	17 to 730 (18 to 780)	28 to 1200 (30 to 1300)	38 to 1600 (43 to 1900)	48 to 2100 (58 to 2500)

**Note:** Flow rates were determined using water at room temperature and with zero back pressure and suction lift. Flow rates in parentheses can be obtained only with the Masterflex L/S High-performance pump head.





## L/S NEMA TYPE 56C PUMP HEAD ADAPTERS

### FEATURES/BENEFITS

- Deliver flow rates up to 3400 mL/min with Masterflex® L/S pump heads
- Attach your own special motor to meet local electrical standards, hazardous-duty requirements, or washdown requirements
- Multichannel capabilities

### SELECTION CRITERIA

- Determine flow rate/gear ratio required. (You must select a gear ratio that will keep pump head speed from exceeding 600 rpm.)

To calculate nominal flow rate (use "Flow Rate" table to obtain values):

$$\frac{\text{motor rpm}}{\text{gear ratio}} \times \frac{\text{flow per revolution}}{\text{revolution}} = \text{flow rate}$$

### SETUP

- Slide shaft adapter over motor shaft and tighten set screws with hex wrench.
- Position housing over shaft adapter.
- Attach housing to motor with four bolts (supplied).
- Mount pump head and load L/S tubing.
- Turn pump on.

### PUMP HEADS ACCEPTED

- Accepts nine different pump heads:
  - Standard
  - Easy-Load® 3
  - Easy-Load II
  - Easy-Load
  - High-Performance
  - PTFE-Tubing
  - Multichannel
  - Multichannel cartridge
  - PTFE-Diaphragm

### MOTOR SPECIFICATIONS

- Use a ¼-hp motor or larger
- Go to [www.coleparmer.com/motors](http://www.coleparmer.com/motors) for additional motor options and for VFD controllers to vary the speed of the motors listed below right
- Select fixed or variable speed; TEFC (IP44), washdown (IP56), or hazardous-duty; AC or DC; 50, 60, or 50/60 Hz



**77495-00 pump head adapter (middle, above) shown with 07518-10 Easy-Load® pump head and 02631-00 motor, each sold separately. Adapter includes hardware.**

### SPECIFICATIONS for L/S Pump Head Adapters

Catalog number	<a href="#">HL-77495-00, -20</a>
<b>Performance Specifications</b>	
Flow capacity	0.06 to 3400 mL/min (0 to 54 GPH)
Number of heads accepted	Up to 2
<b>Physical Specifications</b>	
Construction material	Painted aluminum
IP rating†	IP34 with gasket (included) mounted to motor
Operating temperature	0 to 40°C (32 to 104°F)
Storage temperature	-25 to 65°C (-13 to 149°F)
Dimensions (L x W x H)	14.6 x 16.5 x 16.5 cm (5¾" x 6½" x 6½")
Shipping weight	6.0 kg (13.2 lb)

†See page 194 for an explanation of IP ratings.

ISO9001:2008  
CERTIFIED SUPPLIER

2 year  
warranty

### ORDERING INFORMATION

Catalog number	Gear ratio	Max motor rpm	Max torque kg-cm (oz-in)
<a href="#">HL-77495-00</a>	3.7:1	2220	12 (170)
<a href="#">HL-77495-20</a>	18.3:1	3450	15 (210)

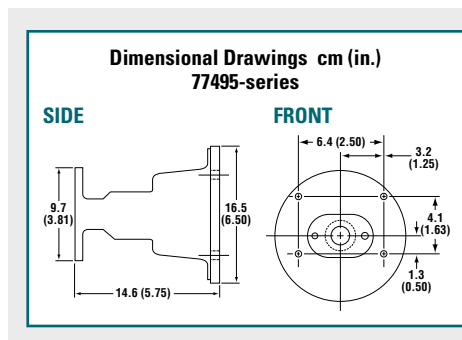

### DC MOTORS WITH 56C FRAME

Cat. no.	hp	Wattage	rpm	Type†	Voltage	IP rating†	Overall dimensions (L x W x H)
<a href="#">HL-70072-00</a>	¼	225	1800	TENV	12 VDC	IP44	23.2 x 16.5 x 17.1 cm (9¼" x 6½" x 6¾")
<a href="#">HL-70074-00</a>	⅓	248	1800	XPRF	90 VDC	IP55	26.5 x 16.5 x 17.1 cm (10⅜" x 6½" x 6¾")
<a href="#">HL-70073-00</a>	¼	225	1750	WDN	90 VDC	IP56	28.6 x 16.5 x 17.5 cm (11¼" x 6½" x 6⅞")

†TENV—Totally enclosed, nonventilating TEFC—Totally enclosed, fan-cooled WDN—Washdown XPRF—Explosion proof †See page 194 for an explanation of IP ratings.

### L/S PUMP TUBING FLOW RATE INFORMATION (mL/MIN)

Order Masterflex L/S pump tubing separately on pages 68–73.

Recommended motor rpm limits	Adapter gear ratio	Pump head rpm	L/S Precision pump tubing						L/S High-performance Precision pump tubing			
			L/S 13	L/S 14	L/S 16	L/S 25	L/S 17	L/S 18	L/S 15	L/S 24	L/S 35	L/S 36
Flow per revolution			0.06	0.21	0.8	1.7	2.8	3.8	1.7 (1.8)	2.8 (3.0)	3.8 (4.3)	4.8 (5.8)
3.7 to 2220	3.7:1	1 to 600	0.06 to 36	0.21 to 130	0.8 to 480	1.7 to 1000	2.8 to 1700	3.8 to 2300	1.7 to 1000 (1.8 to 1100)	2.8 to 1700 (3.0 to 1800)	3.8 to 2300 (4.3 to 2600)	4.8 to 2900 (5.8 to 3400)
18.3 to 3450	18.3:1	1 to 190	0.06 to 12	0.21 to 40	0.8 to 150	1.7 to 320	2.8 to 540	3.8 to 720	1.7 to 320 (1.8 to 340)	2.8 to 540 (3.0 to 580)	3.8 to 720 (4.3 to 800)	4.8 to 900 (5.8 to 1100)

Note: Flow ranges are approximate—calculated under the following conditions: 0 psig at inlet and outlet; water temperature at 22°C (72°F). Flow rates in parentheses obtainable with High-Performance pump head.

## E/S® PORTABLE SAMPLING DRIVE

### FEATURES/BENEFITS

- ◆ Floats up to 30 minutes if dropped in water when case is closed and latched
- ◆ IP54-rated control panel protects against inclement weather and splashing water
- ◆ High-visibility housing for easy recovery
- ◆ Can be used in the field for sampling or in the plant as a portable pump
- ◆ Flow rate: 4.2 to 1100 mL/min depending on tubing size used
- ◆ Sample depths to 7.9 m (26 ft)<sup>†</sup>
- ◆ Reversible flow and prime/purge function
- ◆ Use it even where there is no electrical power
- ◆ Sealed and self-contained 12 VDC rechargeable battery provides up to four hours of nonstop operation in the field
- ◆ Convenient battery-status indicator
- ◆ Operate on internal batteries, 12 V car battery, or AC outlet
- ◆ Variable-speed motor; 400 rpm max

### PUMP HEADS ACCEPTED

- ◆ Accepts three Masterflex® L/S® pump head types: Standard, Easy-Load®, or PTFE-Tubing

### DRIVE CONTROLS

- ◆ Single-turn potentiometer for speed control
- ◆ ON indicator illuminates when internal batteries are fully charged
- ◆ Three position power/reversing switch
- ◆ Purge and fill via CW/CCW direction toggle switch

### SETUP

1. Load pump head with Masterflex L/S precision tubing (use L/S 15 or L/S 24 C-FLEX® or silicone tubing for optimal performance).
2. Mount head to drive.
3. Select power source.
4. Turn drive on.
5. Adjust for desired flow or sample rate.

<sup>†</sup>Maximum sampling depth can be achieved with either a L/S 15 or L/S 24 Standard pump head.



E/S portable sampling drive 07571-00 with Easy-Load pump head 07518-02



### ORDERING INFORMATION

Catalog number	rpm	Power (50/60 Hz)
<a href="#">HL-07571-00</a>	70 to 400	115 VAC
<a href="#">HL-07571-05</a>		230 VAC

### ACCESSORIES

[HL-07570-04](#) Flow-through tubing weight, SS. Prevents curling or floating. Fits L/S 15, L/S 24, and L/S 25 tubing.

[HL-07571-50](#) Cigarette lighter adapter, with 7.6-m (25-ft) cable.

[HL-07571-52](#) Auxiliary power kit for 07571-00 drive; 12 VDC. Includes cable to connect to external power supply input.

### L/S PUMP TUBING FLOW RATE INFORMATION (mL/MIN)

Order Masterflex L/S pump tubing separately on pages 68–73.

Tubing cross sections	L/S Precision pump tubing						L/S High-performance Precision pump tubing	
	L/S 13	L/S 14	L/S 16	L/S 25	L/S 17	L/S 18	L/S 15	L/S 24
Flow range @ 70 to 400 rpm	4.2 to 24	15 to 84	56 to 320	120 to 680	Not recommended		120 to 680	200 to 1100

**STANDARD**  
4.2 to 320 mL/min  
pages 40–41



**EASY-LOAD®**  
4.2 to 1100 mL/min  
pages 46–47



**PTFE-TUBING**  
0.06 to 65 mL/min  
pages 50–51

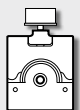



### SPECIFICATIONS for E/S Portable Sampling Drive

Catalog number	<a href="#">HL-07571-00</a>	<a href="#">HL-07571-05</a>
<b>Performance Specifications</b>		
Flow capacity	4.2 to 1100 mL/min (0.06 to 17.4 GPH)	
rpm	70 to 400	
Number of heads accepted	1	
Reversible	Yes	
External control – Input/Output	Not applicable	
<b>Electrical Specifications</b>		
Voltage/Frequency VAC (Hz) <sup>†</sup>	115 (50/60)	230 (50/60)
Current	0.25 A	0.125 A
Motor type	Permanent-magnet DC	
Motor size	37 W (½ hp)	
Motor/speed control type	Solid state	
Speed regulation (repeatability)	±5% (±5%)	
Soft start/Electronic brake	No	
<b>Physical Specifications</b>		
Housing materials	HDPE, anodized aluminum, stainless steel, and polyester	
IP rating <sup>‡</sup>	IP54	
Agency listings	CE, (power supplies are UL, cUL)	
Operating temperature	0 to 40°C (32 to 104°F)	
Storage temperature	-25 to 65°C (-13 to 149°F)	
Humidity limits	10 to 90% noncondensing	
Dimensions (L x W x H)	27.9 x 25.4 x 40.6 cm (11" x 10" x 16")	
Shipping weight	8.7 kg (16 lb)	

<sup>†</sup>Also runs on internal battery or 12 VDC external source.

<sup>‡</sup>See page 194 for an explanation of IP ratings)



**When closed and latched, E/S portable sampling pump will float up to 30 minutes if dropped in water.**

### MORE INFO

Our FREE Tubing Test Kit is a simple way to test your chemicals against different tubing formulations. Kit contains samples of different pump tubing formulations, formulation descriptions, a selection guide, instructions on how to test your tubing, and complete ordering information. Request item HL-00101-10.



### FOR THE LATEST...

**Masterflex technical resources, see**

- [ColeParmer.com](#)
- [Masterflex.com](#)

L/S\* PUMP HEADS.....38-67  
 L/S\* TUBING .....68-73  
 L/S\* PUMP SYSTEMS .....108-117

ACCESSORIES .....160-171

TECHNICAL DATA.....172-206

### COMPLETE L/S PTFE-TUBING PUMP SYSTEM

#### Applications

- ▶ Pumping high-purity fluids
- ▶ Transfer of aggressive chemicals
- ▶ Chemical feed and metering
- ▶ Filtration

#### Benefits

- ▶ Flow rate: 0.75 to 65 mL/min; pressure up to 100 psi (6.9 bar)
- ▶ Low-pulsation, six-roller pump head
- ▶ Continuous-duty drive displays speed (rpm) and direction

**Complete system includes:** L/S PTFE tubing pump head 77390-00, 6-mm OD PTFE tube set 77390-60, L/S 300 rpm variable-speed console drive 07528-20, and two ¼" NPT(M) pipe adapters.



Drive is

Catalog number	Power
<a href="#">HL-77912-10</a>	90 to 260 VAC, 50/60 Hz

## E/S® COMPOSITE SAMPLER

### FEATURES/BENEFITS

- ▶ Program operation to meet EPA sampling requirements
- ▶ Locking latches prevent tampering and provide buoyancy—latched sampler floats at least 30 minutes if dropped in water
- ▶ IP56-rated control panel protects against inclement weather and splashing water
- ▶ Rechargeable battery makes it ideal for field applications
- ▶ Dual-line, 24-character, backlit adjustable LCD with glow-in-the-dark keypad
- ▶ Capable of standing by for up to 90 days for a remote signal
- ▶ Sample depths to 7.9 m (26 ft)
- ▶ Complete system includes: Masterflex® L/S® Easy-Load® pump head, 9-liter HDPE carboy, 12 VDC battery, 115/230 VAC power adapter/battery recharger, quick-disconnect fittings for inlet and outlet connections, and 7.6 m (25 ft) of L/S 24 peroxide-cured silicone tubing



Power supplies are:



E/S composite sampler 07580-00

### SETUP AND OPERATION

1. Load tubing (L/S 15 or L/S 24 silicone, Tygon® E-LFL, or Tygon® E-Lab).
2. Turn pump on by pressing and holding the Power/Status button until LCD responds.
3. Select menu.
4. Select program.<sup>†</sup>
5. Press Start.

▶ All controls are on the front panel:

**CAL**—sets sample volume calibration mode for accurate sampling volume

**CLOCK**—sets the real time 24-hour clock

**CYCLE TEST**—checks the sampler for correct operation (purge, rinse, draw sample) to verify correct operation

**DELAY START**—for programming additional time before start of the program

**MENU**—accesses menu selections

**PROGRAM**—loads program selection

**SAMPLE VOLUME**—allows for input of desired sample volume into program

**TIME**—for inputting desired time interval into program

<sup>†</sup>Select from six preprogrammed sampler programs; five programs can be customized.



**2 year warranty**

### ORDERING INFORMATION

Catalog number	Description
<a href="#">HL-07580-00</a>	E/S composite sampler

### ACCESSORIES

[HL-07518-12](#) Replacement Easy-Load pump head, for use with sizes L/S 15 and L/S 24 tubing.

[HL-07571-50](#) Automotive adapter, 7.6-m (25-ft) cable.

[HL-77200-07](#) Replacement universal power supply, 115/230 VAC, 3.6-m (12-ft) cable.

[HL-07571-55](#) Replacement battery, 12 VDC.

[HL-06032-20](#) Replacement HDPE carboy, 9 liters.

### LIFT HEIGHT VS TUBING SIZE, FORMULATION, AND FLOW (mL/MIN)

Lift height m (ft)	Tubing size	Flow rate (mL/min) @ 21°C (70°F), 600 rpm		
		Silicone	Tygon E-LFL	Tygon E-Lab
0.3 (1)	L/S 15	1012	1110	1110
3.7 (12)		952	1065	1035
7.6 (25)		435	855	765
0.3 (1)	L/S 24	1627	1650	1650
3.7 (12)		1095	1545	1432
7.6 (25)		4.6 m (15 ft) max lift	1005	840

### SPECIFICATIONS for E/S Composite Sampler

Catalog number	<a href="#">HL-07580-00</a>
<b>Performance Specifications</b>	
Flow capacity	1650 mL/min @ 30.5 cm (1 ft) of suction with L/S 24 Tygon® E-LFL/E-Lab tubing
Sample accuracy	±5% of programmed sample volume or ±5 mL, which is greater
Clock accuracy	±1 minute/month
rpm range	600 fixed speed
Number of heads accepted	1 (one Easy-Load® pump head 07518-12 supplied)
Power	12 VDC sealed rechargeable gel-type batteries or AC with power adapter
External control	Dry contact closure
<b>Physical Specifications</b>	
Housing materials	Polyethylene housing and carboy; nonferrous hardware
IP rating	When case closed: IP56 <sup>‡</sup>
Agency listings	Power supplies are: UL, cUL, CE
Operating temperature	0 to 40°C (32 to 104°F)
Storage temperature	-25 to 65°C (-13 to 149°F)
Dimensions (L x W x H)	28 x 34.3 x 44.4 cm (11" x 13½" x 17½")
Shipping weight	10.9 kg (24 lb)

<sup>‡</sup>See page 194 for an explanation of IP ratings.

[HL-06360-82](#) Replacement quick-disconnect fitting, ¼" hose barb for internal-external tubing connection to pump.

[HL-07570-04](#) Flow-through tubing weight, SS. Prevents curling and floating. Fits L/S 15 and L/S 24 tubing.

[HL-07580-50](#) Carrying strap, optional.

L/S® PUMP HEADS..... 38-67

L/S® TUBING ..... 68-73

ACCESSORIES ..... 160-171

TECHNICAL DATA..... 172-206



### L/S<sup>®</sup> DC-POWERED DRIVES

#### FEATURES/BENEFITS

##### Cabinet-Style Drives

- ▶ Deliver flow rates from 1.2 to 2400 mL/min
- ▶ Ideal for pumping fluids in remote locations
- ▶ Sample depths to 7.9 m (26 ft)<sup>†</sup>
- ▶ Reversible motor
- ▶ Adapt easily to 12 VDC power sources
- ▶ Easily portable with carrying handle
- ▶ Accept Standard, High-Performance, PTFE-tubing, Easy-Load<sup>®</sup>, Easy-Load II, and Easy-Load 3 pump heads

##### Compact Drives

- ▶ Deliver flow rates from 6 to 2700 mL/min
- ▶ Chemical-resistant steel motor housing
- ▶ Perfect for rugged applications that require continuous-duty pumping
- ▶ Adapt easily to 12- or 24-VDC power sources
- ▶ Ideal for OEM applications
- ▶ Accept Standard, Cartridge, PTFE-tubing, PTFE-diaphragm, High-Performance, Easy-Load, Easy-Load II, and Easy-Load 3 pump heads

**Note:** Drives listed in "Specifications" table that accept only one pump head cannot be used with High-Performance or PTFE pump heads.

#### DRIVE CONTROLS

##### Cabinet-Style Drives

- ▶ All manual controls are on front panel
- ▶ Separate single-turn potentiometer speed control and CW/OFF/CCW switch

##### Compact Drives

- ▶ Vary input voltage to change drive speed; reverse input voltage polarity to reverse direction
- ▶ Three-wire, 16-gauge, 30-cm (12") long stripped-end leads for power connection

#### ACCESSORIES

**HL-07573-02 Cigarette lighter adapter cable**, 7.6 m (25 ft). For cabinet-style drives only.

**HL-17050-01 NIST-traceable calibration** for peristaltic pump drive.



L/S compact drive 07533-50



L/S cabinet-style drive 07533-20

#### SPECIFICATIONS & ORDERING INFORMATION for L/S DC-Powered Drives

Catalog number	Cabinet-style drives		Compact drives			
	12 VDC		12 VDC		24 VDC	
	HL-07533-20	HL-07533-40	HL-07533		HL-07533	
			-60	-50	-70	-80
<b>Performance Specifications</b>						
Flow capacity	1.2 to 2400 mL/min (0 to 38 GPH)		6 to 2700 mL/min (0 to 43 GPH)			
rpm	20 to 90	100 to 500	540	100	570	
Number of heads accepted	2	1	2		1	
Maximum torque	127 N-cm (180 oz-in)	64 N-cm (90 oz-in)	127 N-cm (180 oz-in)		64 N-cm (90 oz-in)	
Reversible	Yes					
<b>Electrical Specifications</b>						
Voltage VDC	10.8 to 13.2		1.5 to 15	1 to 15	1 to 30	1.7 to 30
Current	3 A		5.7 A	3.2 A	1.5 A	2.6 A
Motor type	Permanent-magnet, brushed DC					
Motor size	37 W (1/2 hp)					
Motor/Speed control type	Single-turn potentiometer		Not applicable			
Speed regulation (repeatability)	±5%					
Soft-start/Electronic brake	Not applicable					
<b>Physical Specifications</b>						
Housing materials	Painted steel		Painted steel			
IP rating <sup>‡</sup>	IP21		IP52			
Agency listings	CE					
Operating temperature	0 to 40°C (32 to 104°F)					
Storage temperature	-25 to 65°C (-13 to 149°F)					
Dimensions (L x W x H)	27.9 x 16.5 x 22.2 cm (11" x 6 1/2" x 8 3/4")		21.6 x 9.7 x 11.7 cm (8 5/16" x 3 13/16" x 4 5/8")			
Shipping weight	5.3 kg (11.7 lb)		4.1 kg (9 lb)			

<sup>†</sup>Max sampling depth can be achieved with either a size L/S 15 or L/S 24 Standard pump head.  
<sup>‡</sup>See page 194 for an explanation of IP ratings.

#### L/S PUMP TUBING FLOW RATE INFORMATION (mL/MIN)

Order Masterflex L/S pump tubing on pages 68–73.

Tubing cross section	L/S Precision pump tubing						L/S High-performance Precision pump tubing			
	L/S 13	L/S 14	L/S 16	L/S 25	L/S17	L/S 18	L/S 15	L/S 24	L/S 35	L/S 36
Flow range @ 20 to 90 rpm	1.2 to 5.4	4.2 to 19	16 to 72	34 to 150	56 to 250	76 to 340	34 to 150 (36 to 160)	56 to 250 (60 to 270)	76 to 340 (86 to 390)	96 to 430 (116 to 520)
Flow range @ 100 to 500 rpm	6 to 30	21 to 105	80 to 400	170 to 850	280 to 1400	380 to 1900	170 to 850	280 to 1400	380 to 1900	480 to 2400
Flow range @ 100 rpm	6	21	80	170	280	380	170 (180)	280 (300)	380 (430)	480 (580)
Flow range @ 540 rpm	32	113	430	920	1500	2050	920	1500	2050	2600
Flow range @ 570 rpm	34	120	450	970	1600	2170	970	1600	2170	2700

**Note:** Flow rates in parentheses can be obtained only with Masterflex L/S High-Performance pump heads.

## L/S® ECONOMY PUMP SYSTEMS

### APPLICATIONS

- General fluid transfer
- Filtration
- Low-pressure chromatography
- Fermentation

### FEATURES

- Soft-start, 1/20-hp continuous-duty drive
- ±5% drive speed accuracy
- Stackable painted-steel console housing

### BENEFITS

- Versatile system with a wide flow range
- Easy tubing changes
- Most economical L/S pump system
- Self-priming



77910-30



77910-20

### SPECIFICATIONS & ORDERING INFORMATION

ISO9001:2008  
CERTIFIED SUPPLIER

UL US CE 2 year warranty

Catalog number	Flow range† (mL/min)	Pump head included	Tubing included	Tubing sizes accepted	Drive included	Drive speed range (rpm)	Drive IP rating	Power (50/60 Hz)
<a href="#">HL-77910-30</a>	16 to 480	L/S Easy-Load® 3 77800-60	C-Flex® ULTRA L/S 16 06434-16; 3 m (10 ft)	L/S 13, L/S 14, L/S 16, L/S 25, L/S 17, L/S 18	07554-90	20 to 600	IP23	90 to 130 VAC, 1.5 A
<a href="#">HL-77910-35</a>					07554-95			180 to 260 VAC, 0.8 A
<a href="#">HL-77910-20</a>	56 to 1700	L/S Easy-Load II 77200-62	C-Flex ULTRA L/S 24 06434-24; 3 m (10 ft)	L/S 15, L/S 24, L/S 35, L/S 36	07554-90			90 to 130 VAC, 1.5 A
<a href="#">HL-77910-25</a>					07554-95			180 to 260 VAC, 0.8 A

†Flow range with included tubing; extend the flow range of these systems with additional sizes of tubing; order on pages 68-73.

[HL-17050-01](#) NIST-traceable calibration for peristaltic pump drive.

## L/S® PRECISION MODULAR PUMP SYSTEMS

### APPLICATIONS

- Sterile fluid transfer
- Carboy or small tank pumping
- Chemical recirculation
- Printing
- Laboratory research
- Filtration
- Polishing/lapping

### FEATURES

- Controller and chemical-resistant drive connected by 1.8-m (6-ft) cable
- Soft-start, 1/10-hp continuous-duty drive
- ±0.25% speed control



77913-70

### BENEFITS

- Modular format lets you place drive and controller up to 1.8 meters (6 feet) apart
- Easy tubing changes
- Three-digit LED shows motor speed (rpm) for easy repeatability
- Reversible motor lets you purge tubing before or after pumping
- Optional remote control of speed, start/stop, and direction



77913-60

### SPECIFICATIONS & ORDERING INFORMATION

ISO9001:2008  
CERTIFIED SUPPLIER

UL US CE 2 year warranty

Catalog number	Flow range† (mL/min)	Pump head included	Tubing included	Tubing sizes accepted	Drive included	Drive speed range (rpm)	Drive IP rating	Power (50/60 Hz)
<b>Precision modular pumps with benchtop controller</b>								
<a href="#">HL-77913-60</a>	4.8 to 480	L/S Easy-Load® 3 77800-60	C-Flex® ULTRA L/S 16 06434-16; 3 m (10 ft)	L/S 13, L/S 14, L/S 16, L/S 25, L/S 17, L/S 18	07577-00	6 to 600	IP33	90 to 130 VAC, 2.2 A; and 190 to 260 VAC, 1.1 A
<a href="#">HL-77913-70</a>	17 to 1700	L/S Easy-Load II 77200-62	C-Flex ULTRA L/S 24 06434-24; 3 m (10 ft)	L/S 15, L/S 24, L/S 35, L/S 36				
<b>Precision modular pump with washdown wall-mount controller</b>								
<a href="#">HL-77913-80</a>	17 to 1700	L/S Easy-Load II 77200-62	C-Flex ULTRA L/S 24 06434-24; 3 m (10 ft)	L/S 15, L/S 24, L/S 35, L/S 36	07577-60	6 to 600	IP66	90 to 130 VAC, 2.2 A; and 190 to 260 VAC, 1.1 A

†Flow range with included tubing; extend the flow range of these systems with additional sizes of tubing; order on pages 68-73.



## L/S<sup>®</sup> PRECISION ANALOG CONSOLE PUMP SYSTEMS

### APPLICATIONS

- ▶ General transfer and metering
- ▶ Circulating bath pump
- ▶ Remote-controlled metering pump
- ▶ Acid-base feed
- ▶ Low-pressure filtration
- ▶ Small tank transfer and filling

### BENEFITS

- ▶ Simple keypad controls offer operational ease
- ▶ Powerful and cost-effective pump for precision transfer and metering applications
- ▶ Control pump speed remotely with 4 to 20 mA or 0 to 10 V signal
- ▶ Three-digit LED shows motor speed (rpm) for repeatability and monitoring performance
- ▶ Reversible motor—prime/purge and easily reverse direction of flow

### FEATURES

- ▶ PWM speed control for precision and efficiency; ±0.25% speed control accuracy
- ▶ Stackable ABS housing is IP33 rated for wipedown
- ▶ Universal voltage, 90 to 260 VAC autoselect, 50/60 Hz
- ▶ Soft-start 1/10-hp continuous-duty drive



77916-20



77916-10

### SPECIFICATIONS & ORDERING INFORMATION

ISO 9001:2008  
CERTIFIED SUPPLIER



2 year  
warranty

Catalog number	Flow range <sup>†</sup> (mL/min)	Pump head included	Tubing included	Tubing sizes accepted	Drive included	Drive speed range (rpm)	Drive IP rating	Power (50/60 Hz)
<a href="#">HL-77916-10</a>	4.8 to 480	L/S Easy-Load <sup>®</sup> 3 77800-60	C-Flex <sup>®</sup> ULTRA L/S 16 06434-16; 3 m (10-ft)	L/S 13, L/S 14, L/S 16, L/S 25, L/S 17, L/S 18	07528-10	6 to 600	IP33	90 to 130 VAC, 2.2 A; and 190 to 260 VAC, 1.1 A
<a href="#">HL-77916-20</a>	17 to 1700	L/S Easy-Load II 77200-62	C-Flex ULTRA L/S 24 06434-24; 3 m (10-ft)	L/S 15, L/S 24, L/S 35, L/S 36				

<sup>†</sup>Flow range with included tubing; extend the flow range of these systems with additional sizes of tubing; order on pages 68–73.

[HL-77595-35](#) Foot switch, momentary start/stop; 1.8-m (6-ft) cable.

[HL-07595-45](#) DB9 male connector, use to create your own cable.

[HL-17050-01](#) NIST-traceable calibration for peristaltic pump drive.

[HL-07595-47](#) Cable assembly, DB9 male connector and 7.9 m (25-ft) cable with stripped wire terminal ends. Use for remote control.

[HL-07523-98](#) Tilt bail; use to securely elevate front of drive.

**INNOCAL<sup>®</sup>**  
INNOVATIVE CALIBRATION SOLUTIONS

## Pump Preventive Maintenance Package

*Prevent shutdowns and ensure optimal pump performance*

InnoCal, our service and repair center, offers a Preventive Maintenance Package for our Masterflex<sup>®</sup> L/S<sup>®</sup> Pumps.

### Description of Service:

Experienced, factory-trained technicians perform the following maintenance activities:

- Testing and adjustment of the motor to ensure correct rpm output
- Disassembly of the gearbox and examination of the armature movement
- Replacement of gears/shafts/gaskets
- Application of thermal grease
- Brush holder examination and brush replacement
- Inspection and testing of gear bearings and bushings; replacement as necessary
- Ground wire and safety check
- Asset tagging of the pump with next recommended service date
- Detailed Service Inspection Report unique to instrument by serial #

[HL-17110-00](#) Pump preventive maintenance package

*InnoCal technicians are also trained and equipped to perform Masterflex<sup>®</sup> warranty repair and any other service that may be required due to normal wear and tear.*

**5 Day**  
Turn-Around



**Extend the service life of your Masterflex<sup>®</sup> pumps and protect your valuable investment with an InnoCal Preventive Maintenance Package.**

**Contact an InnoCal Service Technician at 866-INNOCAL (466-6225) to schedule your service today!**

## LS® STANDARD DIGITAL PUMP SYSTEMS

### APPLICATIONS

- Acid/base pH control
- Nutrient media dispensing
- Precision fragrance delivery
- Automated fermentation
- Surfactant delivery
- Accurate metering

### BENEFITS

- Brushless, maintenance-free motor reduces operating costs
- Reversible pumping
- Graphical LCD shows flow rate, rpm, dispense volume, dispense time, copy number, cumulative volume
- Remote control: Start/stop foot switch (order below); 0–20 mA, 4–20 mA, or 0–10 VDC speed control; Start/stop/reverse/prime (with DB25 male connector)
- Programmable flow rate and dispense interval for automated dispensing
- Can be calibrated for greater accuracy

### FEATURES

- 1/10-hp, continuous-duty drive
- ±0.1% drive speed control with tach feedback
- Splash-resistant stackable housing
- Membrane keypad with lockout



77921-75



77921-65

### SPECIFICATIONS & ORDERING INFORMATION

ISO9001:2008 CERTIFIED SUPPLIER   **2 year warranty**

Catalog number	Flow range <sup>†</sup> (mL/min)	Pump head included	Tubing included	Tubing sizes accepted	Drive included	Drive speed range (rpm)	Drive IP rating	Power (50/60 Hz)
<a href="#">HL-77921-65</a>	0.08 to 480	L/S Easy-Load® 3 77800-60	C-Flex® ULTRA L/S 16 06434-16; 3 m (10 ft)	L/S 13, L/S 14, L/S 16, L/S 25, L/S 17, L/S 18	07522-20	0.1 to 600	IP33	90 to 130 VAC, 2.2 A; and 190 to 260 VAC, 1.1 A
<a href="#">HL-77921-75</a>	0.28 to 1700	L/S Easy-Load II 77200-62	C-Flex ULTRA L/S 24 06434-24; 3 m (10 ft)	L/S 15, L/S 24, L/S 35, L/S 36				

<sup>†</sup>Flow range with included tubing; extend the flow range of these systems with additional sizes of tubing; order on pages 68–73.

[HL-07523-92](#) **Foot switch**, momentary start/start, 1.8-m (6-ft) cable.

[HL-07523-97](#) **Dispensing handle** for momentary start/stop.

[HL-07523-95](#) **Cable assembly**, DB25 male connector and 25-ft (7.9-m) cable with stripped wire ends for remote control.

[HL-17050-01](#) **NIST-traceable calibration** for peristaltic pump drive.

## LS® FOUR-CHANNEL DIGITAL DISPENSING PUMP SYSTEM

### APPLICATIONS

- Precision dispensing
- Synchronous multichannel filling
- Metering fluids into multiple containers or outlets
- Filtration

### BENEFITS

- Digital dispensing drive features maintenance-free brushless motor
- Program dispensing parameters—including volume, copy, time, and delay interval—for automated dispensing
- Four-channel, six-roller pump head offers low pulsation and synchronous flow between channels for high accuracy and consistent fills
- BioPharm Plus platinum silicone tubing delivers exceptional flow stability over time making it ideal for dispensing applications

### FEATURES

- 1/10-hp continuous-duty brushless drive; tach feedback for ±0.1% speed control
- Remote control via DB25 female connector on drive
- Membrane keypad with lockout

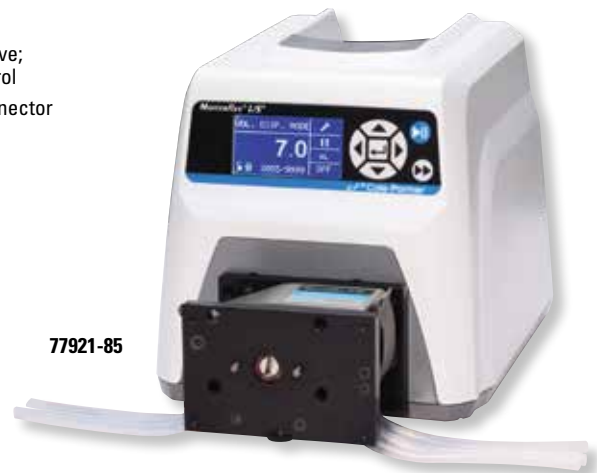

77921-85

### SPECIFICATIONS & ORDERING INFORMATION

ISO9001:2008 CERTIFIED SUPPLIER   **2 year warranty**

Catalog number	Flow range <sup>†</sup> (mL/min)	Pump head included	Tubing included	Tubing sizes accepted	Drive included	Drive speed range (rpm)	Drive IP rating	Power (50/60 Hz)
<a href="#">HL-77921-85</a>	0.047 to 280	L/S Four-channel 07535-04	BioPharm Plus silicone tube set, L/S 16 96116-16; pk of 8	L/S two-stop tube sets: L/S 13, L/S 14, L/S 16	07522-20	0.1 to 600	IP33	90 to 130 VAC, 2.2 A; 190 to 260 VAC, 1.1 A

<sup>†</sup>Flow range per channel with included tubing; extend the flow range of this system with additional sizes of tubing; order L/S two-stop tube sets on page 55.

[HL-07523-92](#) **Foot switch**, momentary start/start, 1.8-m (6-ft) cable.

[HL-07523-94](#) **DB25 Connector**. Use to create your own cable.

[HL-07523-97](#) **Dispensing handle** for momentary start/stop.





## L/S® COMPUTER-COMPATIBLE PUMP SYSTEMS

### APPLICATIONS

- ▶ Programmable dispensing
- ▶ Automated process
- ▶ Dosing/metering additives
- ▶ Dispensing by weight/weight ratio
- ▶ Repetitive filling
- ▶ Media dispensing in cell culture and fermentation
- ▶ Gradient pump

### BENEFITS

- ▶ Stand-alone digital dispenser or control through PC
- ▶ Graphical LCD shows flow rate, rpm, dispense volume, dispense time, copy number, and cumulative volume
- ▶ Programmable dispense interval for automated dispensing
- ▶ Dispense by volume or time
- ▶ Analog remote control of speed, start/stop, and direction
- ▶ Programmed calibration ensures accuracy
- ▶ Stackable, splash-resistant housing wipes down for easy cleaning

### FEATURES

- ▶ 1/10-hp, continuous-duty brushless drive
- ▶ ±0.1% PWM speed control accuracy with tach output
- ▶ Remote control capability via DB25 connector on back of drive
- ▶ Membrane keypad with lockout



77924-50



77924-60

### SPECIFICATIONS & ORDERING INFORMATION

ISO 9001:2008  
CERTIFIED SUPPLIER



2 year  
warranty

Catalog number	Flow range† (mL/min)	Pump head included	Tubing included	Tubing sizes accepted	Drive included	Drive speed range (rpm)	Drive IP rating	Power (50/60 Hz)
<a href="#">HL-77924-50</a>	0.08 to 480	L/S Easy-Load® 3 77800-60	C-Flex® ULTRA L/S 16 06434-16; 3 m (10 ft)	L/S 13, L/S 14, L/S 16, L/S 25, L/S 17, L/S 18	07551-00	0.1 to 600	IP33	90 to 130 VAC, 2.2 A; and 190 to 260 VAC, 1.1 A
<a href="#">HL-77924-60</a>	0.28 to 1700	L/S Easy-Load II 77200-62	C-Flex ULTRA L/S 24 06434-24; 3 m (10 ft)	L/S 15, L/S 24, L/S 35, L/S 36				

†Flow range with included tubing; extend the flow range of these systems with additional sizes of tubing; order on pages 68–73.

[HL-07523-92](#) **Foot switch**, momentary start/stop; 1.8-m (6-ft) cable.

[HL-07523-95](#) **Cable assembly**, DB25 male connector and 25-ft (7.9-m) cable with stripped wire ends for remote control.

[HL-07523-97](#) **Dispensing handle** for momentary start/stop.

[HL-17050-01](#) **NIST-traceable calibration** for peristaltic pump drive

### COMPLETE SYSTEM INCLUDES:

PUMP HEAD

+

TUBING

+

DRIVE

## MASTERFLEX® LINKABLE INSTRUMENT CONTROL SOFTWARE

### Enhanced balance interface capability and 21 CFR Part 11 compliance

- ▶ Control all functions of up to 25 Masterflex L/S computer-compatible pumps with your personal computer
- ▶ Windows®-based software has familiar pull-down menus and mouse-selectable icons
- ▶ Customize to meet your application: dispensing, mixing/diluting, flow proportioning, and single/multiple slope gradients; program each pump to automate up to 50 steps
- ▶ Improved balance interface allows you to dispense off of a balance and features weight-ratio dispensing; use of multiple balances is enabled with multiple COM ports on your PC
- ▶ Log at specific intervals, at the end of each block, or at the end of each run
- ▶ Complies with 21 CFR Part 11: password protection and authorized user list, audit trail documents all operations, file encryption permits authorized user access only

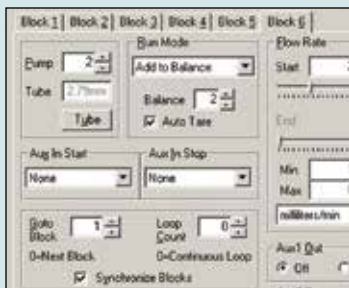

**Design your own program using the simple-to-use software. Quick updates provide up-to-the-minute pump information.**

### ORDERING INFORMATION

Catalog number	Description
<a href="#">HL-07551-70</a>	Software, WINLIN pump control; works with Windows® 95/98/NT/2000/XP; CD-ROM format.
<a href="#">HL-22050-54</a>	RS-232 interface cable, DB9(M) to DB9(F), 2.4 m (8 ft). Connects drive to drive and/or drive to PC.
<a href="#">HL-22050-58</a>	USB to RS-232 serial adapter cable connects RS-232 serial connector on Masterflex L/S 07551-series drives to a PC with USB port, 1.8 m (6 ft); requires cable 22050-54
<a href="#">HL-22050-60</a>	USB Type A (M) to USB Type B (M) interface cable, connect Masterflex 07551-series drives to a USB port on a PC, 3 m (10 ft)
<a href="#">HL-07550-64</a>	RS-232 interface cable, 2.4 m (8 ft). Connects mixer to PC. RJ11 to DB25 with DB25/DB9 adapter.

## L/S® MULTICHANNEL PUMP SYSTEMS

### APPLICATIONS

- Precision dispensing into multiple containers
- Transfer or meter fluids through multiple lines
- Rapid automated filling

### BENEFITS

- Control of multiple channels with a single drive reduces operating cost per channel
- Powerful metering and transfer pump with accurate speed control
- Synchronous flow from all four channels ensures accuracy when dispensing into multiple containers
- Reversible motor for purge before/after pumping; pump in either direction
- Simple keypad controls; bright, three-digit display of rpm for repeatability
- Remote control of speed and start/stop
- Accepts L/S two-stop tube sets for optimal tension with no adjustment
- Stackable ABS plastic housing wipes down for easy cleaning

### FEATURES

- Four-channel pump head
- 1/10-hp, continuous-duty drive with remote capability
- ±0.25% speed control accuracy

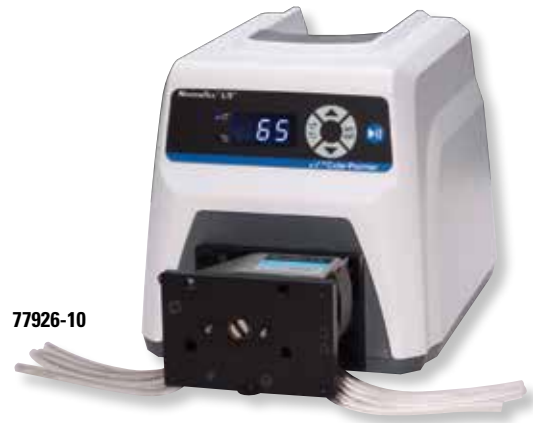

77926-10



77927-10

### SPECIFICATIONS & ORDERING INFORMATION

ISO9001:2008 CERTIFIED SUPPLIER   2 year warranty

Catalog number	Flow range† (mL/min)	Pump head included	Tubing included	Tubing sizes accepted	Drive included	Drive speed range (rpm)	Drive IP rating	Power (50/60 Hz)
<a href="#">HL-77926-10</a>	0.47 to 47	L/S four channel 07535-04	Tygon® E-LFL tube set, L/S 16 06447-16; pk of 8	L/S two-stop tube sets: L/S 13, L/S 14, L/S 16	07528-30	1 to 100	IP33	90 to 260 VAC
<a href="#">HL-77927-10</a>	2.8 to 280	L/S four channel 07536-04	Tygon E-LFL tube set, L/S 24 06447-24; pk of 4	L/S two-stop tube sets: L/S 15, L/S 24, L/S 35	07528-30	1 to 100	IP33	90 to 260 VAC

†Flow range with included tubing; extend the flow range of these systems with additional sizes of tubing; order two-stop tube sets below and L/S extension tubing on pages 68–73.

[HL-77595-35](#) Foot switch, DB9 male. Use for start/stop operation.

[HL-07595-45](#) Connector, DB9 male. Use for 4–20 mA remote control.

[HL-17050-01](#) NIST-traceable calibration for peristaltic pump drive.







### COMPLETE SYSTEM INCLUDES:

PUMP HEAD

+ TUBING

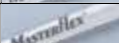
+ DRIVE

### ADDITIONAL L/S TWO-STOP PRECISION PUMP TUBE SETS

Pump tubing		L/S Precision pump tubing			L/S High-performance precision pump tubing		
		L/S 13	L/S 14	L/S 16	L/S 15	L/S 24	L/S 35
Flow rate per channel (mL/min)	@ 1 to 100 rpm @ 6 to 600 rpm	0.045 to 4.5 0.27 to 27	0.16 to 16 0.96 to 96	0.47 to 47 2.8 to 280	1.6 to 160 10 to 1000	2.8 to 280 17 to 1700	3.8 to 380 23 to 2300
Tygon® E-LFL		<a href="#">HL-06447-13</a>	<a href="#">HL-06447-14</a>	<a href="#">HL-06447-16</a>	<a href="#">HL-06447-15</a>	<a href="#">HL-06447-24</a>	<a href="#">HL-06447-35</a>
Silicone (platinum-cured)		<a href="#">HL-06421-13</a>	<a href="#">HL-06421-14</a>	<a href="#">HL-06421-16</a>	<a href="#">HL-06421-15</a>	<a href="#">HL-06421-24</a>	<a href="#">HL-06421-35</a>
BioPharm Plus silicone (platinum-cured)		<a href="#">HL-96116-13</a>	<a href="#">HL-96116-14</a>	<a href="#">HL-96116-16</a>	<a href="#">HL-96116-15</a>	<a href="#">HL-96116-24</a>	<a href="#">HL-96116-35</a>
PharMed® BPT		<a href="#">HL-96114-13</a>	<a href="#">HL-96114-14</a>	<a href="#">HL-96114-16</a>	<a href="#">HL-96114-15</a>	<a href="#">HL-96114-24</a>	<a href="#">HL-96114-35</a>
Chem-Durance® Bio		<a href="#">HL-96117-13</a>	<a href="#">HL-96117-14</a>	<a href="#">HL-96117-16</a>	<a href="#">HL-96117-15</a>	<a href="#">HL-96117-24</a>	<a href="#">HL-96117-35</a>
Viton®		<a href="#">HL-96428-13</a>	<a href="#">HL-96428-14</a>	<a href="#">HL-96428-16</a>	<a href="#">HL-96428-15</a>	<a href="#">HL-96428-24</a>	<a href="#">HL-96428-35</a>
Qty/pk		8	8	8	4	4	4



## L/S® CARTRIDGE PUMP SYSTEMS

### APPLICATIONS

- Multiple-channel low-flow transfer and perfusion
- Synchronous multichannel dispensing
- Low-pressure chromatography
- Feeding automated dispensers

### BENEFITS

- Cartridges accept multiple tubing sizes for wide flow range
- Cartridges snap in and out for tubing changes; change tubing in one channel without disturbing others
- Finely adjust occlusion to increase accuracy
- Use only one cartridge, or load to capacity
- Digital dispensing drive features maintenance-free brushless motor
- Program dispensing parameters, including delay interval, for automated dispensing
- Four-channel, eight-roller pump offers lowest pulsation for better accuracy

### FEATURES

- 1/10-hp continuous-duty brushless drive
- Tach feedback for ±0.1% drive speed control
- Remote control via DB25 female connector on drive
- IP33 rated, stackable ABS housing
- Membrane keypad with lockout



77919-20



77919-30

### SPECIFICATIONS & ORDERING INFORMATION



Catalog number	Flow range† (mL/min)	Pump head included	Tubing included	Tubing sizes accepted	Drive included	Drive speed range (rpm)	Drive IP rating	Power (50/60 Hz)
<b>L/S eight-channel four-roller cartridge pump system</b>								
<a href="#">HL-77919-20</a>	0.0034 to 18	L/S Cartridge head 07519-06 with eight small cartridges 07519-80	Tygon® E-LFL microbore tube set, 1.42-mm ID 06447-34; pk of 12	Microbore tube sets; L/S 13, L/S 14	07523-90	0.02 to 100	IP33	90 to 130 VAC, 2.2 A; 190 to 260 VAC, 1.1 A
<b>L/S reduced-pulsation four-channel eight-roller cartridge pump system</b>								
<a href="#">HL-77919-30</a>	0.0024 to 12	L/S Cartridge head 07519-20 with four small cartridges 07519-85	Tygon E-LFL microbore tube set, 1.42-mm ID 06447-34; pk of 12	Microbore tube sets; L/S 13, L/S 14	07523-90	0.02 to 100	IP33	90 to 130 VAC, 2.2 A; 190 to 260 VAC, 1.1 A

†Flow range with included tubing; extend the flow range of these systems with additional sizes of tubing; order microbore two-stop tube sets below and L/S tubing on pages 68-73.

[HL-17050-01](#) NIST-traceable calibration for peristaltic pump drive.

### ADDITIONAL MICROBORE TWO-STOP PUMP TUBE SETS

Pump tubing		0.89 mm ID	1.42 mm ID	2.06 mm ID	2.79 mm ID
Flow rate per channel (mL/min)	Cartridge head 07519-06	0.0015 to 7.4	0.0034 to 18	0.0074 to 37	0.0126 to 63
	Cartridge head 07519-20	0.0010 to 5.2	0.0024 to 12	0.0044 to 22	0.0068 to 34
Platinum-cured silicone		<a href="#">HL-06421-26</a> pk of 6	<a href="#">HL-06421-34</a> pk of 6	<a href="#">HL-06421-42</a> pk of 6	<a href="#">HL-06421-48</a> pk of 6
	Santoprene®	<a href="#">HL-06431-26</a> pk of 12	<a href="#">HL-06431-34</a> pk of 12	<a href="#">HL-06431-42</a> pk of 12	<a href="#">HL-06431-48</a> pk of 12
Tygon® E-LFL		<a href="#">HL-06447-26</a> pk of 12	<a href="#">HL-06447-34</a> pk of 12	<a href="#">HL-06447-42</a> pk of 12	<a href="#">HL-06447-48</a> pk of 12
Viton®		<a href="#">HL-96428-26</a> pk of 12	<a href="#">HL-96428-34</a> pk of 12	<a href="#">HL-96428-42</a> pk of 12	<a href="#">HL-96428-48</a> pk of 12

### ADDITIONAL CARTRIDGES

[HL-07519-80](#) Additional small cartridge for pump system 77919-20.

[HL-07519-85](#) Additional small cartridge for pump system 77919-30.



07519-80

## LS® DIGITAL MODULAR PUMP SYSTEM

### APPLICATIONS

- ▶ Epoxy resin delivery
- ▶ Culture media dispensing
- ▶ Coffee-additive dispensing
- ▶ FDA tablet coating

### BENEFITS

- ▶ Separate drive/controller for placement flexibility
- ▶ Brushless motor for continuous-duty maintenance-free operation
- ▶ Remote I/O for control flexibility; tach output lets you monitor pump operation
- ▶ Easy tubing changes saves operator time
- ▶ Reverse pumping to prime or purge tubing
- ▶ Programmable time delay interval for repetitive filling

### FEATURES

- ▶ 1/10-hp, continuous-duty drive
- ▶ ±0.1% drive speed accuracy
- ▶ Controller/drive connected by a 1.8-m (6-ft) cable



77923-80

ISO9001:2008 CERTIFIED SUPPLIER ETL US CE 2 year warranty

### SPECIFICATIONS & ORDERING INFORMATION

Catalog number	Flow range† (mL/min)	Pump head included	Tubing included	Tubing sizes accepted	Drive included	Drive speed range (rpm)	Drive IP rating	Power
<a href="#">HL-77923-80</a>	0.28 to 1700	L/S Easy-Load® II 77200-62	C-Flex® ULTRA L/S 24 06434-24; 3 m (10 ft)	L/S 15, L/S 24, L/S 35, L/S 36	77301-40	0.1 to 600	IP33	90 to 130 VAC, 2.2 A; and 190 to 260 VAC, 1.1 A

†Flow range with included tubing; extend the flow range of these systems with additional sizes of tubing; order on pages 68–73.

[HL-07523-97 Handheld remote controller](#); control start/stop, direction, and prime; route tubing through handle for dispensing and filling applications; 1.8-m (6-ft) cable.

[HL-07523-95 Cable assembly](#), DB25 male connector and 7.9-m (25-ft) cable with stripped wire ends for remote control.

[HL-77301-82 Extension cable](#), 2.7 m (9 ft) for benchtop modular drive 77301-40; extend distance between motor and controller.

[HL-17050-01 NIST-traceable calibration](#) with data for peristaltic pump drive.

## LS® DIGITAL MODULAR PUMP SYSTEM WITH WALL-MOUNT CONTROLLER

### APPLICATIONS

- ▶ Adhesive resin delivery
- ▶ Salad dressing dispensing
- ▶ Food-additive dispensing
- ▶ Packaging process pump

### BENEFITS

- ▶ Washdown IP66 (NEMA 4X)-rated components for easy cleanup in process applications
- ▶ Remote I/O for control flexibility; tach output lets you monitor pump operation
- ▶ Brushless motor for continuous-duty maintenance-free operation
- ▶ Easy tubing changes
- ▶ Repetitive dispensing with programmable delay for efficient repeat filling operations

### FEATURES

- ▶ 1/10-hp, continuous-duty drive
- ▶ ±0.1% drive speed accuracy
- ▶ IP66-rated controller/drive connected by a 1.8-m (6-ft) water-tight cable



77923-90

ISO9001:2008 CERTIFIED SUPPLIER ETL US CE 2 year warranty

### SPECIFICATIONS & ORDERING INFORMATION

Catalog number	Flow range† (mL/min)	Pump head included	Tubing included	Tubing sizes accepted	Drive included	Drive speed range (rpm)	Drive IP rating	Power
<a href="#">HL-77923-90</a>	0.28 to 1700	L/S Easy-Load® II 77200-62	C-Flex® ULTRA L/S 24 06434-24; 3 m (10 ft)	L/S 15, L/S 24, L/S 35, L/S 36	77301-50	0.1 to 600	IP66	90 to 130 VAC, 2.2 A; and 190 to 260 VAC, 1.1 A

†Flow range with included tubing; extend the flow range of these systems with additional sizes of tubing; order on pages 68–73.

[HL-07575-84 Washdown foot switch](#), momentary start/stop; 1.8-m (6-ft) cable.

[HL-07575-80 Remote control cable](#); wire to controller/PLC; 8.3-m (25-ft) length.

[HL-77301-82 Extension cable](#), 2.7 m (9 ft) for washdown modular drive 77301-50; extend distance between motor and controller.

[HL-17050-01 NIST-traceable calibration](#) with data for peristaltic pump drive.



## L/S<sup>®</sup> DIGITAL PROCESS PUMP SYSTEMS

### APPLICATIONS

- Pharma, food, and dairy processing
- Metering flavorings and colorants
- Pumping buffer solutions
- Filling/emptying media bags
- Sterile filtration; sterile fluid transfer
- Spray coating
- Pumping slurries and purees

### BENEFITS

- Digital dispenser is ideal for filling applications requiring varying flow rates and volumes
- Sealed, 316 stainless steel housing is NEMA 4X and IP66 rated for easy washdown in sanitary process environments; use model 77975-40 with powder-coat steel housing in applications where stainless steel is not a requirement
- Graphical LCD shows flow rate, rpm, dispense volume, dispense time, and copy number
- Cumulative volume function totalizes volume pumped or transferred over time
- Select to display metric or English units
- Programmable dispense interval for automated dispensing
- Analog remote control of speed, start/stop, and direction; tach output for monitoring pump operation
- Programmed calibration ensures accuracy
- Keypad lockout feature prevents inadvertent changes to programmed settings

### FEATURES

- 1/10-hp, continuous-duty brushless drive
- ±0.1% PWM speed control accuracy with tach output
- Remote control capability via fluid-resistant I/O connector on back of drive



77975-30



07575-84



77975-20



77975-40

### SPECIFICATIONS & ORDERING INFORMATION

ISO9001:2008  
CERTIFIED SUPPLIER



2 year  
warranty

Catalog number	Flow range† (mL/min)	Pump head included	Tubing included	Tubing sizes accepted	Drive included	Drive speed range (rpm)	Drive IP rating	Power
<b>Digital process pumps with 316 stainless steel housing</b>								
<a href="#">HL-77975-20</a>	0.28 to 1700	L/S Easy-Load <sup>®</sup> II 77200-62	C-Flex <sup>®</sup> ULTRA L/S 24 06434-24; 3 m (10 ft)	L/S 15, L/S 24, L/S 35, L/S 36	07575-10	0.1 to 600	IP66	90 to 130 VAC, 2.2 A; and 190 to 260 VAC, 1.1 A
<a href="#">HL-77975-30</a>	0.28 to 1800	L/S High-Performance 77250-62	C-Flex ULTRA L/S 24 06434-24; 3 m (10 ft)	L/S 15, L/S 24, L/S 35, L/S 36	07575-10	0.1 to 600	IP66	90 to 130 VAC, 2.2 A; and 190 to 260 VAC, 1.1 A
<b>Digital process pump with powder-coat steel housing</b>								
<a href="#">HL-77975-40</a>	0.28 to 1700	L/S Easy-Load II 77200-62	C-Flex ULTRA L/S 24 06434-24; 3 m (10 ft)	L/S 15, L/S 24, L/S 35, L/S 36	07575-20	0.1 to 600	IP66	90 to 130 VAC, 2.2 A; and 190 to 260 VAC, 1.1 A

†Flow range with included tubing; extend the flow range of these systems with additional sizes of tubing; order on pages 68–73.

[HL-07575-84](#) Washdown foot switch, momentary start/stop; 1.8-m (6-ft) cable

[HL-07575-80](#) Remote cable, 8.3 m (25 ft) for remote capabilities.

[HL-17050-01](#) NIST-traceable calibration for peristaltic pump drive.



### FILLER/DISPENSING NOZZLES

- Maximize the speed, precision, and accuracy of dispensing and filling applications
- Minimize splashing and dripping when dispensing into narrow- or wide-mouth containers

These nozzles combine the ease of plastic components with the accuracy and reliability of stainless steel tubes. Tight dimensional tolerances help to ensure precision in your dispensing applications. Nozzles feature a 316L stainless steel tube and a polycarbonate base with hose barb adapter. Materials comply with FDA, USDA and USP Class VI requirements. All filler nozzles are sterilizable by ethylene oxide, autoclaving, or gamma irradiation.

Catalog number	Tubing ID
<a href="#">HL-30619-06</a>	1/32"
<a href="#">HL-30619-01</a>	1/16"
<a href="#">HL-30619-07</a>	1/8"
<a href="#">HL-30619-02</a>	3/16"
<a href="#">HL-30619-08</a>	1/4"
<a href="#">HL-30619-03</a>	5/16"
<a href="#">HL-30619-09</a>	3/8"
<a href="#">HL-30619-04</a>	1/2"
<a href="#">HL-30619-10</a>	5/8"
<a href="#">HL-30619-05</a>	3/4"



30619-02



## LS® PTFE-TUBING PUMP SYSTEM

### APPLICATIONS

- ▶ Transfer of aggressive chemicals
- ▶ Filtration
- ▶ High-purity pumping
- ▶ Chemical injection

### BENEFITS

- ▶ Excellent chemical compatibility for metering aggressive chemicals
- ▶ Higher pressures up to 6.9 bar (100 psi), low pulsation
- ▶ Inert PTFE tubing maintains fluid purity
- ▶ Adjustable occlusion
- ▶ Low maintenance

### FEATURES

- ▶ 1/10-hp, 3 to 300 rpm continuous-duty drive
- ▶ 2.4-m (8-ft) suction lift; 6.9 bar (100 psi) pressure capability



77912-10

### ADDITIONAL TUBING

**HL-77390-60 PTFE tubing set**, 6-mm OD, 4-mm ID. Set of two 38-cm (15") lengths

**HL-06605-54 PTFE extension tubing**, 6-mm OD. One 7.6-m (25-ft) length

**HL-31321-64 Straight connector**, 6 mm, 9.2 bar (135 psi) max

### SPECIFICATIONS & ORDERING INFORMATION

ISO9001:2008  
CERTIFIED SUPPLIER



2 year  
warranty

Catalog number	Flow range (mL/min)	Pump head included	Tubing included†	Tubing sizes accepted	Drive included	Drive speed range (rpm)	Drive IP rating	Power (50/60 Hz)
<a href="#">HL-77912-10</a>	0.75 to 65	L/S PTFE-tubing 77390-00	6-mm OD PTFE tubing set 77390-60	—	07528-20	3 to 300‡	IP33	90 to 260 VAC

†Also includes two 1/4" pipe adapters. ‡Recommended drive speed operating range for included pump head.

[HL-17050-01 NIST-traceable calibration](#) for peristaltic pump drive.

### COMPLETE SYSTEM INCLUDES:

PUMP HEAD

+ TUBING

+ DRIVE

## LS® PTFE-DIAPHRAGM PUMP SYSTEM

### APPLICATIONS

- ▶ Chemical feed and metering
- ▶ Chemical injection
- ▶ High-purity fluid transfer
- ▶ Pumping aggressive chemicals
- ▶ High-pressure pumping

### BENEFITS

- ▶ Continuous pressure up to 3.4 bar (50 psi); 5.2 bar (75 psi) intermittent
- ▶ Excellent chemical compatibility
- ▶ High metering accuracy
- ▶ Self-priming
- ▶ PTFE fluid path maintains fluid purity

### FEATURES

- ▶ 1/10-hp, 6 to 600 rpm continuous-duty drive
- ▶ ±0.25% speed control accuracy
- ▶ ABS plastic housing
- ▶ DB9 female connection on back for remote control



77915-10

### SPECIFICATIONS & ORDERING INFORMATION

ISO9001:2008  
CERTIFIED SUPPLIER



2 year  
warranty

Catalog number	Flow range (mL/min)	Pump head included	Tubing included†	Tubing sizes accepted	Drive included	Drive speed range (rpm)	Drive IP rating	Power (50/60 Hz)
<a href="#">HL-77915-10</a>	80 to 800	L/S PTFE diaphragm 07090-42	1/4" ID x 3/8" OD PTFE tubing 06605-15; 3.6 m (12 ft)	—	07528-10	40 to 400‡	IP33	90 to 260 VAC

†Also includes pipe adapters and check valve. ‡Recommended drive speed operating range for included pump head.

[HL-07090-43 Service kit](#) includes diaphragm, check valves, installation tool and instructions.

[HL-07090-45 Check valve](#).



## L/S<sup>®</sup> HIGH-PRESSURE PUMP SYSTEM

### APPLICATIONS

- High-pressure chemical feed and metering
- High-pressure chemical injection
- Chromatography
- Pressure filtration
- Sterile filtration

### BENEFITS

- Pump at continuous pressure up to 6.9 bar (100 psi) with included tubing
- No gears, valves, seals, or diaphragms for minimal maintenance and downtime
- Fluid remains in tubing at all times; contamination-free
- Separate speed control and power switch maintain speed setting when pump is switched on/off
- Reversible motor; pump in either direction

### FEATURES

- 1/10-hp, continuous-duty drive
- ±0.25% speed control accuracy
- ABS plastic housing

### ADDITIONAL TUBING

**HL-95664-14 L/S PharMed BPT 14HP high-pressure tubing:** 0.3 to 30 mL/min, 10.2 bar (150 psi) max pressure. Pack of 7.6 m (25 ft).

**HL-95664-16 L/S PharMed BPT 16HP high-pressure tubing:** 0.9 to 90 mL/min, 6.9 bar (100 psi) max pressure. Pack of 7.6 m (25 ft).

**HL-95664-15 L/S PharMed BPT 15HP high-pressure tubing:** 1.7 to 170 mL/min, 5.4 bar (80 psi) max pressure. Pack of 7.6 m (25 ft).

**HL-95664-24 L/S PharMed BPT 24HP high-pressure tubing:** 2.4 to 240 mL/min, 4.1 bar (60 psi) max pressure. Pack of 7.6 m (25 ft).



77914-10

ISO9001:2008  
CERTIFIED SUPPLIER



2 year  
warranty

### SPECIFICATIONS & ORDERING INFORMATION

Catalog number	Flow range <sup>†</sup> (mL/min)	Pump head included	Tubing included	Tubing sizes accepted	Drive included	Drive speed range (rpm)	Drive IP rating	Power (50/60 Hz)
<a href="#">HL-77914-10</a>	0.9 to 90	L/S High-Performance 77250-62	PharMed <sup>®</sup> BPT L/S 16HP 95664-16; 2.4 m (8 ft)	L/S 16HP, L/S 15HP, L/S 24HP	07528-30	1 to 100	IP33	90 to 260 VAC

<sup>†</sup>Flow range with included tubing; extend the flow range of these systems with additional sizes of tubing; order above.

## L/S<sup>®</sup> AIR-POWERED PUMP SYSTEMS

### APPLICATIONS

- Transfer of chemicals where hazardous vapors are present
- Transfer of printing inks and solvents
- Transfer of heat-sensitive fluids
- Production fermentation

### BENEFITS

- Ideal where electricity is unsafe
- Operates from your compressor
- High power, compact size
- Cooler operation
- Smooth-starting, low-maintenance 1/3-hp motor

### FEATURES

- 1/3-hp, continuous-duty drive
- ±10% drive speed accuracy
- Complete with regulator with 5-mm air filter and 1/4" NPT(F) connection, automatic lubricator, 0 to 20 psi pressure gauge, and muffler
- ATEX systems 77931-20 and -30 are ATEX Zone 2 rated: EEx II 3 G c IIC T6; NEC Class I, Division 2, Groups A, B, C, D, T6



77931-10



77931-20

### SPECIFICATIONS & ORDERING INFORMATION

Catalog number	Flow range (mL/min)	Pump head included	Tubing included	Tubing sizes accepted	Drive included	Drive speed range (rpm)	Drive IP rating	Power
<a href="#">HL-77931-10</a>	170 to 1700 <sup>†</sup>	L/S Easy-Load <sup>®</sup> II 77200-62	C-Flex <sup>®</sup> ULTRA L/S 24 06434-24; 3 m (10 ft)	L/S 15, L/S 24, L/S 35, L/S 36	07569-00	60 to 600	IP44	0.08 to 0.7 m <sup>3</sup> /min (3 to 25 cfm) at 1.4 to 6.9 bar (20 to 100 psi)

#### ATEX Zone 2 rated L/S air-powered pump systems

<a href="#">HL-77931-20</a>	3.6 to 2300 <sup>†</sup>	L/S Easy-Load 07518-40	N/A <sup>††</sup>	L/S 13, L/S 14, L/S 16, L/S 25, L/S 17, L/S 18	07569-00	60 to 600	IP44	0.08 to 0.7 m <sup>3</sup> /min (3 to 25 cfm) at 1.4 to 6.9 bar (20 to 100 psi)
<a href="#">HL-77931-30</a>	100 to 1700 <sup>†</sup>	L/S Easy-Load 07518-42	N/A <sup>††</sup>	L/S 15, L/S 24	07569-00	60 to 600	IP44	0.08 to 0.7 m <sup>3</sup> /min (3 to 25 cfm) at 1.4 to 6.9 bar (20 to 100 psi)

<sup>†</sup>Flow range with included tubing; extend the flow range of these systems with additional sizes of tubing; order on pages 68-73.

<sup>‡</sup>For ATEX pump systems, flow rates will depend on tubing size selected.

<sup>††</sup>Note: ATEX pump systems do not include tubing; select tubing to be compatible with your fluid and the parameters of your application.

**Note:** For safe operation of Masterflex air-powered pumps, ground pump carefully to protect from static electricity.

ISO9001:2008  
CERTIFIED SUPPLIER



ATEX  
Zone 2  
77931-20, -30

2 year  
warranty

## SELECTION GUIDE FOR I/P® PUMP HEADS

### FEATURES OF MASTERFLEX® I/P PUMP HEADS

#### Highly Accurate, Repeatable Performance



- ▶ All Masterflex I/P pump heads are designed to work best with I/P Precision or I/P High-performance precision pump tubing, ensuring lot-to-lot traceability and confidence in pump performance
- ▶ All pump designs accept continuous lengths of tubing, allowing you to:
  - ◆ Customize tubing lengths to your specific application
  - ◆ Simplify sanitary setups—no breaks in tubing
  - ◆ Reduce set up/cleanup time
  - ◆ Eliminate difficult fittings and clamps
  - ◆ Eliminate concerns over the chemical compatibility of fittings
  - ◆ Eliminate need for costly tubing sets
  - ◆ Increase tubing life—simply stop the pump periodically and move tubing 15 to 20 cm (6 to 8 in.), reload, and continue pumping

#### Multiple Roller Design

- ▶ Ensures even flow with minimal pulsation
- ▶ Ball-bearing rollers for long service life
- ▶ Select from cold-rolled steel (CRS) or stainless steel (SS) rotor assemblies
- ▶ Precision and High-performance precision roller configurations

#### Rugged Plastic Housings

- ▶ Molded from engineered plastics to tight specifications
- ▶ Easy to handle
- ▶ Clear polycarbonate (PC) allows viewing of pump head operation
- ▶ Polysulfone (PSF) and polyphenylene sulfide (PPS) offer additional corrosion resistance

Description	Flow rates LPM (GPM)	Number of rollers	Multichannel or stackable	Housing/roller materials†	Special features	Page number
<b>STANDARD</b>						
	Lowest: 0.01 (0.002) Highest: 13 (3.5)	3	Yes, stack up to 2 heads	PC/CRS, PC/SS, or PPS/SS	Low cost, high precision and accuracy. Best choice for dispensing applications. One head accepts one specific tubing size.	120–121
<b>EASY-LOAD®</b>						
	Lowest: 0.01 (0.002) Highest: 13 (3.5)	3	Yes, stack up to 2 heads	PSF/CRS, PSF/SS, or PPS/SS	Quick tubing changes. One head accepts several tubing sizes. Change tubing without dismounting pump head from drive. Model available for ATEX Zone 2 applications.	122–123
<b>HIGH-PERFORMANCE</b>						
	Lowest: 0.01 (0.002) Highest: 19 (5.0)	3	No	SS housing, rotors and rollers. Polyester occlusion bed.	Accepts High-performance precision tubing sizes. Offers highest flow rate of any I/P pump head. Tubing enters and exits same side of pump head. Model available for ATEX Zone 2 applications.	124–125

†PC = polycarbonate PPS = polyphenylene sulfide PSF = polysulfone CRS = cold-rolled steel SS = stainless steel

#### Three Occlusion Options

- 1. Standard Fixed Occlusion:**  
Tubing “squeeze” is fixed, but at slightly different levels for each tubing size to maximize performance in each pump head with respect to tubing life, vacuum and flow characteristics, and repeatability (i.e. Standard pump heads).
- 2. Average Fixed Occlusion:**  
Tubing “squeeze” is fixed at an average level for accepted tubing sizes. This allows pump heads to combine easy tube loading while accepting a wide range of tubing sizes. (i.e. Easy-Load, High-Performance pump heads).
- 3. Adjustable Occlusion:**  
Tubing “squeeze” is adjustable for optimal pump performance to fit a specific application (i.e. Easy-Load pump heads).



#### Adjustable Occlusion

Reducing the occlusion increases tubing life (up to 5X); reduces discharge pressure; decreases pulsation; reduces cell disruption; and increases flow slightly.

Increasing the occlusion decreases tubing life; increases discharge pressure; increases pulsation; increases cell disruption; and decreases flow slightly.

Prolong tubing life by priming the pump with nominal or high occlusion, and reduce occlusion to run.

### PUMP TUBING OPTIONS FOR I/P PUMP HEADS

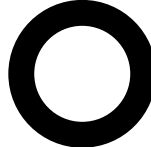
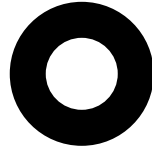
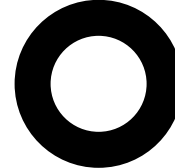
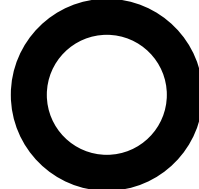
Tubing cross sections	I/P Precision pump tubing sizes			I/P High-performance Precision pump tubing sizes		
						
	I/P 26	I/P 73	I/P 82	I/P 70	I/P 88	I/P 89
Standard		✓	✓			
Easy-Load®	✓	✓	✓			
High-Performance				✓	✓	✓





### A PUMP HEAD FOR EVERY APPLICATION

There are three styles of Masterflex® I/P® pump heads offered to meet your needs for quick fluid transfer—in manufacturing or in the lab. This selection guide is designed to help you choose the pump head that's right for your application.

#### STANDARD PUMP HEAD (pages 120–121)

- ▶ Best overall I/P pump head accuracy
- ▶ Performance is highly repeatable
- ▶ Each pump head designed for one tubing size
- ▶ Fixed occlusion set optimally for tubing size
- ▶ Stack up to 2 heads on Masterflex I/P drives
- ▶ Choice of housing and rotor materials
- ▶ Tubing sizes accepted: Masterflex I/P 73 and I/P 82
- ▶ Tubing loading key (included) ensures proper tubing alignment and tension



Tubing loading key



#### TO SELECT A PUMP HEAD, DETERMINE:

1. Flow rate (LPM).
2. Maximum number of pump heads or flow channels required.
3. Style of pump head desired.
4. Fixed or adjustable occlusion feature.
5. Are corrosive fluids or vapors involved? If so, choose corrosion-resistant PSF or PPS housing and SS rotor.

#### EASY-LOAD® PUMP HEAD (pages 122–123)

- ▶ Load tubing easily without removing pump head from the drive
- ▶ Automatic tubing retention
- ▶ Adjustable occlusion optimizes pressure capabilities and tubing life by adjusting the squeeze on the tubing
- ▶ Tubing guide ensures correct positioning of tubing
- ▶ Stack up to 2 heads on Masterflex I/P drives
- ▶ Choice of housing and rotor materials
- ▶ Tubing sizes accepted: Masterflex I/P 26, I/P 73, and I/P 82
- ▶ ATEX-approved model is rated for Zone 2 applications; EEx II 3 G c II C T6



#### Watch the VIDEO!

See how to load Masterflex pump heads at...  
[Masterflex.com/video](http://Masterflex.com/video)



#### HIGH-PERFORMANCE PUMP HEAD (pages 124–125)

- ▶ Load tubing easily and in a "C" pattern
- ▶ Tubing enters/exits same side of pump head
- ▶ Fixed occlusion averaged for several tubing sizes
- ▶ Adjustable tubing retention prevents tubing from moving in head
- ▶ Not stackable
- ▶ Designed for High-performance precision tubing sizes: I/P 70, I/P 88, and I/P 89
- ▶ ATEX-approved model is rated for Zone 2 applications; EEx II 3 G c II C T6



#### DRIVE COMPATIBILITY

Mount these pump heads on all drives accepting Masterflex I/P pump heads. Look for these pump head icons on specific I/P drive pages to ensure compatibility.

STANDARD  
0.01 to 13 LPM  
pages 120–121



EASY-LOAD®  
0.01 to 13 LPM  
pages 122–123



HIGH-PERFORMANCE  
0.01 to 19 LPM  
pages 124–125



## I/P® STANDARD PUMP HEADS

### FEATURES/BENEFITS

- ▶ Deliver flow rates up to 13 LPM
- ▶ Precision-molded housing
- ▶ Each pump head is designed for one size of tubing, ensuring optimal occlusion and repeatable performance
- ▶ Ideal for dedicated pump applications
- ▶ Adapts easily to OEM use
- ▶ Interchangeable
- ▶ Dual-channel pumping capability—stack heads with optional dual-channel mounting hardware. Order hardware on page 121.

### SELECTION CRITERIA

1. Flow rate/tube size desired.
2. Materials of construction.
3. Compatibility with drives.

Includes 50.8 cm (20") of silicone tubing, loading key, and mounting hardware.

See specifications for more information.

**Order tubing and drives separately.**

### COMPATIBILITY WITH DRIVES

- ▶ Mount on all drives accepting Masterflex® I/P pump heads

### PUMP HOUSING SPECIFICATIONS

#### Clear Polycarbonate (PC)

- ▶ General-purpose applications
- ▶ View operation through the housing
- ▶ Select from CRS/Buna N or 304 SS/PTFE shielded ball-bearing

#### Polyphenylene Sulfide (PPS)

- ▶ Best protection from corrosive liquids/vapors
- ▶ 300-series SS/PTFE shielded ball-bearing



I/P Standard pump head 07019-20 with PC housing and CRS rotor

Tang boot ensures quiet operation and reduces tang wear.



I/P Standard pump head is available with either PC (left) or PPS (right) housing.

ISO 9001:2008  
CERTIFIED SUPPLIER **2** year warranty

### ORDERING INFORMATION

Pump tubing size	PC housing		PPS housing
	CRS rotor	SS rotor	SS rotor

#### For Precision pump tubing

I/P 73	<a href="#">HL-07019-20</a>	<a href="#">HL-07019-21</a>	<a href="#">HL-07019-43</a>
I/P 82	<a href="#">HL-07019-32</a>	<a href="#">HL-07019-31</a>	<a href="#">HL-07019-53</a>

PC = polycarbonate      PPS = polyphenylene sulfide  
CRS = cold-rolled steel      SS = stainless steel

### ROLLER/ROTOR SPECIFICATIONS

#### Plated Cold-Rolled Steel (CRS)

- ▶ General-purpose applications
- ▶ Buna N shielded ball-bearing

#### 300-Series Stainless Steel (SS)



- ▶ Corrosive fluid applications
- ▶ Shielded ball-bearing construction (highest life expectancy)

### ACCESSORIES

[HL-77600-03](#) Replacement tang boots. Pack of 10.

### I/P PUMP TUBING FLOW RATE INFORMATION

Order Masterflex I/P Precision pump tubing separately on pages 126–127.

Tubing cross sections	I/P Precision pump tubing	
	 I/P 73	 I/P 82
Flow rate—mL/rev	12.3	20.0
Flow rate @ 650 rpm	8 LPM (2.1 GPM)	13 LPM (3.5 GPM)
Max pressure†	2.7 bar (40 psi)	1.4 bar (20 psi)
Max vacuum†	610 mm Hg (24" Hg)	510 mm Hg (20" Hg)
Suction lift	7.6 m H <sub>2</sub> O (25 ft H <sub>2</sub> O)	7.0 m H <sub>2</sub> O (23 ft H <sub>2</sub> O)

†Actual performance varies depending upon tubing materials—see pages 20–24 and 172–192 for more information.

### NOTES

Use only Masterflex pump tubing with Masterflex pumps to ensure optimal performance. Use of other tubing may void applicable warranties.



## SPECIFICATIONS for I/P Standard Pump Heads

Catalog number	HL-07019					
	-20	-21	-43	-31	-32	-53
<b>Performance Specifications</b>						
Flow capacity	0.01 to 13 LPM (0.002 to 3.5 GPM)					
Max rpm	650					
Number of rollers	3					
Max pressure	2.7 bar (40 psi)			1.4 bar (20 psi)		
Max vacuum	610 mm Hg (24" Hg)			510 mm Hg (20" Hg)		
<b>Torque Specifications [a single pump head pumping water at 0 bar (0 psi), 21°C (70°F)]</b>						
Norprene®, PharMed® BPT	Starting torque	230 N-cm (325 oz-in)				
	Running torque	92 N-cm (130 oz-in)				
Tygon®, Viton®	Starting torque	353 N-cm (500 oz-in)				
	Running torque	147 N-cm (208 oz-in)				
C-FLEX®, Silicone	Starting torque	205 N-cm (290 oz-in)				
	Running torque	84 N-cm (120 oz-in)				
<b>Physical Specifications</b>						
Housing material	PC	PPS	PC	PPS		
Rotor material	CRS	SS	CRS	SS		
Operating temperature	0 to 40°C (32 to 104°F)					
Shipping weight	1.8 kg (4 lb)					

## MULTICHANNEL CAPABILITIES

Stack up to two Standard pump heads on a single drive when using C-FLEX® or silicone tubing, depending on drive specifications. Order hardware depending on number of pump heads to be mounted.



Two Standard pump heads mounted on drive 07591-20

## MOUNTING HARDWARE

Heads to be mounted	Catalog number/set
	Stainless steel
One	<a href="#">HL-07019-95</a>
Two	<a href="#">HL-07019-96</a>



Mounting hardware 07019-95 for one pump head and 07019-96 for two pump heads.

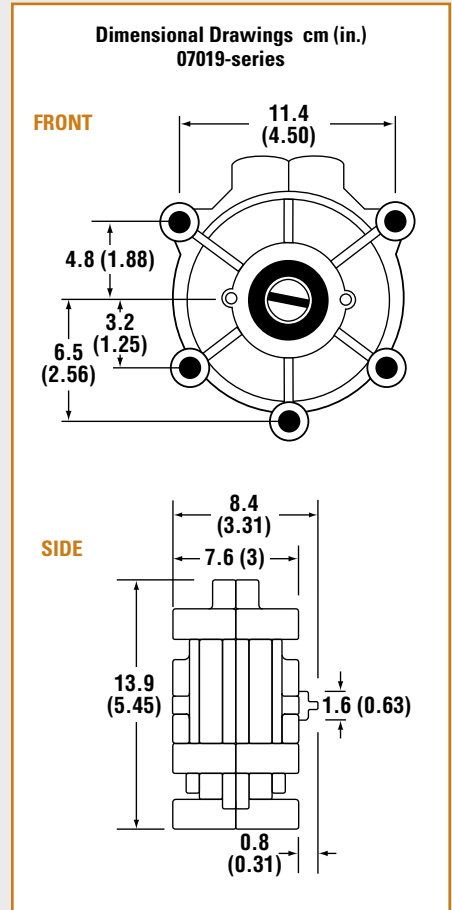

## FOR THE LATEST...

Masterflex technical resources, see

- ColeParmer.com
- Masterflex.com

## HOW TO LOAD YOUR PUMP HEAD



I/P TUBING ..... 126–130  
I/P DRIVES ..... 131–145  
I/P PUMP SYSTEMS ..... 146–151

ACCESSORIES ..... 160–171

TECHNICAL DATA ..... 172–206

## I/P® EASY-LOAD® PUMP HEADS

### FEATURES/BENEFITS

- ▶ Deliver flow rates from 0.01 to 13 LPM
- ▶ Automatic tubing retention ensures correct loading; heads accept several tubing sizes
- ▶ Five-screw mounting for securely attaching to drive
- ▶ Tang boot provides quieter operation and less maintenance
- ▶ Adjustable occlusion optimizes pressure capabilities and tubing life
- ▶ Over-center cam ensures fast tubing changes
- ▶ Precision-molded housing and occlusion bed
- ▶ Ideal for sanitary, corrosive, or general fluid transfer applications
- ▶ Adapt easily to OEM applications
- ▶ Multichannel pumping
- ▶ Model 77601-80 is ATEX Zone 2 rated EEx II 3 G c IIC T6; NEC rated for Class I Division 2, Groups A, B, C, D T6

### SELECTION CRITERIA

1. Flow rate/tubing size desired.
2. Materials of construction.
3. Drive compatibility.

Includes 50.8 cm (20") of silicone tubing and single-channel mounting hardware.

See specifications for more information.

Order tubing and drives separately.

### COMPATIBILITY WITH DRIVES

- ▶ Mount on drives that accept Masterflex® I/P pump heads

### PUMP HOUSING SPECIFICATIONS

#### Polysulfone (PSF)

- ▶ General-purpose applications
- ▶ Select from CRS/Buna N or 304 SS/PTFE shielded ball-bearing

#### Polyphenylene Sulfide (PPS)

- ▶ Best protection from corrosive liquids/vapors
- ▶ 300-series SS/PTFE shielded ball-bearing



Polysulfone (PSF) pump head 77601-00

Polyphenylene sulfide (PPS) pump head 77601-60

### ROLLER/ROTOR SPECIFICATIONS

#### Plated Cold-Rolled Steel (CRS)

- ▶ General-purpose applications
- ▶ Recommended for fluids at temperatures below 80°C (175°F)
- ▶ Buna N shielded ball-bearing construction

#### 300-Series Stainless Steel (SS)

- ▶ Corrosive fluids
- ▶ Recommended for fluids at temperatures above 80°C (175°F)
- ▶ PTFE shielded ball-bearing construction (highest life expectancy)

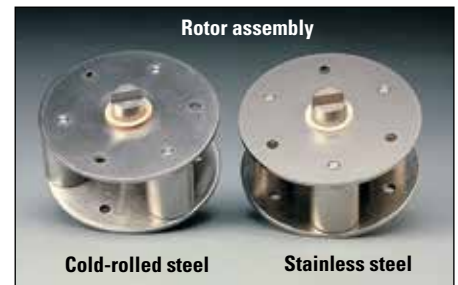

Cold-rolled steel

Stainless steel



I/P Easy-Load pump head 77601-10 mounted on variable-speed modular drive 07591-20



2 year warranty

### ORDERING INFORMATION

Pump tubing size	PSF housing		PPS housing	ATEX-approved PSF housing
	CRS rotor	SS rotor	SS rotor	SS rotor



#### For Precision tubing

I/P 26				
I/P 73	<a href="#">HL-77601-00</a>	<a href="#">HL-77601-10</a>	<a href="#">HL-77601-60</a>	<a href="#">HL-77601-80</a>
I/P 82				

PSF = polysulfone PPS = polyphenylene sulfide  
CRS = cold-rolled steel SS = stainless steel

### I/P PUMP TUBING FLOW RATE INFORMATION

Order Masterflex I/P Precision pump tubing separately on pages 126–127.

Tubing cross sections	I/P Precision pump tubing		
			
	I/P 26	I/P 73	I/P 82
Flow rate—mL/rev	6.2	12.3	20.0
Flow rate @ 650 rpm	4 LPM (1.1 GPM)	8 LPM (2.1 GPM)	13 LPM (3.5 GPM)
Max pressure <sup>†</sup>	2.7 bar (40 psi)		1.4 bar (20 psi)
Max vacuum <sup>†</sup>	610 mm Hg (24" Hg)		510 mm Hg (20" Hg)
Suction lift	7.6 m H <sub>2</sub> O (25 ft H <sub>2</sub> O)		7.0 m H <sub>2</sub> O (23 ft H <sub>2</sub> O)

<sup>†</sup>Actual performance varies depending upon tubing materials—see pages 20–24 and 172–192 for more information.

### NOTES

Use only Masterflex pump tubing with Masterflex pumps to ensure optimal performance. Use of other tubing may void applicable warranties.



## SPECIFICATIONS for I/P Easy-Load Pump Heads

Catalog number	<a href="#">HL-77601-00</a>	<a href="#">HL-77601-10</a> <a href="#">HL-77601-80</a>	<a href="#">HL-77601-60</a>
<b>Performance Specifications</b>			
Flow capacity	0.01 to 13 LPM (0.002 to 3.5 GPM)		
Max rpm	650		
Number of rollers	3		
Max pressure for I/P 26 & 73	2.7 bar (40 psi)		
Max pressure for I/P 82	1.4 bar (20 psi)		
Max vacuum	610 mm Hg (24" Hg) <sup>‡</sup>		
Max suction lift	7.6 m H <sub>2</sub> O (25 ft H <sub>2</sub> O) <sup>‡</sup>		
<b>Torque Specifications [a single pump head pumping water at 0 bar (0 psi), 21°C (70°F)]</b>			
Norprene®, PharMed® BPT	Starting torque	316 N-cm (448 oz-in)	
	Running torque	64 N-cm (90 oz-in)	
Tygon®, Viton®	Starting torque	316 N-cm (448 oz-in)	
	Running torque	64 N-cm (90 oz-in)	
C-FLEX®, Silicone	Starting torque	180 N-cm (256 oz-in)	
	Running torque	46 N-cm (65 oz-in)	
<b>Physical Specifications</b>			
Housing material	Polysulfone		Polyphenylene sulfide
Rotor material	Cold-rolled steel	Stainless steel	
Operating temperature	0 to 40°C (32 to 104°F)		
Shipping weight	2.3 kg (5 lb)		

<sup>‡</sup>Depending on tubing size.

## MULTICHANNEL CAPABILITIES

Mount up to two Easy-Load pump heads on a single drive. Change tubing without removing heads. Order hardware based on the number of pump heads to be mounted.



Two Easy-Load pump heads mounted on drive 77411-00.

## MOUNTING HARDWARE

Heads to be mounted	Catalog number/set Stainless steel
One	<a href="#">HL-77601-95</a>
Two	<a href="#">HL-77601-96</a>



Mounting hardware 77601-95 for one pump head and 77601-96 for two pump heads.

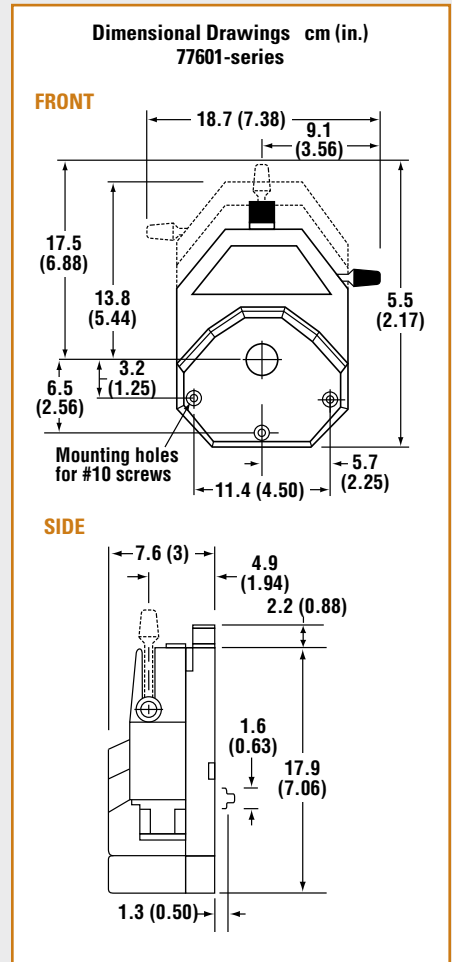

## FOR THE LATEST...

Masterflex technical resources, see

- ColeParmer.com
- Masterflex.com

## HOW TO LOAD YOUR PUMP HEAD



1. Move lever to the left to open pump head. Load the correct size tubing.



2. Rotate the lever to the right to close head. Adjust occlusion setting by turning knob on top of pump head.



3. Tubing is retained by automatic tubing retention.

I/P* TUBING .....	126-130
I/P* DRIVES .....	131-145
I/P* PUMP SYSTEMS .....	146-151

ACCESSORIES..... 160-171

TECHNICAL DATA..... 172-206

## I/P® HIGH-PERFORMANCE PUMP HEADS

### FEATURES/BENEFITS

- ▶ For higher volume fluid transfer applications
- ▶ Deliver flow rates from 0.01 to 19 LPM
- ▶ Highest flow rates of any I/P pump head
- ▶ Ideal for viscous fluid transfer
- ▶ C-shaped—allows tubing to enter and exit the same side of pump head
- ▶ Easy to load: accepts Masterflex® I/P High-Performance Precision tubing
- ▶ Tubing enables better pressure generation and suction lift
- ▶ Adjustable tubing retention prevents tubing movement in head
- ▶ Compatible with all Masterflex I/P drives that accept two or more pump heads
- ▶ Model 77600-82 is ATEX Zone 2 rated EEx II 3 G c IIC T6; NEC rated for Class I Division 2, Groups A, B, C, D T6



I/P high-performance pump head 77600-62

### SELECTION CRITERIA

1. Flow rate desired.
2. Tubing size desired.
3. Compatibility with drives.

Includes 50.8 cm (20") of silicone tubing and single-channel mounting hardware.

See specifications for more information.

**Order tubing and drives separately.**

### COMPATIBILITY WITH DRIVES

- ▶ Mount pumps on all Masterflex I/P drives

### PUMP HOUSING SPECIFICATIONS

- ▶ Stainless steel rotor plates/shaft, rollers, and bearings
- ▶ Thermoset polyester occlusion bed

### MULTICHANNEL CAPABILITIES

- ▶ I/P High-performance pump heads are not designed to be stacked

### ROLLER/ROTOR SPECIFICATIONS

- ▶ Stainless steel with PTFE shielded ball bearing
- ▶ Operating temperature: 0 to 40°C (32 to 104°F)
- ▶ Storage temperature: -40 to 60°C (-40 to 140°F)
- ▶ Humidity: 5 to 95% (noncondensing)



I/P high-performance pump head 77600-62 mounted on I/P process drive 77411-00



**2** year warranty

### ORDERING INFORMATION

Pump tubing size	Flow rates (at 1 to 650 rpm)	Polyester and SS housing, SS rotor	ATEX-approved; Polyester and SS housing, SS rotor
I/P 70	0.01 to 8 LPM		
I/P 88	0.02 to 17 LPM	<a href="#">HL-77600-62</a>	<a href="#">HL-77600-82</a>
I/P 89	0.03 to 19 LPM		

### I/P PUMP TUBING FLOW RATE INFORMATION

Order Masterflex I/P High-performance Precision pump tubing separately on page 128.

Tubing cross sections	I/P High-performance Precision tubing		
	I/P 70	I/P 88	I/P 89
Flow rate—mL/rev	12.3	26.2	29.2
Flow rate @ 650 rpm	8 LPM (2.1 GPM)	17 LPM (4.5 GPM)	19 LPM (5.0 GPM)
Max pressure†	2.7 bar (40 psi)	2.4 bar (35 psi)	1.4 bar (20 psi)
Max vacuum†	660 mm Hg (26" Hg)		610 mm Hg (24" Hg)
Suction lift	8.8 m H <sub>2</sub> O (29 ft H <sub>2</sub> O)		8.2 m H <sub>2</sub> O (27 ft H <sub>2</sub> O)

†Actual performance varies depending upon tubing materials—see pages 20–24 and 172–192 for more information.

### NOTES

Use only Masterflex pump tubing with Masterflex pumps to ensure optimal performance. Use of other tubing may void applicable warranties.



## SPECIFICATIONS for I/P High-Performance Pump Head

Catalog number	<a href="#">HL-77600-62</a> and <a href="#">HL-77600-82</a>	
<b>Performance Specifications</b>		
Flow capacity	0.01 to 19 LPM (0.002 to 5.0 GPM)	
Max rpm	650	
Number of rollers	3	
Max pressure	2.7 bar (40 psi)	
Max vacuum	660 mm Hg (26" Hg)	
Max suction lift	8.8 m H <sub>2</sub> O (29 ft H <sub>2</sub> O)	
<b>Torque Specifications [pumping water at 0 bar (0 psi), 21°C (70°F)]</b>		
Norprene® PharMed® BPT	Starting torque	658 N-cm (930 oz-in)
	Running torque	134 N-cm (190 oz-in)
Tygon®, Viton®	Starting torque	467 N-cm (660 oz-in)
	Running torque	130 N-cm (185 oz-in)
C-FLEX®, Silicone	Starting torque	357 N-cm (480 oz-in)
	Running torque	109 N-cm (155 oz-in)
<b>Physical Specifications</b>		
Roller/rotor assembly materials	Stainless steel	
Occlusion bed materials	Thermoset polyester	
Operating temperature	0 to 40°C (32 to 104°F)	
Shipping weight	3.2 kg (7 lb)	

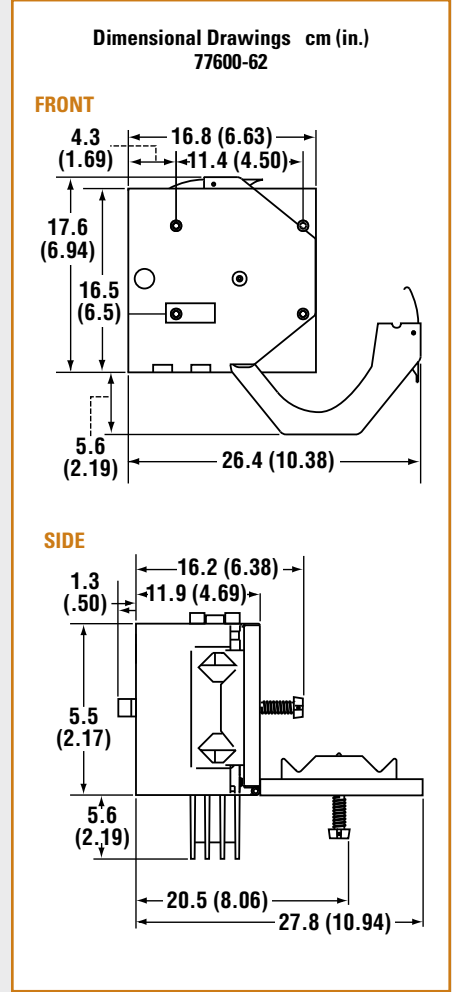

## DRIVE TORQUE REQUIREMENTS TO OBTAIN 19 LPM

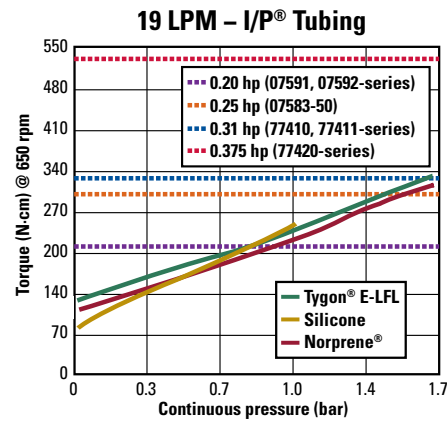

## HOW TO LOAD YOUR PUMP HEAD



1. Rotate tubing retainer knob counterclockwise to release retainer, then open cover. Lift latch to open occlusion bed.



2. Insert tubing into bed with both ends of the tubing extending through notches as shown.



3. Press occlusion bed against the tubing and snap the latch closed. Pull the tubing snug around the rotor, close the cover, and rotate the tubing retainer knob clockwise until the tube no longer moves.

## Watch the VIDEO!

For a video demonstration on how to load your I/P High-Performance Pump Head, go to . . . [Masterflex.com/video](http://Masterflex.com/video)



I/P® TUBING .....	126–130
I/P® DRIVES .....	131–145
I/P® PUMP SYSTEMS .....	146–151

ACCESSORIES..... 160–171

TECHNICAL DATA..... 172–206

## I/P® PRECISION PUMP TUBING

- ▶ Ensure optimal Masterflex® pump performance
- ▶ Custom extruded to fit Masterflex pumps
- ▶ Engineered for long life in peristaltic pumps
- ▶ Lot-to-lot consistency provides superior accuracy and repeatability

Masterflex I/P pump tubing is manufactured to extremely close tolerances that match our I/P pump heads, ensuring accurate, repeatable

flow and long tubing life. Our tubing is factory-tested and optically inspected to provide the best performance from your peristaltic pump.



Our High-Performance Precision pump tubing features a thicker wall compared to our Precision pump tubing, making it the best choice for applications involving pressure, suction lift, viscous fluids, or long tubing life. See page 128 to order.

### MORE online!

For help selecting the right Masterflex pump tubing formulation for your application, go to . . .

[ColeParmer.com/MasterflexTubing](http://ColeParmer.com/MasterflexTubing)



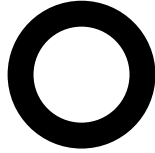



### SPECIFICATIONS

Pump tubing cross sections	I/P Precision pump tubing		
			
	I/P 26	I/P 73	I/P 82
Inside diameter (nominal)	6.4 mm (0.25")	9.5 mm (0.37")	12.7 mm (0.5")
Hose barb size (nominal)	6.4 mm (1/4")	9.5 mm (3/8")	12.7 mm (1/2")
Flow range (approximate) <sup>†</sup> with 1 to 650 rpm drive	0.01 to 4 LPM (0.002 to 1.1 GPM)	0.01 to 8 LPM (0.002 to 2.1 GPM)	0.02 to 13 LPM (0.005 to 3.5 GPM)
Maximum pressure <sup>‡</sup>	2.7 bar (40 psi)	2.7 bar (40 psi)	1.4 bar (20 psi)
Maximum vacuum <sup>†</sup>	660 mm Hg (26" Hg)	660 mm Hg (26" Hg)	510 mm Hg (20" Hg)
Suction lift <sup>†</sup>	8.8 m H <sub>2</sub> O (29 ft H <sub>2</sub> O)	8.8 m H <sub>2</sub> O (29 ft H <sub>2</sub> O)	7.0 m H <sub>2</sub> O (23 ft H <sub>2</sub> O)

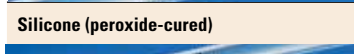
<sup>†</sup>Determined under the following conditions: 0 psi at inlet, 0.5 psi at outlet; water temperature at 22°C (72°F).

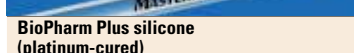
<sup>‡</sup>Actual performance varies depending on tubing formulation—values shown are for firm tubing. Value for GORE® pump tubing is 4.1 bar (60 psi) continuous.

### ORDERING INFORMATION

Pump tubing formulation	I/P Pump Head Compatibility		I/P 26	I/P 73	I/P 82
	Standard	Easy-Load®			
 Silicone (platinum-cured)	✓	✓	<a href="#">HL-96410-26</a> 7.6 m (25 ft)/pk	<a href="#">HL-96410-73</a> 7.6 m (25 ft)/pk	<a href="#">HL-96410-82</a> 7.6 m (25 ft)/pk
 Silicone (peroxide-cured)	✓	✓	<a href="#">HL-96400-26</a> 7.6 m (25 ft)/pk	<a href="#">HL-96400-73</a> 7.6 m (25 ft)/pk	<a href="#">HL-96400-82</a> 7.6 m (25 ft)/pk
 BioPharm silicone (platinum-cured)	✓	✓	<a href="#">HL-96420-26</a> 7.6 m (25 ft)/pk	<a href="#">HL-96420-73</a> 7.6 m (25 ft)/pk	<a href="#">HL-96420-82</a> 7.6 m (25 ft)/pk
 BioPharm Plus silicone (platinum-cured)	✓	✓	<a href="#">HL-96440-26</a> 7.6 m (25 ft)/pk	<a href="#">HL-96440-73</a> 7.6 m (25 ft)/pk	<a href="#">HL-96440-82</a> 7.6 m (25 ft)/pk
 Puri-Flex™	✓	✓	<a href="#">HL-96419-26</a> 7.6 m (25 ft)/pk	<a href="#">HL-96419-73</a> 7.6 m (25 ft)/pk	<a href="#">HL-96419-82</a> 7.6 m (25 ft)/pk
 C-Flex®	✓	✓	<a href="#">HL-06424-26</a> 7.6 m (25 ft)/pk	<a href="#">HL-06424-73</a> 7.6 m (25 ft)/pk	<a href="#">HL-06424-82</a> 7.6 m (25 ft)/pk
 C-Flex® ULTRA	✓	✓	<a href="#">HL-06434-26</a> 7.6 m (25 ft)/pk	<a href="#">HL-06434-73</a> 7.6 m (25 ft)/pk	<a href="#">HL-06434-82</a> 7.6 m (25 ft)/pk
 PharMed® BPT	✓	✓	<a href="#">HL-06508-26</a> 7.6 m (25 ft)/pk	<a href="#">HL-06508-73</a> 7.6 m (25 ft)/pk	<a href="#">HL-06508-82</a> 7.6 m (25 ft)/pk
 PharmaPure®		✓	<a href="#">HL-06435-26</a> 7.6 m (25 ft)/pk	<a href="#">HL-06435-73</a> 7.6 m (25 ft)/pk	<a href="#">HL-06435-82</a> 7.6 m (25 ft)/pk













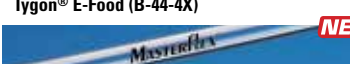
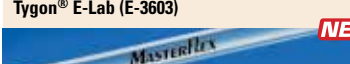

SEE PAGES 20 TO 24

For detailed formulation descriptions and specifications.

## ORDERING INFORMATION

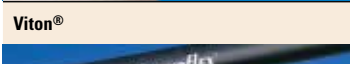
Pump tubing formulation	I/P Pump Head Compatibility		I/P 26	I/P 73	I/P 82
	Standard	Easy-Load®			
Chem-Durance® Bio 		✓	<a href="#">HL-06442-26</a> 15.2 m (50 ft)/pk	<a href="#">HL-06442-73</a> 15.2 m (50 ft)/pk	<a href="#">HL-06442-82</a> 15.2 m (50 ft)/pk
Tygon® E-LFL 	<b>NEW</b> ✓	✓	<a href="#">HL-06440-26</a> 7.6 m (25 ft)/pk	<a href="#">HL-06440-73</a> 7.6 m (25 ft)/pk	<a href="#">HL-06440-82</a> 7.6 m (25 ft)/pk
Tygon® E-Food (B-44-4X) 	<b>NEW</b> ✓	✓	<a href="#">HL-06418-26</a> 15.2 m (50 ft)/pk	<a href="#">HL-06418-73</a> 15.2 m (50 ft)/pk	<a href="#">HL-06418-82</a> 15.2 m (50 ft)/pk
Tygon® E-Lab (E-3603) 	<b>NEW</b> ✓	✓	<a href="#">HL-06509-26</a> 15.2 m (50 ft)/pk	<a href="#">HL-06509-73</a> 15.2 m (50 ft)/pk	<a href="#">HL-06509-82</a> 15.2 m (50 ft)/pk
Tygon® Fuel & Lubricant (F-4040-A) 	✓	✓	—	<a href="#">HL-06401-73</a> 15.2 m (50 ft)/pk	<a href="#">HL-06401-82</a> 15.2 m (50 ft)/pk
Tygon® Chemical (2001) 		✓	<a href="#">HL-06475-26</a> 15.2 m (50 ft)/pk	<a href="#">HL-06475-73</a> 15.2 m (50 ft)/pk	<a href="#">HL-06475-82</a> 15.2 m (50 ft)/pk
Norprene® (A 60 G) 	✓	✓	<a href="#">HL-06404-26</a> 15.2 m (50 ft)/pk	<a href="#">HL-06404-73</a> 15.2 m (50 ft)/pk	<a href="#">HL-06404-82</a> 15.2 m (50 ft)/pk
Norprene® Food (A 60 F) 	✓	✓	<a href="#">HL-06402-26</a> 15.2 m (50 ft)/pk	<a href="#">HL-06402-73</a> 15.2 m (50 ft)/pk	<a href="#">HL-06402-82</a> 15.2 m (50 ft)/pk
GORE® Style 100SC 	✓	✓	<a href="#">HL-96190-26</a> 61 cm (24")/pk	<a href="#">HL-96190-73</a> 61 cm (24")/pk	<a href="#">HL-96190-82</a> 61 cm (24")/pk
GORE® Style 500 	✓	✓	<a href="#">HL-96191-26</a> 61 cm (24")/pk	<a href="#">HL-96191-73</a> 61 cm (24")/pk	<a href="#">HL-96191-82</a> 61 cm (24")/pk
GORE® Style 400 	✓	✓	—	<a href="#">HL-06439-73</a> 61 cm (24")/pk	—
Viton® 	✓	✓	<a href="#">HL-96412-26</a> 7.6 m (25 ft)/pk	<a href="#">HL-96412-73</a> 7.6 m (25 ft)/pk	—



## FILLER/DISPENSING NOZZLES

- ▶ Maximize the speed, precision, and accuracy of dispensing and filling applications
- ▶ Minimize splashing and dripping when dispensing into narrow- or wide-mouth containers
- ▶ Dimensional tolerances of ±0.05% for assured repeatability

These nozzles combine the ease of plastic components with the accuracy and reliability of stainless steel filler needles. Tight dimensional tolerances help to ensure precision in your dispensing applications. Nozzles feature a 316L stainless steel tube and a polycarbonate base with hose barb adapter. Materials comply with FDA, USDA and USP Class VI requirements. All filler nozzles are sterilizable by ethylene oxide, autoclaving, or gamma irradiation.

30619-08

Catalog number	Tubing ID	Fits Masterflex® tubing sizes
<a href="#">HL-30619-06</a>	1/32"	L/S® 13
<a href="#">HL-30619-01</a>	1/16"	L/S 14
<a href="#">HL-30619-07</a>	1/8"	L/S 16
<a href="#">HL-30619-02</a>	3/16"	L/S 15, 25
<a href="#">HL-30619-08</a>	1/4"	L/S 17, 24; I/P® 26
<a href="#">HL-30619-03</a>	5/16"	L/S 35
<a href="#">HL-30619-09</a>	3/8"	L/S 18, 36; I/P 70, 73; B/T® 86
<a href="#">HL-30619-04</a>	1/2"	I/P 82, 88; B/T 87
<a href="#">HL-30619-10</a>	5/8"	I/P 89
<a href="#">HL-30619-05</a>	3/4"	B/T 91

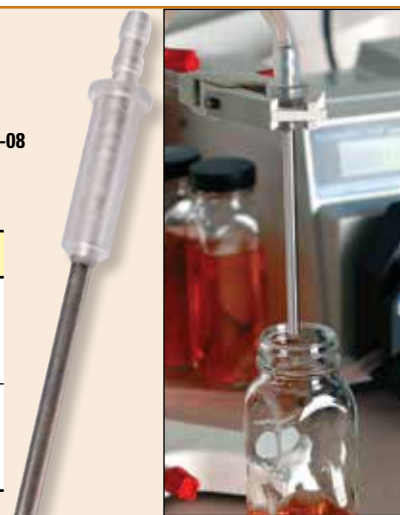

## I/P® HIGH-PERFORMANCE PRECISION PUMP TUBING

Our High-Performance Precision pump tubing features a thicker wall compared to our Precision pump tubing, making it the best choice for applications involving pressure, suction lift, viscous fluids, or long tubing life.



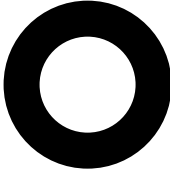
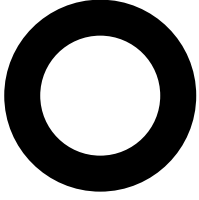







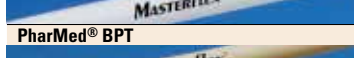

### SPECIFICATIONS

Pump tubing cross sections	I/P High-performance Precision pump tubing		
			
	I/P 70	I/P 88	I/P 89
Inside diameter (nominal)	9.5 mm (0.37")	12.7 mm (0.5")	15.88 mm (0.62")
Hose barb size (nominal)	9.5 mm (3/8")	12.7 mm (1/2")	15.88 mm (5/8")
Flow range (approximate) <sup>†</sup> with 1 to 650 rpm drive	0.01 to 8 LPM (0.002 to 2.1 GPM)	0.02 to 17 LPM (0.005 to 4.5 GPM)	0.03 to 19 LPM (0.007 to 5.0 GPM)
Maximum pressure <sup>‡</sup>	2.7 bar (40 psi)	2.4 bar (35 psi)	1.4 bar (20 psi)
Maximum vacuum <sup>‡</sup>	660 mm Hg (26" Hg)	660 mm Hg (26" Hg)	610 mm Hg (24" Hg)
Suction lift <sup>‡</sup>	8.8 m H <sub>2</sub> O (29 ft H <sub>2</sub> O)	8.8 m H <sub>2</sub> O (29 ft H <sub>2</sub> O)	8.2 m H <sub>2</sub> O (27 ft H <sub>2</sub> O)

<sup>†</sup>Determined under the following conditions: 0 psi at inlet, 0.5 psi at outlet; water temperature at 22°C (72°F).

<sup>‡</sup>Actual performance varies depending on tubing formulation—values shown are for firm tubing.

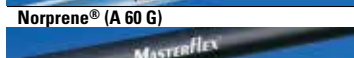
### ORDERING INFORMATION

Pump tubing formulation	I/P Pump Head Compatibility			
	High-Performance	I/P 70	I/P 88	I/P 89
Silicone (platinum-cured)	✓	—	<a href="#">HL-96510-88</a> 3.0 m (10 ft)/pk	<a href="#">HL-96510-89</a> 3.0 m (10 ft)/pk
 BioPharm silicone (platinum-cured)	✓	<a href="#">HL-96421-70</a> 3.0 m (10 ft)/pk	<a href="#">HL-96421-88</a> 3.0 m (10 ft)/pk	<a href="#">HL-96421-89</a> 3.0 m (10 ft)/pk
 BioPharm Plus silicone (platinum-cured)	✓	<a href="#">HL-96441-70</a> 3.0 m (10 ft)/pk	<a href="#">HL-96441-88</a> 3.0 m (10 ft)/pk	<a href="#">HL-96441-89</a> 3.0 m (10 ft)/pk
 Puri-Flex™	✓	<a href="#">HL-96419-70</a> 3.0 m (10 ft)/pk	<a href="#">HL-96419-88</a> 3.0 m (10 ft)/pk	<a href="#">HL-96419-89</a> 3.0 m (10 ft)/pk
 C-Flex®	✓	<a href="#">HL-06424-70</a> 3.0 m (10 ft)/pk	<a href="#">HL-06424-88</a> 3.0 m (10 ft)/pk	<a href="#">HL-06424-89</a> 3.0 m (10 ft)/pk
 PharMed® BPT	✓	<a href="#">HL-06508-70</a> 7.6 m (25 ft)/pk	<a href="#">HL-06508-88</a> 7.6 m (25 ft)/pk	—
 Chem-Durance® Bio	✓	<a href="#">HL-06442-70</a> 7.6 m (25 ft)/pk	<a href="#">HL-06442-88</a> 7.6 m (25 ft)/pk	<a href="#">HL-06442-89</a> 7.6 m (25 ft)/pk
 Tygon® E-LFL <b>NEW</b>	✓	<a href="#">HL-06440-70</a> 7.6 m (25 ft)/pk	<a href="#">HL-06440-88</a> 7.6 m (25 ft)/pk	<a href="#">HL-06440-89</a> 7.6 m (25 ft)/pk
 Tygon® E-Food (B44-4X) <b>NEW</b>	✓	<a href="#">HL-06418-70</a> 15.2 m (50 ft)/pk	<a href="#">HL-06418-88</a> 15.2 m (50 ft)/pk	<a href="#">HL-06418-89</a> 15.2 m (50 ft)/pk
 Tygon® E-Lab (E-3603) <b>NEW</b>	✓	<a href="#">HL-06509-70</a> 15.2 m (50 ft)/pk	<a href="#">HL-06509-88</a> 15.2 m (50 ft)/pk	<a href="#">HL-06509-89</a> 15.2 m (50 ft)/pk
 Norprene® (A 60 G)	✓	<a href="#">HL-06404-70</a> 7.6 m (25 ft)/pk	<a href="#">HL-06404-88</a> 7.6 m (25 ft)/pk	<a href="#">HL-06404-89</a> 7.6 m (25 ft)/pk
 Norprene® Food (A 60 F)	✓	—	<a href="#">HL-06402-88</a> 7.6 m (25 ft)/pk	<a href="#">HL-06402-89</a> 7.6 m (25 ft)/pk
 GORE® Style 100SC	✓	—	<a href="#">HL-96190-88</a> 61 cm (24")/pk	<a href="#">HL-96190-89</a> 61 cm (24")/pk
 GORE® Style 500	✓	—	<a href="#">HL-96191-88</a> 61 cm (24")/pk	<a href="#">HL-96191-89</a> 61 cm (24")/pk
 GORE® Style 400	✓	—	<a href="#">HL-06439-88</a> 61 cm (24")/pk	—



## I/P® SANITARY PUMP TUBING ASSEMBLIES

### FEATURES/BENEFITS

- ▶ Ideal for biotech, pharmaceutical, food, beverage, and dairy processing applications
- ▶ Pre-molded tubing ends with ½" mini-connection for bacteria-free fluid transfer
- ▶ Sanitary tubing is less thermally conductive than metallic tubing systems and not subject to galvanic action, RFI, or EMI

### HOW TO CONNECT TUBING

- ▶ Each length of tubing features pre-molded ends with ½" mini-connection. One end has molded-in gasket to ensure quality seal
- ▶ Pre-molded ends allow quick connection to an adapter or to additional length of sanitary tubing
- ▶ Join ½" mini-connection to another ½" mini-connection, adapter, or to system with a push/pull clamp. Clamped connection withstands greater pressures than tubing.

### HOW TO ORDER

1. Order your desired tubing formulation and length. Choose tubing size based on flow range (see chart on pages 126 and 128).
2. Order PVDF push/pull clamp (separately below).
3. Order silicone or Viton® gaskets as needed to connect to your system or to adapters.
4. Select sanitary adapters as needed.



I/P PharMed® BPT sanitary tubing features pre-molded ends with ½" mini-connection

### ORDERING INFORMATION

Tubing size	Platinum-cured silicone (96410-series) 1.5-m (5-ft) length	Platinum-cured silicone (96410-series) 3-m (10-ft) length	PharMed® BPT (06508-series) 1.5-m (5-ft) length	PharMed® BPT (06508-series) 3-m (10-ft) length
	Catalog number	Catalog number	Catalog number	Catalog number
<b>I/P Precision sanitary pump tubing</b>				
I/P 26	<a href="#">HL-96100-26</a>	<a href="#">HL-96101-26</a>	<a href="#">HL-96112-26</a>	<a href="#">HL-96113-26</a>
I/P 73	<a href="#">HL-96100-73</a>	<a href="#">HL-96101-73</a>	<a href="#">HL-96112-73</a>	<a href="#">HL-96113-73</a>
I/P 82	<a href="#">HL-96100-82</a>	<a href="#">HL-96101-82</a>	<a href="#">HL-96112-82</a>	<a href="#">HL-96113-82</a>
<b>I/P High-performance Precision sanitary pump tubing</b>				
I/P 70	—	—	<a href="#">HL-96112-70</a>	<a href="#">HL-96113-70</a>
I/P 88	—	—	<a href="#">HL-96112-88</a>	<a href="#">HL-96113-88</a>
I/P 89	—	—	<a href="#">HL-96112-89</a>	<a href="#">HL-96113-89</a>

### ACCESSORIES FOR I/P SANITARY PUMP TUBING

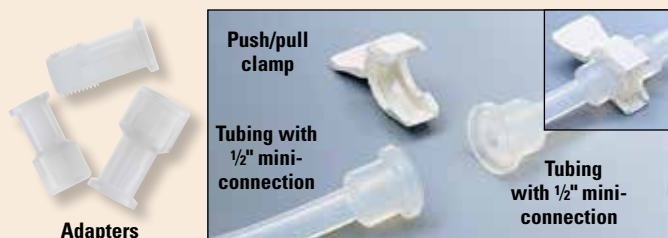

**HL-31201-88 Push/pull clamp**, PVDF. For quick joining of two ½" mini connections.

**Gaskets.** Order gaskets to join ½" mini connection without molded-in gasket to another ½" mini connection without molded-in gasket or to an adapter (sold separately below).

**HL-30548-00 Silicone gasket** for use with sanitary silicone (platinum-cured) tubing. Pack of 10.

**HL-30548-20 Viton® gasket** for use with sanitary PharMed® BPT tubing. Pack of 10.

### ADAPTER ORDERING INFORMATION

Adapter connections	Polypropylene	PVDF
	Catalog number	Catalog number
½" mini to ¼" NPT(M)	<a href="#">HL-31200-01</a>	<a href="#">HL-31201-01</a>
½" mini to ¼" NPT(F)	<a href="#">HL-31200-11</a>	<a href="#">HL-31201-11</a>
½" mini to ¼" hose barb	<a href="#">HL-31805-25</a>	<a href="#">HL-31808-25</a>
½" mini to ⅜" NPT(M)	<a href="#">HL-31200-02</a>	<a href="#">HL-31201-02</a>
½" mini to ⅜" NPT(F)	<a href="#">HL-31200-12</a>	<a href="#">HL-31201-12</a>
½" mini to ⅜" hose barb	<a href="#">HL-31805-26</a>	<a href="#">HL-31808-26</a>
½" mini to ½" NPT(M)	<a href="#">HL-31200-03</a>	<a href="#">HL-31201-03</a>
½" mini to ½" NPT(F)	<a href="#">HL-31200-13</a>	<a href="#">HL-31201-13</a>
½" mini to 1" Iadish	<a href="#">HL-31805-05</a>	<a href="#">HL-31201-40</a>
½" mini to female luer lock	<a href="#">HL-31200-50</a>	<a href="#">HL-31201-50</a>

### NOTES

- ▶ Consider all aspects of your application: flow rate, pressure, viscosity, etc.
- ▶ If your application requires the generation of high pressure, a strong vacuum/suction lift, or involves viscous fluids, consider using High-performance Precision tubing.

**Note:** Use High-performance Precision tubing only with the High-performance pump head.

- ▶ Norprene®, PharMed® BPT, and Tygon® are the firmest formulations we offer; C-FLEX® and silicone are the softest. Firm tubing has better pressure generation, stronger vacuum/suction lift, and lower gas permeability.
- ▶ Review the tubing compatibility charts on pages 30–31 and specific information on tubing materials on pages 20–24.
- ▶ Always test tubing before extended use: see page 31 for tubing testing procedures.

## I/P® SPOOLED PUMP TUBING

- ▶ Continuous lengths of tubing are convenient and cost-effective
- ▶ Spools contain up to 121.9 m (400 ft) of continuous pump tubing, depending on size
- ▶ Eliminate waste by cutting to the exact length needed for your application
- ▶ Save space and shipping costs by buying in bulk
- ▶ Good choice for applications requiring long, continuous runs of tubing, or which use odd-size lengths that generate scrap when using standard 7.6- or 15.2-m (25- or 50-ft) coils



**Save Money  
and Reduce  
Downtime!**

**SEE PAGE 73**

Order L/S® spooled and bulk tubing on page 73.

### TECHNICAL INFO

For technical information about our Masterflex® pump tubing formulations, go to pages 20–31.

96403-26

### ORDERING INFORMATION

Tubing size	Peroxide-cured silicone (96400-series)		Platinum-cured silicone (96410-series)		PharMed® BPT (06508-series)		BioPharm Silicone (96420-series)		C-Flex® (06424-series)	
	m (ft)	Catalog number	m (ft)	Catalog number	m (ft)	Catalog number	m (ft)	Catalog number	m (ft)	Catalog number
I/P 26	—	—	61.0 (200)	<a href="#">HL-96403-26</a>	61.0 (200)	—	121.9 (400)	<a href="#">HL-96423-26</a>	121.9 (400)	<a href="#">HL-06427-26</a>
I/P 73	45.7 (150)	<a href="#">HL-96402-73</a>	45.7 (150)	<a href="#">HL-96403-73</a>	45.7 (150)	<a href="#">HL-95687-73</a>	30.5 (100)	<a href="#">HL-96423-73</a>	30.5 (100)	<a href="#">HL-06427-73</a>
I/P 82	30.5 (100)	<a href="#">HL-96402-82</a>	30.5 (100)	<a href="#">HL-96403-82</a>	30.5 (100)	<a href="#">HL-95687-82</a>	—	—	30.5 (100)	<a href="#">HL-06427-82</a>
I/P 88	—	—	—	—	—	—	30.5 (100)	<a href="#">HL-96423-88</a>	—	—
I/P 89	—	—	—	—	—	—	30.5 (100)	<a href="#">HL-96423-89</a>	—	—

## I/P® BULK-PACKED PUMP TUBING

- ▶ Save money and always have enough tubing on hand
- ▶ Tubing coils are individually bagged and sealed to prevent contamination
- ▶ Use as many or as few as you need, and store the rest
- ▶ Save money by buying and shipping in bulk
- ▶ Bulk packs contain ten individually bagged, sealed 7.6-m (25-ft) coils of tubing, all from a single manufacturing lot

### ORDERING INFORMATION

Tubing size	Number of 7.6-m (25-ft) bags per box	Platinum-cured silicone (96410-series)	PharMed® BPT (06508-series)	C-Flex® (06424-series)
		Catalog number	Catalog number	Catalog number
I/P 26	10	<a href="#">HL-96404-26</a>	—	<a href="#">HL-06436-26</a>
I/P 73	10	<a href="#">HL-96404-73</a>	—	<a href="#">HL-06436-73</a>
I/P 82	10	<a href="#">HL-96404-82</a>	<a href="#">HL-95691-82</a>	<a href="#">HL-06436-82</a>



**Bulk packs offer individually sealed bags of tubing at a lower price per pack than individual packs—so you save money!**

## PURE-FIT® TC TUBING CLAMPS

**Install easily over existing tubing lines or assemblies**



- ▶ Smooth contours eliminate risk of puncture or rupture
- ▶ Fully sterilizable
- ▶ Meet USP Class IV criteria

The Pure-Fit TC clamp has a press-down locking mechanism that provides complete fluid stoppage. Its side-release mechanism ensures against unwanted opening. The open design can be installed over existing fittings or finished tubing assemblies, eliminating costly downtime. Available sizes handle two tubing ranges.

Available in polypropylene (PP) or PVDF. Sterilize PP by gamma irradiation only; PVDF may be sterilized by gamma irradiation or autoclaving. Sold in pack of 10.

Catalog number	Fits Masterflex® tubing sizes	Material
<a href="#">HL-06822-01</a>	L/S® 13, 14, 15, 16, 17, 25	Polypropylene
<a href="#">HL-06822-03</a>		PVDF
<a href="#">HL-06822-11</a>	L/S 18, 24, 35, 36; I/P® 26, 70, 73, 82	Polypropylene
<a href="#">HL-06822-13</a>		PVDF



## SELECTION GUIDE FOR IP<sup>®</sup>DRIVES

	Description	Max flow rate	Fixed speed (rpm)	Variable speed (rpm)	Reversible	Remote control capabilities	Special features	Page number	
Digital	<b>MODULAR</b>								
	 <b>NEW</b>	Up to 19 LPM (5.0 GPM) with one pump head; up to 26 LPM (6.9 GPM) with two Standard or Easy-Load pump heads (silicone or C-FLEX® tubing only)	—	6 to 650	✓	Speed (some models)	Separate motor and controller for convenient set-up; models available with wall-mount controller and IP66 protection	132–133	
		Up to 19 LPM (5.0 GPM) with one pump head; up to 26 LPM (6.9 GPM) with two Standard or Easy-Load® pump heads with any tubing formulation	—	33 to 650	✓	Speed, direction, start/stop (some models)	Compact and powerful; maintenance-free brushless motor; IP55 rated	134–137	
	<b>MODULAR DISPENSING</b>								
 <b>NEW</b>	Up to 19 LPM (5.0 GPM) with one pump head; up to 26 LPM (6.9 GPM) with two Standard or Easy-Load pump heads	—	0.1 to 650	✓	Speed, direction, start/stop, prime	Digital dispensing with calibration; separate motor and controller for convenient setup; models available with wall-mount controllers and IP66 protection	138–139		
Specialty	<b>DIGITAL PROCESS</b>								
	 <b>NEW</b>	Up to 19 LPM (5.0 GPM) with one pump head; up to 26 LPM (6.9 GPM) with two Standard or Easy-Load pump heads with any tubing formulation	—	0.1 to 650	✓	Speed, direction, start/stop, prime	Digital dispensing with calibration; sealed, seamless enclosure; NEMA 4X and IP66 rated; maintenance-free brushless motor	140–141	
	<b>AIR-POWERED</b>								
	Up to 19 LPM (5.0 GPM) with one pump head; up to 26 LPM (6.9 GPM) with two Standard or Easy-Load pump heads	—	100 to 650	—	—	—	Use where electricity is unsafe or impractical. ATEX Zone 2 approved.	142	
Specialty	<b>FIXED-SPEED AND MULTICHANNEL</b>								
		Up to 15.8 LPM (4.2 GPM) with one pump head; up to 22 LPM (5.8 GPM) with two Easy-Load pump heads	83, 100, 450, 540	—	✓	—	Economical and simple to operate; up to four channels	143	
	<b>HAZARDOUS-DUTY</b>								
	Up to 12.6 LPM (3.3 GPM) with one pump head; up to 17 LPM (4.5 GPM) with two Standard or Easy-Load pump heads	—	10 to 430	—	—	—	Agency certified for use in hazardous locations	144	
<b>PUMP HEAD ADAPTERS</b>									
	Flow rates and features depend on motor selection						Allows you to use 56C motors with Masterflex® pump heads	145	

## I/P® PRECISION MODULAR DRIVES



**Modular drive with benchtop controller 07591-20**

**NEW**



**Modular drive 07591-30 with wall-mount controller shown with Easy-Load® pump head 77601-10**

### FEATURES/BENEFITS

- ▶ Flow rates: 0.036 to 19 LPM (0.009 to 5 GPM) with I/P tubing
- ▶ Modular format lets you separate drive and controller for convenient placement; a 1.8-m (6-ft) control cable is included. Extend that distance with optional 2.7-m (9-ft) extension cable
- ▶ Three-digit LED shows motor speed (rpm)—confirm speed setting at a glance
- ▶ PWM speed control for precise, efficient control; ±0.25% speed control accuracy
- ▶ Reversible motor—easily reverse direction of flow to purge or prime tubing
- ▶ Universal voltage, 90 to 260 VAC autoselect, 50/60 Hz
- ▶ Compatible with all I/P pump heads

### DRIVE CONTROLS

- ▶ Protected power switch located on controller
- ▶ Lighted display indicates power is on
- ▶ LED indicator shows motor/pumping direction
- ▶ Simple programming and operation of the following via sealed membrane keypad:
  - ◆ Flow direction
  - ◆ Motor speed (rpm)
  - ◆ Control mode (remote/internal)
  - ◆ Start/stop

### SETUP

1. Mount pump head(s) and load tubing.
2. Connect drive cable to controller.
3. Turn drive power on.
4. Select manual (internal) or remote (external) control.
5. Select motor direction.
6. Set drive speed (rpm) through keypad.
7. Press START key to begin pumping.

### SPEED CONTROL/CIRCUITRY

- ▶ Regulate motor through keypad, 4 to 20 mA, or 0 to 10 V signal
- ▶ Soft start for starts without power surges
- ▶ Speed not affected by variations in power line voltage (VAC) or frequency (Hz)
- ▶ Line filters reduce outside interference
- ▶ Meets UL 61010-1, CAN/CSA C22.2, No. 61010-1; For CE mark: EN61010-1 (EU low voltage) and EN61326-1 (EU EMC)

### SELECTION CRITERIA

1. Motor rpm / flow rate.
  2. Benchtop or washdown, wall-mount controller.
- Order pump heads and tubing separately.**

### REMOTE CONTROL

#### Benchtop Modular Drive

- ▶ Remote control via 9-pin (DB9) female connection on back of controller
- ▶ Speed control input: 4 to 20 mA and 0 to 10 V
- ▶ START/STOP, CW/CCW via contact closure
- ▶ Handheld remote, cable, and foot switch options; order separately under "Accessories"

#### Modular Drive with Washdown, Wall-Mount Controller

- ▶ Remote control via 18-pin weather-resistant circular connection on bottom of controller
- ▶ Speed control input: 4 to 20 mA and 0 to 10 V
- ▶ START/STOP, CW/CCW via contact closure
- ▶ Remote cable and foot switch options; order separately under "Accessories"

ISO9001:2008  
CERTIFIED SUPPLIER



2 year  
warranty

07591-30

### ORDERING INFORMATION

Catalog number	rpm	Power (50/60 Hz)
<b>Benchtop precision modular drive</b>		
<a href="#">HL-07591-20</a>	6 to 650	90 to 260 VAC
<b>Precision modular drive with washdown controller</b>		
<a href="#">HL-07591-30</a>	6 to 650	90 to 260 VAC

### I/P PUMP TUBING FLOW RATE INFORMATION

Order Masterflex I/P tubing separately on pages 126–130.

**STANDARD**  
0.06 to 13 LPM  
pages 120–121



**EASY-LOAD®**  
0.04 to 13 LPM  
pages 122–123



**HIGH-PERFORMANCE**  
0.08 to 19 LPM  
pages 124–125



Tubing cross sections	I/P Precision pump tubing			I/P High-Performance Precision pump tubing†		
	<b>I/P 26</b>	<b>I/P 73</b>	<b>I/P 82</b>	<b>I/P 70</b>	<b>I/P 88</b>	<b>I/P 89</b>
Flow range @ 6 to 650 rpm	0.04 to 4.0 LPM (0.01 to 1.0 GPM)	0.06 to 8.0 LPM (0.02 to 2.1 GPM)	0.12 to 13 LPM (0.03 to 3.5 GPM)	0.08 to 8.0 LPM (0.02 to 2.1 GPM)	0.12 to 17 LPM (0.03 to 4.5 GPM)	0.16 to 19 LPM (0.04 to 5.0 GPM)

†Use High-performance Precision tubing with High-Performance pump head. Flow rates were determined using water at room temperature and with zero back pressure and zero suction lift.



## ACCESSORIES

### For Benchtop Model 07591-20

**HL-07557-51** Extension cable, 2.7 m (9 ft), to extend distance between motor and controller.

**HL-07595-47** Cable assembly, DB9 male connector and 7.9-m (25-ft) cable with stripped wire terminal ends. Use for remote control.

**HL-77595-35** Foot switch, DB9 male with 1.8-m (6-ft) cable.

**HL-17050-01** NIST-traceable calibration with data for peristaltic pump drive.

### For Washdown Model 07591-30

**HL-07557-51** Extension cable, 2.7 m (9 ft), to extend distance between motor and controller.

**HL-77300-32** Cable assembly, 18-pin round connector and 7.9-m (25-ft) cable with stripped wire terminal ends. Use for remote control.

**HL-07595-43** Washdown foot switch, 18-pin round with 1.8-m (6-ft) cable.

**HL-17050-01** NIST-traceable calibration with data for peristaltic pump drive.

## SPECIFICATIONS for I/P Precision Modular Drives

Catalog number		HL-07591-20	HL-07591-30
<b>Performance Specifications</b>			
Flow capacity <sup>†</sup>		0.036 to 19 LPM (0.009 to 5 GPM)	
rpm		6 to 650	
Number of heads accepted		2	
Maximum torque	Starting	635 N-cm (900 oz-in)	
	Running	212 N-cm (300 oz-in)	
Reversible		Yes	
External control – Input		4 to 20 mA, 0 to 10 V; START/STOP, CW/CCW via contact closure	
External control – Output		Not applicable	
<b>Electrical Specifications</b>			
Voltage/Frequency VAC (Hz)		90 to 260 (50/60)	
Current		4.4 A at 115 V; 2.2 A at 230 V	
Fuse rating		6.3 A / 250 V	
Motor type		Continuous-duty, TENV <sup>‡</sup> , permanent magnet DC	
Motor size		149 W (1/2 hp)	
Display		Three-digit LED	
Motor/speed control type		PWM	
Speed regulation		±0.25%	
Soft start/Electronic brake		Yes/No	
<b>Physical Specifications</b>			
Housing materials	Drive	Painted steel and aluminum	Painted steel and aluminum
	Controller	ABS plastic housing, coated aluminum chassis	Painted aluminum
IP rating <sup>††</sup>		IP33	IP66 (NEMA 4X)
Agency listings		ETL, cETL, CE	
Operating temperature		0 to 40°C (32 to 104°F)	
Storage temperature		-25 to 65°C (-13 to 149°F)	
Dimensions (L x W x H)	Drive	35.3 x 13.9 x 15.6 cm (13 7/8" x 5 1/2" x 6 1/8")	36.2 x 17.8 x 16.5 cm (14 1/4" x 7" x 6 1/2")
	Controller	26.3 x 21.1 x 14.0 cm (10 3/8" x 8 3/8" x 5 1/2")	28.5 x 27.9 x 11.9 cm (10 1/2" x 11" x 4 3/4")
Shipping weight		9.9 kg (21.8 lb)	18.0 kg (39.7 lb)

<sup>†</sup>Depending on drive rpm and tubing size.

<sup>‡</sup>Totally enclosed, nonventilating.

<sup>††</sup>See page 194 for an explanation of IP ratings.

## Dimensional Drawings cm (in.)

### 07591-20 Controller

#### FRONT

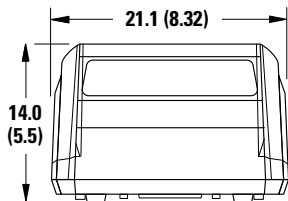

#### SIDE

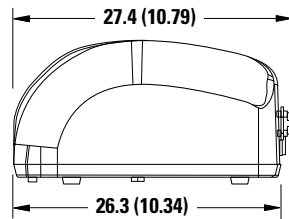

### 07591-20 Drive

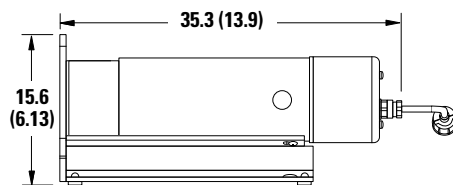
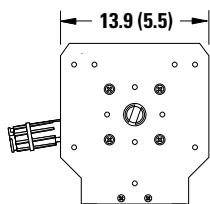

### 07591-30 Controller

#### FRONT

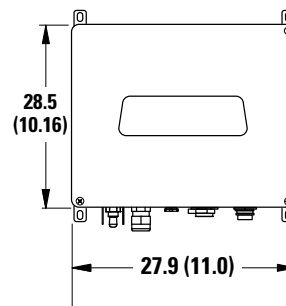

#### SIDE

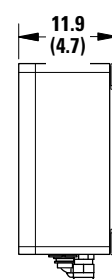

### 07591-30 Drive

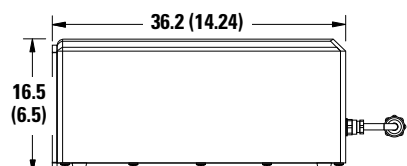
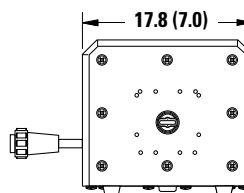

## I/P® BRUSHLESS PROCESS DRIVE

### FEATURES/BENEFITS

- ▶ 1/3-hp brushless motors handle challenging applications with minimal maintenance
- ▶ Nonchip epoxy-coated, IP55-rated steel enclosure protects against moisture, chemicals, and dust
- ▶ 1% speed resolution
- ▶ Compact drives are light enough to carry with one hand, but powerful enough to drive two pump heads
- ▶ Easy-to-read LED display
- ▶ Convenient carrying handle allows for easy portability
- ▶ Low-maintenance drives have no motor brushes to replace
- ▶ Reversible motor—pump in either direction
- ▶ Control speed via a three-turn potentiometer for quick, easy adjustments
- ▶ CW/CCW and start/stop via sealed keypad
- ▶ Motor speed is displayed from 5 to 100% via a digital display

### DRIVE/SPEED CONTROLS

- ▶ Protected power switch located on back of drive
- ▶ Lighted display indicates power is on
- ▶ Control the speed and direction of the flow via the following:
  - ◆ STOP/START
  - ◆ DIRECTION
  - ◆ SPEED

### SETUP

1. Mount pump head(s) and load tubing.
2. Turn drive power on.
3. Select pump DIRection (clockwise or counter-clockwise).
4. Press STOP/START key to begin pumping.
5. Adjust speed to achieve desired flow rate.



I/P brushless process drive 77410-10 shown with I/P Easy-Load pump head 77601-10

### SPEED CONTROL/CIRCUITRY

- ▶ Regulate motor speed from 5 to 100% via the analog button (clockwise rotation increases speed)
- ▶ Speed not affected by variations in line voltage (VAC) or frequency (Hz)
- ▶ Line filters reduce outside interference
- ▶ Meets UL 508C, CSA C22.2, No. 14, EN61010-1 and EN61326-1 (for CE)

### PUMP HEADS ACCEPTED

- ▶ Accepts three different pump head types: Standard, Easy-Load®, and High-Performance

### NOTES

This brushless process drive supplies enough torque to drive two pump heads using any tubing formulation.

ISO9001:2008  
CERTIFIED SUPPLIER



2 year  
warranty

### ORDERING INFORMATION

Catalog number	rpm	Power (50/60 Hz)
<a href="#">HL-77410-10</a>	33 to 650	90 to 260 VAC

### ACCESSORIES

[HL-17050-01](#) NIST-traceable calibration for peristaltic pump drive.

### I/P PUMP TUBING

#### FLOW RATE INFORMATION

Order Masterflex I/P tubing separately on pages 126–130.

STANDARD  
0.40 to 13 LPM  
pages 120–121



EASY-LOAD®  
0.20 to 13 LPM  
pages 122–123



HIGH-PERFORMANCE  
0.40 to 19 LPM  
pages 124–125



Tubing cross sections	I/P Precision pump tubing			I/P High-performance Precision pump tubing†		
	I/P 26	I/P 73	I/P 82	I/P 70	I/P 88	I/P 89
Flow range @ 33 to 650 rpm	0.20 to 4.0 LPM (0.06 to 1.0 GPM)	0.40 to 8.0 LPM (0.11 to 2.1 GPM)	0.66 to 13 LPM (0.17 to 3.5 GPM)	0.40 to 8.0 LPM (0.11 to 2.1 GPM)	0.66 to 17 LPM (0.17 to 4.5 GPM)	0.86 to 19 LPM (0.23 to 5.0 GPM)

†Use High-performance precision tubing with High-Performance pump head only. Flow rates were determined using water at room temperature and with zero back pressure and suction lift.





### SPECIFICATIONS for I/P Analog Brushless Process Drive

Catalog number	<a href="#">HL-77410-10</a>	
<b>Performance Specifications</b>		
Flow capacity	0.2 to 19 LPM (0.06 to 5.0 GPM)	
rpm	33 to 650	
Number of heads accepted	2	
Maximum torque	Starting	678 N-cm (960 oz-in)
	Running	382 N-cm (540 oz-in)
Reversible	Yes	
External control	Input	Not applicable
	Output	Not applicable
<b>Electrical Specifications</b>		
Voltage/Frequency VAC (50/60 Hz)	90 to 130 and 220 to 260, dual-voltage autoselecting	
Current	4.5 A at 115 VAC; 2.6 A at 230 VAC	
Fuse rating	6.3 A / 250 V	
Motor type	Continuous-duty, brushless DC	
Motor size	0.25 kW (1/3 hp)	
Display	Three-digit, seven-segment LED	
Motor/speed control type	Three-turn potentiometer	
Speed regulation (repeatability)	±0.25%	
Soft start/Electronic brake	Yes/Yes	
<b>Physical Specifications</b>		
Housing materials	Painted steel	
IP rating <sup>‡</sup>	IP55	
Agency listings	UL, cUL, CE	
Operating temperature	0 to 40°C (32 to 104°F)	
Storage temperature	-25 to 65°C (-13 to 149°F)	
Dimensions (L x W x H)	35 x 25 x 23 cm (14" x 10" x 9 1/8")	
Shipping weight	10 kg (22 lb)	

<sup>‡</sup>See page 194 for an explanation of IP ratings.

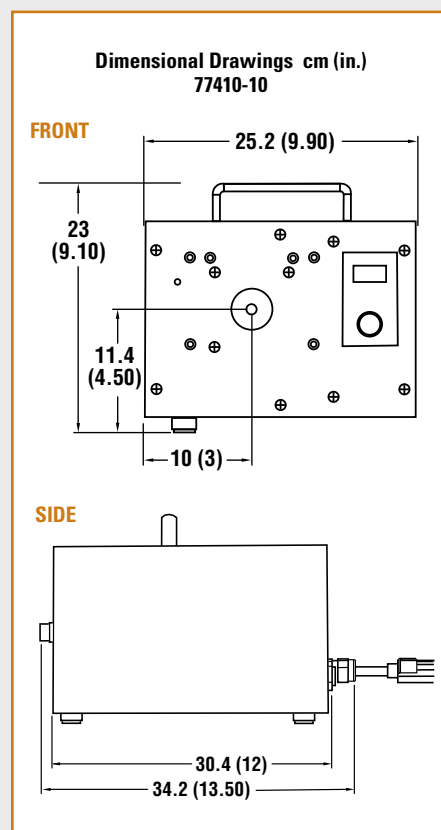

**Stack up to two I/P Standard pump heads (below, left)  
or two I/P Easy-Load pump heads (below, right)  
with any I/P tubing formulation.**



### FOR THE LATEST...

**Masterflex technical resources, see**

- [ColeParmer.com](http://ColeParmer.com)
- [Masterflex.com](http://Masterflex.com)

### 24-HOUR PROTECTION

The Liqui-Sense® emergency cut-off system protects you from pumping problems 24 hours a day. Detection of a leak or an unusual liquid level in a tank signals the Liqui-Sense controller to turn off your pump and turn on a backup. Please see pages 160–161 for a complete description.



I/P\* PUMP HEADS ..... **118–125**  
I/P\* TUBING ..... **126–130**  
I/P\* PUMP SYSTEMS ..... **146–151**

ACCESSORIES ..... **160–171**

TECHNICAL DATA ..... **172–206**

## I/P® BRUSHLESS PROCESS DRIVE WITH REMOTE I/O

### FEATURES/BENEFITS

- ▶ 1/3-hp brushless motor handles challenging applications with minimal maintenance
- ▶ Nonchip epoxy-coated, IP55-rated steel enclosure protects against moisture, chemicals, and dust
- ▶ 1% speed resolution
- ▶ Remote inputs include 4 to 20 mA, 0 to 10 V, start/stop, and reverse
- ▶ Remote outputs include “pump ready” signal and 4 to 20 mA
- ▶ Compact drive is light enough to carry with one hand, but powerful enough to drive two pump heads
- ▶ Easy-to-read LED display
- ▶ Convenient carrying handle allows for easy portability
- ▶ Reversible motor—pump in either direction
- ▶ Control speed via a three-turn potentiometer for quick, easy adjustments
- ▶ Start/stop, change pump direction, or switch between local and remote control using the sealed keypad
- ▶ Motor speed is displayed from 5 to 100% via a digital display
- ▶ Control pump with handheld remote or wash-down foot switch

### DRIVE/SPEED CONTROLS

- ▶ Protected power switch located on back of drive
- ▶ Lighted display indicates power is on
- ▶ Control the speed and direction of the flow via the following:
  - ◆ STOP/START
  - ◆ DIRection
  - ◆ SPEED
  - ◆ INT/EXT, INT for internal control; EXT from remote current or voltage control

### NOTES

This brushless process drive supplies enough torque to drive two pump heads using any I/P tubing formulation.



I/P brushless process drive 77411-00 with remote input/output control shown with I/P High-performance pump head 77600-62

### SETUP

1. Mount pump head(s) and load tubing.
2. Attach any external control connections.
3. Turn drive power on.
4. Select INTERNAL or EXTERNAL operation.
5. Select pump DIRECTION (clockwise or counter-clockwise).
6. Press STOP/START key to begin pumping.
7. Adjust speed to achieve desired flow rate.

### SPEED CONTROL/CIRCUITRY

- ▶ Regulate motor speed from 5 to 100% via the analog button (clockwise rotation increases speed), 4 to 20 mA, or 0 to 10 V signal
- ▶ Soft start for starts without power surges
- ▶ Speed not affected by variations in line voltage (VAC) or frequency (Hz)
- ▶ Line filters reduce outside interference
- ▶ Meets UL 508C, CSA C22.2, No. 14, EN61010-1 and EN61326-1 (for CE mark)

### REMOTE CONTROL

- ▶ Speed control input: 4 to 20 mA and 0 to 10 V (scaleable)
- ▶ Internal and External START/STOP; External CW/CCW via contact closure
- ▶ Tach output: 4 to 20 mA
- ▶ ±0.5% linearity control
- ▶ ±50 V common mode range
- ▶ 18-pin circular waterproof connection
- ▶ Operate pump via a washdown foot switch; order separately under “Accessories” on page 135

### PUMP HEADS ACCEPTED

- ▶ Accepts three different pump head types: Standard, Easy-Load®, or High-Performance

ISO9001:2008  
CERTIFIED SUPPLIER



2 year  
warranty

### ORDERING INFORMATION

Catalog number	rpm	Power (50/60 Hz)
<a href="#">HL-77411-00</a>	33 to 650	90 to 260 VAC

### I/P PUMP TUBING

### FLOW RATE INFORMATION

Order Masterflex I/P pump tubing separately on pages 126–130.

STANDARD  
0.40 to 13 LPM  
pages 120–121



EASY-LOAD®  
0.20 to 13 LPM  
pages 122–123



HIGH-PERFORMANCE  
0.40 to 19 LPM  
pages 124–125



Tubing cross sections	I/P Precision pump tubing			I/P High-performance Precision pump tubing <sup>1</sup>		
	I/P 26	I/P 73	I/P 82	I/P 70	I/P 88	I/P 89
Flow range @ 33 to 650 rpm	0.20 to 4.0 LPM (0.06 to 1.0 GPM)	0.40 to 8.0 LPM (0.11 to 2.1 GPM)	0.66 to 13 LPM (0.17 to 3.5 GPM)	0.40 to 8.0 LPM (0.11 to 2.1 GPM)	0.66 to 17 LPM (0.17 to 4.5 GPM)	0.86 to 19 LPM (0.23 to 5.0 GPM)

<sup>1</sup>Use High-performance Precision tubing with High-Performance pump head only. Flow rates were determined using water at room temperature and with zero back pressure and suction lift.



### SPECIFICATIONS for I/P Analog Brushless Process Drive with Remote I/O

Catalog number		<a href="#">HL-77411-00</a>
<b>Performance Specifications</b>		
Flow capacity		0.2 to 19 LPM (0.06 to 5.0 GPM)
rpm		33 to 650
Number of heads accepted		2
Maximum torque	Starting	678 N-cm (960 oz-in)
	Running	382 N-cm (540 oz-in)
Reversible		Yes
External control	Input	4 to 20 mA, 0 to 10 V; Start/Stop, CW/CCW
	Output	4 to 20 mA; pump ready output; NO and NC contact closures
<b>Electrical Specifications</b>		
Voltage/Frequency VAC (50/60 Hz)		90 to 130 and 220 to 260, dual-voltage autoselecting
Current		4.5 A at 115 VAC; 2.6 A at 230 VAC
Fuse rating		6.3 A / 250 V
Motor type		Continuous-duty, brushless DC
Motor size		0.25 kW (1/3 hp)
Display		Three-digit, seven-segment LED
Motor/speed control type		Three-turn potentiometer
Speed regulation (repeatability)		±0.25%
Soft start/Electronic brake		Yes/Yes
<b>Physical Specifications</b>		
Housing materials		Painted steel
IP rating <sup>†</sup>		IP55
Agency listings		UL, cUL, CE
Operating temperature		0 to 40°C (32 to 104°F)
Storage temperature		-25 to 65°C (-13 to 149°F)
Dimensions (L x W x H)		35 x 25 x 23 cm (14" x 10" x 9")
Shipping weight		10 kg (22 lb)

<sup>†</sup>See page 194 for an explanation of IP ratings.

### ACCESSORIES

[HL-77300-32](#) Remote cable kit; wire to controller/PLC; 8.3-m (25-ft) length.

[HL-07595-43](#) Washdown foot switch, momentary start/stop; 1.8-m (6-ft) cable.

[HL-17050-01](#) NIST-traceable calibration for peristaltic pump drive.



Foot switch  
07595-43

Stack up to two I/P Standard pump heads (below, left)  
or two I/P Easy-Load pump heads (below, right)  
with any I/P tubing formulation.

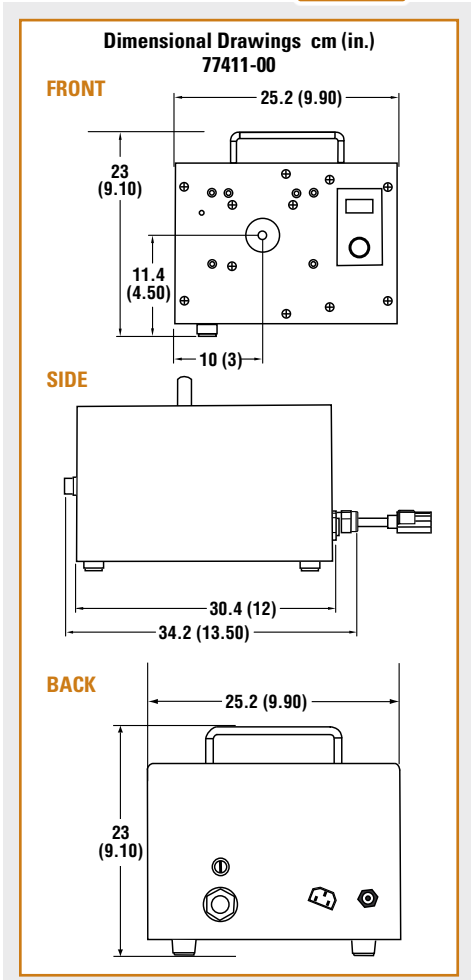

I/P\* PUMP HEADS ..... 118-125

I/P\* TUBING ..... 126-130

I/P\* PUMP SYSTEMS ..... 146-151

ACCESSORIES ..... 160-171

TECHNICAL DATA ..... 172-206

## I/P® DIGITAL MODULAR DISPENSING DRIVES

### FEATURES/BENEFITS

- ▶ Flow rates: 0.0006 to 19 LPM (0.0002 to 5.0 GPM) with I/P tubing; up to 26 LPM (7 GPM) with two Easy-Load® or Standard pump heads
- ▶ Separate drive and controller for convenient placement; a 1.8-m (6-ft) control cable is included. Extend that distance with optional 2.7-m (9-ft) extension cable
- ▶ Four-line graphical LCD shows four operating modes: continuous run, volume dispense, time dispense, and copy dispense
- ▶ Select one of seven languages for programming and operation
- ▶ Set time interval (delay) between dispense cycles for hands-free dispensing
- ▶ Antidrip function ensures dispensing accuracy
- ▶ Batch count lets you set the desired number of batches and displays number of batches completed
- ▶ User-selectable English or metric flow/volume units
- ▶ PWM speed control with tachometer feedback for ±0.1% speed control accuracy
- ▶ Reversible, maintenance-free brushless motor
- ▶ Universal voltage, 90 to 260 VAC autoselect, 50/60 Hz
- ▶ Compatible with all I/P pump heads

### DRIVE CONTROLS

- ▶ Protected power switch located on controller
- ▶ Lighted display indicates power is on
- ▶ Simple programming and operation of the following via sealed membrane keypad:
  - ◆ Speed control: 0 to 20 mA, 4 to 20 mA, or 0 to 10 V
  - ◆ Tubing size
  - ◆ Flow rate
  - ◆ Flow direction
  - ◆ Flow units (English or metric)
  - ◆ Motor speed (rpm)
  - ◆ Total volume
  - ◆ Dispense (volume/copy/time)
  - ◆ Batch count
  - ◆ On/off time
  - ◆ Antidrip
  - ◆ Control mode (remote/internal)
  - ◆ Prime
  - ◆ Start/stop
  - ◆ Calibration



Digital modular drive 07594-00 includes a benchtop controller (drive not shown)

### SETUP

1. Mount pump head(s) and load tubing.
2. Turn drive power on and select language.
3. Select manual (internal) or remote control.
4. Select motor direction.
5. Prime and calibrate pump if required.
6. Set flow rate through keypad.
7. Press START key to begin pumping.

### SPEED CONTROL/CIRCUITRY

- ▶ Regulate motor through keypad and menus, 4 to 20 mA, or 0 to 10 V signal
- ▶ Soft start for starts without power surges
- ▶ Speed not affected by variations in power line voltage (VAC) or frequency (Hz)
- ▶ Line filters reduce outside interference
- ▶ Meets UL 61010-1, CSA C22.2, No. 61010-1; For CE mark: EN61010-1 (EU low voltage) and EN61326-1 (EU EMC)

### SELECTION CRITERIA

1. Motor rpm / flow rate.
  2. Benchtop or washdown, wall-mount controller.
- Order pump heads and tubing separately.

**NEW**

Digital modular drive 07594-10 includes a wall-mount controller; shown with I/P Easy-Load pump head 77601-10



### CALIBRATION

1. Select TUBING CAL through Main or Setup menu.
2. Set flow direction, tubing size, and flow rate.
3. Prime the tubing.
4. Highlight START and press ENTER, drive will run based on default volume.
5. Press ENTER and adjust CAL VOLUME to the actual measured volume.
6. Press ENTER to SAVE setting and EXIT.

Note: Digital signal processor retains one calibration value for each tubing size, even when power is turned off.

ISO9001:2008  
CERTIFIED SUPPLIER



2 year  
warranty

### ORDERING INFORMATION

Catalog number	rpm	Power (50/60 Hz)
<b>Benchtop digital modular drive</b>		
<a href="#">HL-07594-00</a>	0.1 to 650	90 to 260 VAC
<b>Digital modular drive with washdown controller</b>		
<a href="#">HL-07594-10</a>	0.1 to 650	90 to 260 VAC

### I/P PUMP TUBING FLOW RATE INFORMATION

Order Masterflex I/P tubing on pages 126–130.

STANDARD  
0.001 to 13 LPM  
pages 120–121



EASY-LOAD®  
0.001 to 13 LPM  
pages 122–123



HIGH-PERFORMANCE  
0.001 to 19 LPM  
pages 124–125



Tubing cross sections	I/P Precision pump tubing sizes			I/P High-performance Precision pump tubing sizes†		
	I/P 26	I/P 73	I/P 82	I/P 70	I/P 88	I/P 89
Flow range @ 0.1 to 650 rpm	0.001 to 4 LPM (0.0002 to 1.0 GPM)	0.001 to 8 LPM (0.0002 to 2.1 GPM)	0.002 to 13 LPM (0.0005 to 3.5 GPM)	0.001 to 8 LPM (0.0002 to 2.1 GPM)	0.002 to 17 LPM (0.0005 to 4.5 GPM)	0.002 to 19 LPM (0.0005 to 5.0 GPM)

†Use with High-Performance pump head only.



## SPECIFICATIONS for I/P Digital Modular Dispensing Drives

Catalog number	<a href="#">HL-07594-00</a>	<a href="#">HL-07594-10</a>
<b>Performance Specifications</b>		
Flow capacity	0.0006 to 19 LPM (0.0002 to 5 GPM)	
rpm	0.1 to 650	
Number of heads accepted	2	
Maximum torque	Starting	1102 N·cm (1560 oz-in)
	Running	367 N·cm (520 oz-in)
Reversible	Yes	
External control – Input	0 to 20 mA, 4 to 20 mA, 0 to 10 V; START/STOP, CW/CCW, PRIME via contact closure	
External control – Output	1 to 20 mA, 4 to 20 mA, 0 to 10 V; TTL pulse, drive running	
<b>Electrical Specifications</b>		
Voltage/Frequency VAC (Hz)	90 to 260 (50/60)	
Current	4.5 A at 115 V; 2.6 A at 230 V	
Fuse rating	6.3 A / 250 V	
Motor type	Continuous duty, brushless DC	
Motor size	280 W (% hp)	
Display	Four-line graphical LCD	
Motor/speed control type	PWM with microprocessor	
Speed regulation	±0.1%	
Soft start/Electronic brake	Yes/Yes	
<b>Physical Specifications</b>		
Housing materials	Drive	Painted steel and aluminum
	Controller	Painted steel and aluminum
IP rating†	Drive	IP33
	Controller	IP66 (NEMA 4X)
Agency listings	ETL, cETL, CE	
Operating temperature	0 to 40°C (32 to 104°F)	
Storage temperature	–25 to 65°C (–13 to 149°F)	
Dimensions (L x W x H)	Drive	36.2 x 17.8 x 16.5 cm (14¼" x 7" x 6½")
	Controller	26.3 x 21.1 x 14.0 cm (10¾" x 8¾" x 5½")
Shipping weight	12.6 kg (27.8 lb)	14.1 kg (30.8 lb)

†See page 194 for an explanation of IP ratings.

## REMOTE CONTROL

### Benchtop Modular Drive

- ▶ Remote control via 25-pin (DB25) female connection on back of controller
- ▶ Speed control input: 0 to 20 mA, 4 to 20 mA, and 0 to 10 V (scaleable/invertable)
- ▶ Speed signal output: 0 to 20 mA, 4 to 20 mA, and 0 to 10 V (scaleable/invertable)
- ▶ START/STOP, CW/CCW, PRIME via contact closure
- ▶ Tach output: open collector
- ▶ Motor running indicator
- ▶ Remote cable and foot switch options; order separately under "Accessories"

### Modular Drive with Washdown, Wall-Mount Controller

- ▶ Remote control via 31-pin weather-resistant circular connection on bottom of controller
- ▶ Speed control input: 0 to 20 mA, 4 to 20 mA, and 0 to 10 V (scaleable/invertable)
- ▶ Speed signal output: 0 to 20 mA, 4 to 20 mA, and 0 to 10 V (scaleable/invertable)
- ▶ START/STOP, CW/CCW, PRIME via contact closure
- ▶ Tach output: open collector
- ▶ Motor running indicator
- ▶ Remote cable and foot switch options; order separately under "Accessories"

## KEYPAD LOCK/UNLOCK FEATURE

- ▶ Lock keypad and protect settings by highlighting the lock icon and pressing ENTER
- ▶ Select LOCK and press ENTER to exit menu
- ▶ Repeat above steps to unlock keypad

## ACCESSORIES

### For Benchtop Model 07594-00

[HL-77301-82](#) Extension cable, 2.7 m (9 ft), to extend distance between motor and controller.

[HL-07523-92](#) Foot switch, momentary start/stop; 1.8-m (6-ft) cable.

[HL-07523-95](#) Remote control cable assembly, DB25 male connector and 7.9-m (25-ft) cable with stripped wire ends for remote control.

[HL-17050-01](#) NIST-traceable calibration with data for peristaltic pump drive.

### For Washdown Model 07594-10

[HL-77301-82](#) Extension cable, 2.7 m (9 ft), to extend distance between motor and controller.

[HL-07575-84](#) Washdown foot switch, momentary start/stop; 1.8-m (6-ft) cable.

[HL-07575-80](#) Remote control cable assembly; 31-pin round water-tight connector and 7.9-m (25-ft) cable with stripped wire ends for remote control, wire to controller/PLC.

[HL-17050-01](#) NIST-traceable calibration with data for peristaltic pump drive.

## Dimensional Drawings cm (in.)

### 07594-00 Controller

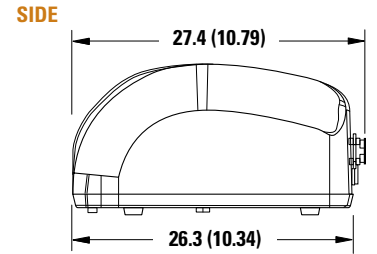
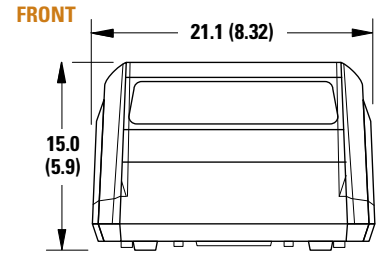

### 07594-10 Controller

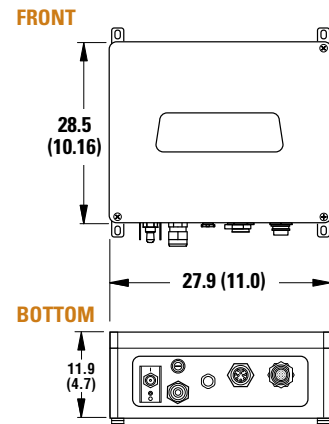

### 07594-Series Drive

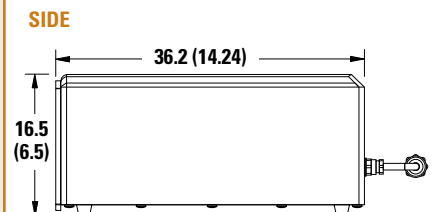
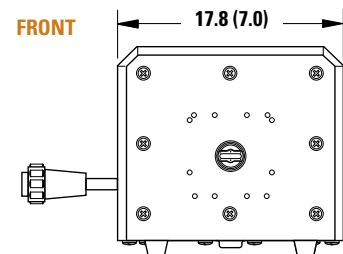

## I/P® DIGITAL PROCESS DRIVES

### FEATURES/BENEFITS

- ▶ Flow rates: 0.0006 to 19 LPM (0.0002 to 5.0 GPM) with I/P tubing; achieve up to 26 LPM (7 GPM) with two stacked Easy-Load® or Standard pump heads
- ▶ Four-line graphical LCD shows four operating modes: continuous run, volume dispense, time dispense, and copy dispense—interface permits precise setting of desired flow rate or volume without over- or undershoot
- ▶ Select one of seven languages for programming and operation
- ▶ Set time interval (delay) between dispense cycles for hands-free dispensing
- ▶ Antidrip function ensures dispensing accuracy
- ▶ Batch count lets you set the desired number of batches and displays number of batches completed
- ▶ Cumulative volume function (totalizer) tracks total volume dispensed/pumped
- ▶ User-selectable English or metric flow/volume units
- ▶ PWM speed control with tachometer feedback for ±0.1% speed control accuracy
- ▶ Reversible, maintenance-free brushless motor
- ▶ Universal voltage, 90 to 260 VAC autoselect, 50/60 Hz
- ▶ Compatible with all I/P pump heads

### DRIVE CONTROLS

- ▶ Protected power switch located on back of drive
- ▶ Lighted display indicates power is on
- ▶ Simple programming and operation of the following via sealed membrane keypad:
  - ◆ Tubing size
  - ◆ Flow rate
  - ◆ Flow direction
  - ◆ Flow units (English or metric)
  - ◆ Motor speed (rpm)
  - ◆ Total volume
  - ◆ Dispense (volume/copy/time)
  - ◆ Batch count
  - ◆ On/off time
  - ◆ Antidrip
  - ◆ Control mode (remote/internal)
  - ◆ Prime
  - ◆ Start/stop
  - ◆ Calibration

### SETUP

1. Mount pump head(s) and load tubing.
2. Turn drive power on and select language.
3. Select manual (internal) or remote control.
4. Select motor direction.
5. Prime and calibrate pump if required.
6. Set flow rate through keypad.
7. Press START key to begin pumping.

### SPEED CONTROL/ CIRCUITRY

- ▶ Regulate motor through keypad and menus, 4 to 20 mA, or 0 to 10 V signal
- ▶ Soft start for starts without power surges
- ▶ Speed not affected by variations in power line voltage (VAC) and frequency (Hz)
- ▶ Line filters reduce outside interference
- ▶ Meets UL 61010-1, CSA C22.2, No. 61010-1; For CE mark: EN61010-1 (EU low voltage) and EN61326-1 (EU EMC)

### REMOTE CONTROL

- ▶ Remote control via 31-pin weather-resistant circular connection on back of drive
- ▶ Speed control input: 0 to 20 mA, 4 to 20 mA, and 0 to 10 V (scaleable/invertable)
- ▶ Speed signal output: 0 to 20 mA, 4 to 20 mA, and 0 to 10 V (scaleable/invertable)
- ▶ START/STOP, CW/CCW, PRIME via contact closure
- ▶ Tach output: open collector
- ▶ Motor running indicator
- ▶ Remote cable and foot switch options; order separately under "Accessories"

**NEW**

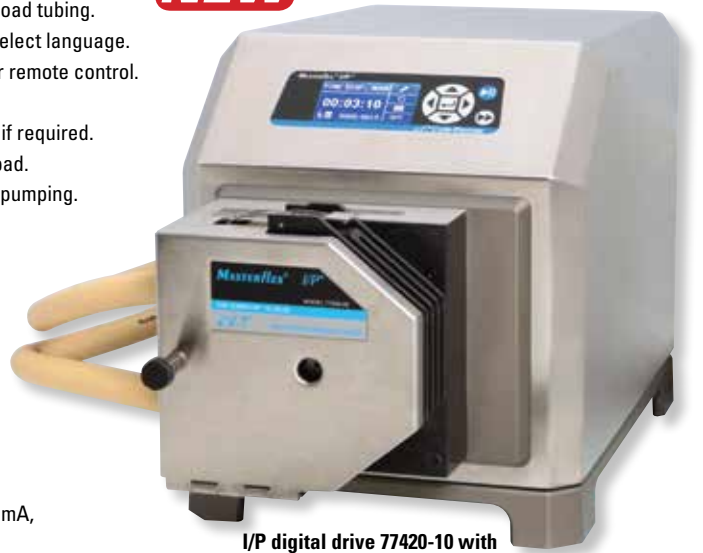

I/P digital drive 77420-10 with I/P High-performance pump head 77600-62

### SELECTION CRITERIA

1. Motor rpm / flow rate.
2. Housing material: 316 stainless steel or powder-coat steel.

Order pump heads and tubing separately.

ISO9001:2008  
CERTIFIED SUPPLIER



2 year warranty

### ORDERING INFORMATION

Catalog number	rpm	Power (50/60 Hz)
<b>Digital process drive with 316 stainless steel housing</b>		
<a href="#">HL-77420-10</a>	0.1 to 650	90 to 260 VAC
<b>Digital process drive with powder-coat steel housing</b>		
<a href="#">HL-77420-20</a>	0.1 to 650	90 to 260 VAC

### I/P PUMP TUBING FLOW RATE INFORMATION

Order Masterflex I/P pump tubing separately on pages 126–130.

STANDARD  
0.001 to 13 LPM  
pages 120–121



EASY-LOAD®  
0.001 to 13 LPM  
pages 122–123



HIGH-PERFORMANCE  
0.001 to 19 LPM  
pages 124–125



Tubing cross sections	I/P Precision pump tubing			I/P High-performance Precision pump tubing†		
	I/P 26	I/P 73	I/P 82	I/P 70	I/P 88	I/P 89
Flow range @ 0.1 to 650 rpm	0.001 to 4.0 LPM (0.0002 to 1.0 GPM)	0.001 to 8.0 LPM (0.0002 to 2.1 GPM)	0.002 to 13 LPM (0.0005 to 3.5 GPM)	0.001 to 8.0 LPM (0.0002 to 2.1 GPM)	0.002 to 17 LPM (0.0005 to 4.5 GPM)	0.002 to 19 LPM (0.0005 to 5.0 GPM)

†Use High-performance Precision tubing with High-Performance pump head. Flow rates were determined using water at room temperature and with zero back pressure and zero suction lift.



### SPECIFICATIONS for I/P Digital Process Drives

Catalog number	<a href="#">HL-77420-10</a>	<a href="#">HL-77420-20</a>
<b>Performance Specifications</b>		
Flow capacity	0.0006 to 19 LPM (0.0002 to 5 GPM)	
rpm	0.1 to 650	
Number of heads accepted	2	
Maximum torque	Starting	1102 N-cm (1560 oz-in)
	Running	367 N-cm (520 oz-in)
Reversible	Yes	
External control – Input	0 to 20 mA, 4 to 20 mA, 0 to 10 V; START/STOP, CW/CCW, PRIME via contact closure	
External control – Output	1 to 20 mA, 4 to 20 mA, 0 to 10 V; TTL pulse, drive running	
<b>Electrical Specifications</b>		
Voltage/Frequency VAC (Hz)	90 to 260 (50/60)	
Current	4.5 A at 115 V; 2.5 A at 230 V	
Fuse rating	6.3 A / 250 V	
Motor type	Continuous duty, brushless DC	
Motor size	280 W (¾ hp)	
Display	Four-line graphical LCD	
Motor/speed control type	PWM with microprocessor	
Speed regulation	±0.1%	
Soft start/Electronic brake	Yes/Yes	
<b>Physical specifications</b>		
Housing materials	316 stainless steel	Epoxy powder-coat steel
IP rating†	IP66 (NEMA 4X)	
Agency listings	ETL, cETL, CE	
Operating temperature	0 to 40°C (32 to 104°F)	
Storage temperature	-25 to 65°C (-13 to 149°F)	
Dimensions (L x W x H)	42.3 x 28.3 x 32.8 cm (16¾" x 11½" x 13")	
Shipping weight	18.1 kg (40 lb)	

†See page 194 for an explanation of IP ratings.

### CALIBRATION

1. Select TUBING CAL via Main or Setup menu.
2. Set flow direction, tubing size, and flow rate.
3. Prime the tubing.
4. Highlight START and press ENTER, drive will run based on default volume.
5. Press ENTER and adjust CAL VOLUME to the actual measured volume.
6. Press ENTER to SAVE setting and EXIT.

**Note:** Digital signal processor retains one calibration value for each tubing size, even when power is turned off.

### KEYPAD LOCK/UNLOCK FEATURE

- ▶ Lock keypad and protect settings by highlighting the lock icon and pressing ENTER
- ▶ Select LOCK and press ENTER to exit menu
- ▶ Repeat above steps to unlock keypad

### ACCESSORIES

[HL-07575-84](#) Washdown foot switch, momentary start/stop; 1.8-m (6-ft) cable.

[HL-07575-80](#) Remote control cable assembly; 31-pin round water tight connector and 7.9-m (25-ft) cable with stripped wire ends for remote control, wire to controller/PLC.

[HL-17050-01](#) NIST-traceable calibration with data for peristaltic pump drive.

The I/P digital console process drive accepts a single I/P High-performance pump head or up to two I/P Standard pump heads (below, left) or two I/P Easy-Load pump heads (below, right) with any I/P tubing formulation.

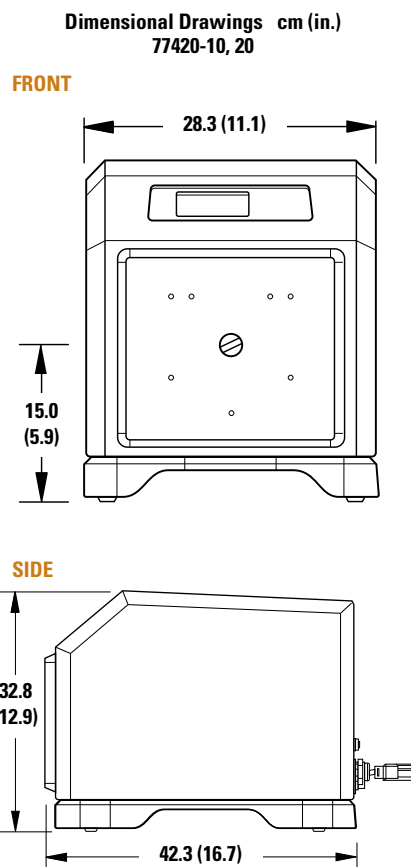

I/P digital drive 77420-20 with Easy-Load® pump head 77601-10

I/P PUMP HEADS ..... 118–125  
I/P TUBING ..... 126–130  
I/P PUMP SYSTEMS ..... 146–151

ACCESSORIES ..... 160–171

TECHNICAL DATA ..... 172–206

## I/P® VARIABLE-SPEED AIR-POWERED DRIVE

### FEATURES/BENEFITS

- ▶ Deliver flow rates from 0.6 to 17 LPM
- ▶ Ideal for locations where electrical power may be unsafe or impractical
  - ◆ Intrinsically safe when properly grounded for static electricity
  - ◆ No electric power required
- ▶ Wide flow control range (6.5:1 turndown)
- ▶ Compact, portable console package
- ▶ ATEX Zone 2 rated to EEx II 3 G c II C T6; NEC Class I, Division 2, Groups A, B, C, D, T6

### SETUP

1. Install the 0 to 100 psi pressure gauge, pressure regulator with 5-µm filter, automatic lubricator, and muffler (all items included).
2. Connect compressed air line to 1/4" NPT(F) connection on regulator.
3. Mount I/P pump head; load I/P tubing.
4. Turn on compressed air line.

**Air hose and compressor are not included.**

### SPEED CONTROL/CIRCUITRY

- ▶ Adjust using pressure regulator knob

### PUMP HEADS ACCEPTED

- ▶ Drive accepts I/P Standard, Easy-Load®, and High-Performance pump heads



**I/P variable-speed air-powered drive 07589-30 shown with I/P Easy-Load® pump head 77601-80**

### SPECIFICATIONS for I/P Variable-Speed Air-Powered Drive

Catalog number	<a href="#">HL-07589-30</a>	
<b>Performance Specifications</b>		
Flow capacity	0.6 to 19 LPM (0.2 to 5.0 GPM)	
rpm	100 to 650	
Number of heads accepted	2	
Maximum torque	Starting	1080 N-cm (1080 oz-in)
	Running	254 N-cm (360 oz-in)
<b>Electrical Specifications</b>		
Motor type	Rotary vane air motor	
Motor size	560 W (¾ hp)	
Speed regulation (repeatability)	±10%	
<b>Physical Specifications</b>		
Housing material	Painted steel	
IP rating†	IP34	
Agency listings	CE	
Operating temperature	0 to 40°C (32 to 104°F)	
Storage temperature	-25 to 65°C (-13 to 149°F)	
Dimensions (L x W x H)	28.2 x 21.6 x 22.9 cm (11½" x 8½" x 9")	
Shipping weight	9.6 kg (21 lb)	

†See page 194 for an explanation of IP ratings.

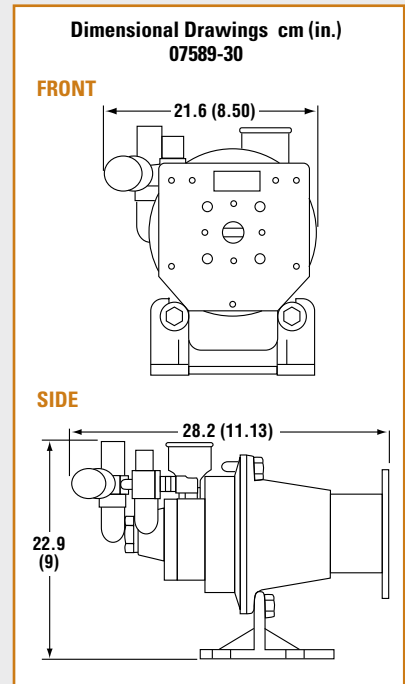

### ORDERING INFORMATION

Catalog number	rpm	Power
<a href="#">HL-07589-30</a>	100 to 650	0.08 to 0.7 m³/min (3 to 25 cfm) @ 1.4 to 6.9 bar (20 to 100 psi)

### I/P PUMP TUBING

#### FLOW RATE INFORMATION

Order Masterflex I/P tubing on pages 126–130.

**STANDARD**  
1.2 to 13 LPM  
pages 120–121



**EASY-LOAD®**  
0.6 to 13 LPM  
pages 122–123



**HIGH-PERFORMANCE**  
1.2 to 19 LPM  
pages 124–125



Tubing cross sections	I/P Precision pump tubing sizes			I/P High-performance Precision pump tubing sizes†		
Flow range @ 100 to 650 rpm	0.6 to 4 LPM (0.2 to 1.1 GPM)	1.2 to 8 LPM (0.3 to 2.1 GPM)	2 to 13 LPM (0.5 to 3.5 GPM)	1.2 to 8 LPM (0.3 to 2.1 GPM)	2.5 to 17 LPM (0.5 to 4.5 GPM)	2.6 to 19 LPM (0.7 to 5.0 GPM)

†Use high-performance Precision tubing with High-Performance pump head only.





# I/P<sup>®</sup> FIXED-SPEED DRIVES

## FEATURES/BENEFITS

- ▶ Flow rates: 0.5 to 14 LPM (0.1 to 3.6 GPM) depending on drive model, pump head, and tubing size selected
- ▶ IP55 rated for excellent protection from dust and water in harsh process or manufacturing environments
- ▶ Easy to clean—just hose down after use
- ▶ Combination CW/OFF/CCW switch; purge before or after pumping, pump in either direction
- ▶ Accept I/P Standard, Easy-Load<sup>®</sup>, or High-Performance pump heads for wide flow range; stack two Standard or Easy-Load heads to double flow
- ▶ Easily configure for up to four channels of flow with multichannel pump systems (see page 150)

## DRIVE CONTROLS

- ▶ Protected fused power switch located on side of drive

## SETUP

1. Mount pump head(s) and load tubing.
2. Select CW or CCW motor direction.
3. Switch pump on.

## SPEED CONTROL/CIRCUITRY

- ▶ Fixed-speed drives; direction of rotation control only
- ▶ Meets UL 778, CSA C22.2 No. 108-01, EN61010-1 (for CE mark)



## ORDERING INFORMATION

Catalog number	rpm	Power
<a href="#">HL-07588-60</a>	100	115 VAC, 60 Hz
<a href="#">HL-07588-65</a>	83	230 VAC, 50 Hz
<a href="#">HL-07588-30</a>	540	115 VAC, 60 Hz
<a href="#">HL-07588-35</a>	450	230 VAC, 50 Hz

## ACCESSORIES

[HL-17050-01](#) NIST-traceable calibration for peristaltic pump drive.



**I/P fixed-speed drive 07588-60 shown with I/P High-Performance pump head 77600-62**

## SPECIFICATIONS for I/P Fixed-Speed Drives

Catalog number	<a href="#">HL-07588-60</a>	<a href="#">HL-07588-65</a>	<a href="#">HL-07588-30</a>	<a href="#">HL-07588-35</a>
<b>Performance Specifications</b>				
Flow capacity, depending on tubing size	0.6 to 2.6 LPM (0.2 to 0.7 GPM)	0.5 to 2.2 LPM (0.1 to 0.6 GPM)	3.3 to 14.1 LPM (0.8 to 3.6 GPM)	2.8 to 11.8 LPM (0.7 to 3.0 GPM)
rpm	100	83	540	450
Number of heads accepted	2		2	
Maximum torque	Starting	922 N-cm (1306 oz-in)		723 N-cm (1024 oz-in)
	Running	836 N-cm (1184 oz-in)		633 N-cm (896 oz-in)
Reversible	Yes			
<b>Electrical Specifications</b>				
Voltage/Frequency VAC (Hz)	90 to 130 (60)	190 to 260 (50)	90 to 130 (60)	190 to 260 (50)
Current	8 A at 115 VAC	4 A at 230 VAC	8 A at 115 VAC	4 A at 230 VAC
Motor type	Continuous-duty, TEFC, brushless AC (induction)			
Motor size	0.37 kW (½ hp)			
Motor/speed control type	Fixed speed			
<b>Physical Specifications</b>				
Housing materials	Painted steel			
IP rating†	IP55			
Agency listings	UL, CSA	CE	UL, CSA	CE
Operating temperature	0 to 40°C (32 to 104°F)			
Storage temperature	-25 to 65°C (-13 to 149°F)			
Dimensions (L x W x H)	43 x 26.7 x 26.1 cm (17" x 11" x 10¼")			
Shipping weight	19 kg (42 lb)			

†See page 194 for an explanation of IP ratings.

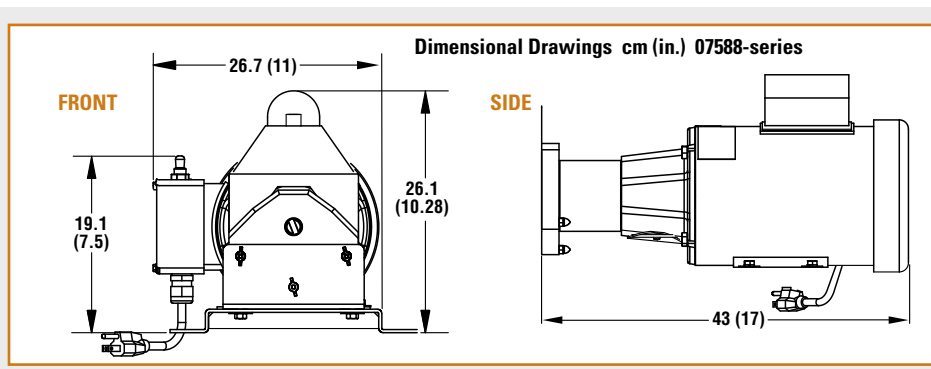

## I/P PUMP TUBING FLOW RATE INFORMATION

Order Masterflex I/P tubing on pages 126–130.

	I/P Precision pump tubing			I/P High-performance Precision pump tubing		
	I/P 26	I/P 73	I/P 82	I/P 70	I/P 88	I/P 89
Flow rate @ 83 rpm	0.5 LPM (0.1 GPM)	1.0 LPM (0.3 GPM)	1.7 LPM (0.5 GPM)	1.0 LPM (0.3 GPM)	1.7 LPM (0.5 GPM)	2.2 LPM (0.6 GPM)
Flow rate @ 100 rpm	0.6 LPM (0.2 GPM)	1.3 LPM (0.3 GPM)	2.0 LPM (0.5 GPM)	1.3 LPM (0.3 GPM)	2.0 LPM (0.5 GPM)	2.6 LPM (0.7 GPM)
Flow rate @ 450 rpm	2.6 LPM (0.7 GPM)	5.7 LPM (1.5 GPM)	9.2 LPM (2.4 GPM)	5.7 LPM (1.5 GPM)	9.2 LPM (2.4 GPM)	11.8 LPM (3.0 GPM)
Flow rate @ 540 rpm	3.2 LPM (0.8 GPM)	6.8 LPM (1.8 GPM)	11.0 LPM (2.9 GPM)	6.8 LPM (1.8 GPM)	11.0 LPM (2.9 GPM)	14.1 LPM (3.6 GPM)

## I/P® VARIABLE-SPEED HAZARDOUS-DUTY DRIVE

### FEATURES/BENEFITS

- ▶ Flow rates from 0.06 to 11.5 LPM\* (0.6 to 2500 mL/min using L/S® pump heads)
- ▶ 115 VAC motor: UL-listed for Class 1, Groups C and D, Division 1 hazardous locations
- ▶ Ideal for areas that require special electrical precautions

### SETUP

1. Mount L/S or I/P pump head to mounting plate.
2. Load Masterflex L/S or I/P tubing.
3. Turn pump on.

**Power switch and line cord are not included.**

### SPEED CONTROL/CIRCUITRY

- ▶ Mechanical speed control (zero-max) with lever
- ▶ Locking knob to maintain speed control

### PUMP HEADS ACCEPTED

- ▶ Drive accepts 11 different pump heads:
  - ◆ I/P pump heads: Standard, Easy-Load®, High-Performance
  - ◆ L/S pump heads: Standard, Easy-Load 3, Easy-Load II, Easy-Load, High-Performance, PTFE-Tubing, Multichannel Cartridge, PTFE-Diaphragm
- ▶ For flow rate information using L/S pump heads, see page 102

### ORDERING INFORMATION

Catalog number	rpm	Power
<a href="#">HL-07583-50</a>	10 to 430	115 VAC, 60 Hz



### SPECIFICATIONS for I/P Variable-Speed Hazardous-Duty Drive

Catalog number	<a href="#">HL-07583-50</a>
<b>Performance Specifications</b>	
Flow capacity†	0.06 to 11.5 LPM (0.02 to 3.0 GPM)
rpm	10 to 430
Number of heads accepted	2
Maximum running torque	191 N·cm (270 oz-in)
Reversible	No (CCW from front)
<b>Electrical Specifications</b>	
Voltage/Frequency VAC (Hz)	115 (60)
Current	4.7 A
Motor type	1725 rpm AC
Motor size	190 W (¼ hp)
Motor/speed control type	Mechanical (zero-max) with lever
<b>Physical Specifications</b>	
Housing materials	Painted steel
IP rating‡	IP21
Dimensions (L x W x H)	56.0 x 34.6 x 22.3 cm (22¼" x 13⅝" x 8¾")
Operating temperature	0 to 40°C (32 to 104°F)
Storage temperature	-25 to 65°C (-13 to 149°F)
Shipping weight	26.6 kg (58.6 lb)

†Depending on drive rpm and tubing size. ‡See page 194 for an explanation of IP ratings.

### Dimensional Drawings cm (in.)

#### FRONT

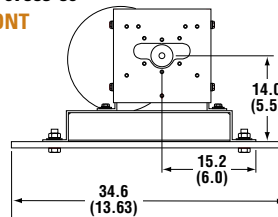

#### SIDE

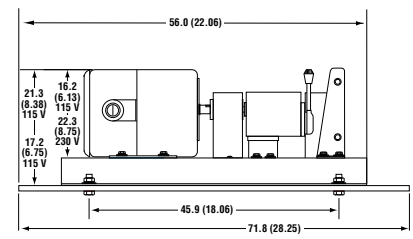

### I/P PUMP TUBING FLOW RATE INFORMATION

Order Masterflex I/P pump tubing on pages 126–130.

**STANDARD**  
0.12 to 8.8 LPM  
pages 120–121



**EASY-LOAD®**  
0.06 to 8.8 LPM  
pages 122–123



**HIGH-PERFORMANCE**  
0.12 to 11.5 LPM  
pages 124–125



Motor rpm range	I/P Precision pump tubing			I/P High-performance Precision pump tubing††		
	I/P 26	I/P 73	I/P 82	I/P 70	I/P 88	I/P 89
10 to 430	0.06 to 2.6 LPM (0.02 to 0.7 GPM)	0.12 to 5.3 LPM (0.03 to 1.4 GPM)	0.20 to 8.8 LPM (0.05 to 2.3 GPM)	0.12 to 5.3 LPM (0.03 to 1.4 GPM)	0.20 to 8.8 LPM (0.05 to 2.3 GPM)	0.26 to 11.5 LPM (0.07 to 3.0 GPM)

††Use with High-Performance pump head only.



## I/P® NEMA TYPE 56C PUMP HEAD ADAPTERS

### FEATURES/BENEFITS

- Deliver flow rates from 0.12 to 17 LPM with Masterflex® I/P pump heads
- Attach your own motor to meet hazardous-duty requirements, washdown necessity, or your unique needs
- Compact, in-line design
- IP34 rated—maintain integrity of your motor rating up to IP34
- Use one or two I/P pump heads; stacking two heads lets you pump two different fluids simultaneously



Adapters include the hardware shown below.



Adapter 77490-00, pump head 77601-00, and motor 02631-02 sold separately

### SELECTION CRITERIA

- Determine flow rate/gear ratio required. (Select a gear ratio to keep pump head rpm from exceeding 650 rpm.)

To calculate nominal flow rate:

$$\frac{\text{motor rpm}}{\text{gear ratio}} \times \text{flow per revolution} = \text{flow rate}$$

### SETUP

- Slide shaft adapter over motor shaft and tighten set screws with hex wrench.
- Position housing over shaft adapter.
- Attach housing to motor with four bolts (supplied).
- Mount pump head and load I/P tubing.
- Turn pump on.

### PUMP HEADS ACCEPTED

- Accepts three Masterflex I/P pump head types: Standard, Easy-Load®, and High-Performance

### MOTOR SPECIFICATIONS

- Order minimum ¼-hp (180-W) motor
- Go to [www.coleparmer.com/motors](http://www.coleparmer.com/motors) for additional motor options and for VFD controllers to vary the speed of the motors listed below right
- Select fixed or variable-speed; TEFC (IP44) washdown (IP56), or hazardous-duty motor; 50, 60, or 50/60 Hz

### SPECIFICATIONS for I/P Pump Head Adapters

Catalog number	<a href="#">HL-77490-00</a> , <a href="#">-10</a> , <a href="#">-20</a> , <a href="#">-30</a>
<b>Performance Specifications</b>	
Number of heads accepted	Up to 2
<b>Physical Specifications</b>	
Construction material	Painted aluminum
IP rating†	IP34 with gasket (included) mounted to motor
Dimensions (L x W x H)	17.2 x 16.5 x 16.5 cm (6¾" x 6½" x 6½")
Operating temperature	0 to 40°C (32 to 104°F)
Storage temperature	-25 to 65°C (-13 to 149°F)
Shipping weight	1.8 kg (4 lb)

†See page 194 for an explanation of IP ratings.



### ORDERING INFORMATION

Catalog number	Gear ratio	Max motor rpm	Max torque kg-cm (oz-in.)
<a href="#">HL-77490-00</a>	3.1:1	2015	35 (480)
<a href="#">HL-77490-10</a>	4.8:1	3120	
<a href="#">HL-77490-20</a>	9.7:1	3600	
<a href="#">HL-77490-30</a>	17.8:1	4800	

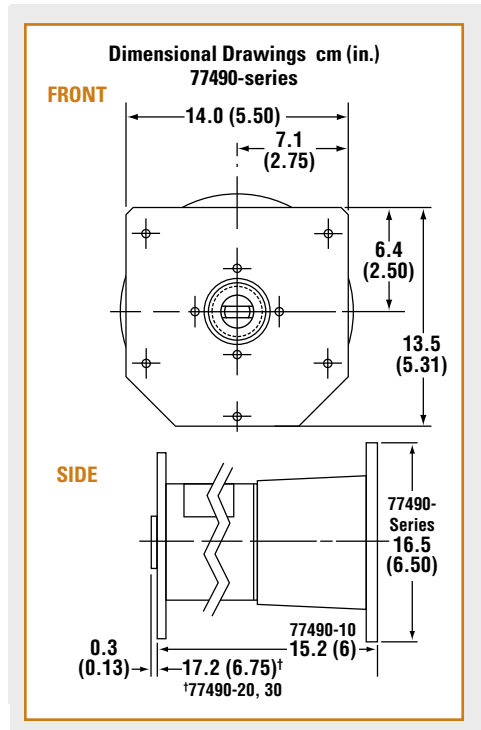

### DC MOTORS WITH 56C FRAME

Cat. no.	hp	Wattage	rpm	Type‡	Voltage	IP rating†	Overall dimensions (L x W x H)
<a href="#">HL-02631-02</a>	½	0.37 kW	1800	TENV	90 VDC	IP44	28.3 x 16.5 x 17.1 cm (11¼" x 6½" x 6¾")
<a href="#">HL-02631-06</a>				XPRF	90 VDC	IP55	31.5 x 16.5 x 17.1 cm (13¾" x 6½" x 6¾")
<a href="#">HL-02631-52</a>				WDN	90 VDC	IP56	31.1 x 16.5 x 17.5 cm (12¼" x 6½" x 6¾")

‡TENV—Totally enclosed, nonventilating TEFC—Totally enclosed, fan-cooled XPRF—Explosion-proof WDN—Washdown †See page 194 for an explanation of IP ratings.

### I/P PUMP TUBING FLOW RATE INFORMATION

Order Masterflex I/P pump tubing separately on pages 126-130.

Recommended motor rpm limits	Adapter gear ratio	Pump head rpm	I/P Precision tubing			I/P High-performance Precision tubing		
			I/P 26	I/P 73	I/P 82	I/P 70	I/P 88	I/P 89
Flow per revolution		1	0.006 (0.002)	0.012 (0.003)	0.020 (0.005)	0.012 (0.003)	0.02 (0.005)	0.026 (0.007)
62 to 2015	3.1:1	20 to 650	0.12 to 4.0 LPM (0.03 to 1.0 GPM)	0.2 to 8 LPM (0.05 to 2.1 GPM)	0.4 to 13 LPM (0.1 to 3.5 GPM)	0.26 to 8 LPM (0.07 to 2.1 GPM)	0.40 to 13 LPM (0.10 to 3.41 GPM)	0.52 to 17 LPM (0.14 to 4.1 GPM)
96 to 3120	4.8:1	20 to 650	0.12 to 4.0 LPM (0.03 to 1.0 GPM)	0.2 to 8 LPM (0.05 to 2.1 GPM)	0.4 to 13 LPM (0.1 to 3.5 GPM)	0.26 to 8 LPM (0.07 to 2.1 GPM)	0.40 to 13 LPM (0.10 to 3.41 GPM)	0.52 to 17 LPM (0.14 to 4.1 GPM)
194 to 3450	9.7:1	20 to 356	0.12 to 2.2 LPM (0.03 to 0.6 GPM)	0.2 to 4.4 LPM (0.05 to 1.2 GPM)	0.4 to 7.0 LPM (0.1 to 1.9 GPM)	0.26 to 4.6 LPM (0.07 to 1.2 GPM)	0.40 to 7.1 LPM (0.10 to 1.9 GPM)	0.52 to 9.3 LPM (0.14 to 2.5 GPM)
356 to 3450	17.8:1	20 to 194	0.12 to 1.2 LPM (0.03 to 0.3 GPM)	0.2 to 2.4 LPM (0.05 to 0.6 GPM)	0.4 to 4.0 LPM (0.1 to 1.1 GPM)	0.26 to 2.5 LPM (0.07 to 0.66 GPM)	0.40 to 3.9 LPM (0.10 to 1.0 GPM)	0.52 to 5.0 LPM (0.14 to 1.3 GPM)

Note: Flow ranges are approximate—calculated under the following conditions: 0 psig at inlet and outlet; water temperature at 22°C (72°F). Flow rates in parentheses obtainable only with High-Performance pump head.

## I/P® MODULAR PUMP

### APPLICATIONS

- ▶ Printing
- ▶ Laboratory research
- ▶ Polishing/lapping
- ▶ Chemical recirculation
- ▶ Sterile fluid transfer
- ▶ Pumping from 55-gallon drums
- ▶ Filtration

### BENEFITS

- ▶ Modular format lets you separate drive and controller for convenient placement; a 1.8-m (6-ft) control cable is included. Extend that distance with optional 2.7-m (9-ft) extension cable
- ▶ Three-digit LED shows motor speed (rpm)—confirm speed setting at a glance
- ▶ Reversible motor—easily reverse direction of flow to purge or prime tubing
- ▶ Remote control via 9-pin (DB9) female connection on back of controller; control speed, direction, start/stop

### FEATURES

- ▶ ½-hp continuous-duty drive
- ▶ ±0.25% drive speed accuracy
- ▶ Motor/controller connected by a 1.8-m (6-ft) cable



77962-20



### SPECIFICATIONS & ORDERING INFORMATION

Catalog number	Flow range <sup>†</sup> (LPM)	Pump head included	Tubing included	Tubing sizes accepted	Drive included	Drive speed range (rpm)	Drive IP rating	Power
<a href="#">HL-77962-20</a>	0.06 to 8.0	I/P Easy-Load® 77601-10	C-Flex® ULTRA I/P 73 06434-73; 3 m (10 ft)	I/P 26, I/P 73, I/P 82	07591-20	6 to 650	IP33	90 to 130 VAC, 4.4 A; and 190 to 260 VAC, 2.2 A

<sup>†</sup>Flow range with included tubing; extend the flow range of these systems with additional sizes of tubing; order on pages 126–130.

[HL-07557-51](#) Extension cable, 2.7 m (9 ft) for benchtop modular drive; extend distance between motor and controller.

[HL-77595-35](#) Foot switch, DB9 male with 1.8-m (6-ft) cable.

[HL-07595-47](#) Cable assembly, DB9 male connector and 7.9-m (25-ft) cable with stripped wire terminal ends. Use for remote control.

[HL-17050-01](#) NIST-traceable calibration with data for peristaltic pump drive.

### COMPLETE SYSTEM INCLUDES:

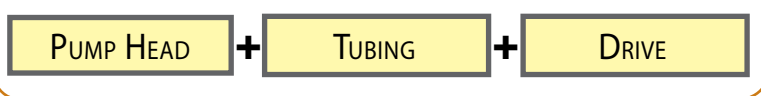

## I/P® MODULAR PUMP WITH WALL-MOUNT CONTROLLER

### APPLICATIONS

- ▶ pH control
- ▶ Process control
- ▶ Food applications
- ▶ Printing
- ▶ Dispensing culture media
- ▶ Dye dispensing
- ▶ Plating chemical pump
- ▶ Corrosive fluid transfer
- ▶ Slurry pump

### BENEFITS

- ▶ Modular format lets you separate drive and controller for convenient placement; a 1.8-m (6-ft) control cable is included. Extend that distance with optional 2.7 m (9 ft) extension cable
- ▶ Drive and controller are IP66, NEMA 4X rated for use in washdown environments
- ▶ Three-digit LED shows motor speed (rpm)—confirm speed setting at a glance
- ▶ Remote control via 18-pin weather-resistant connection on bottom of controller; control speed, direction, start/stop

### FEATURES

- ▶ ½-hp, continuous-duty drive
- ▶ ±0.25% drive speed accuracy
- ▶ Motor and controller are connected by a 1.8-m (6-ft) weather-resistant cable

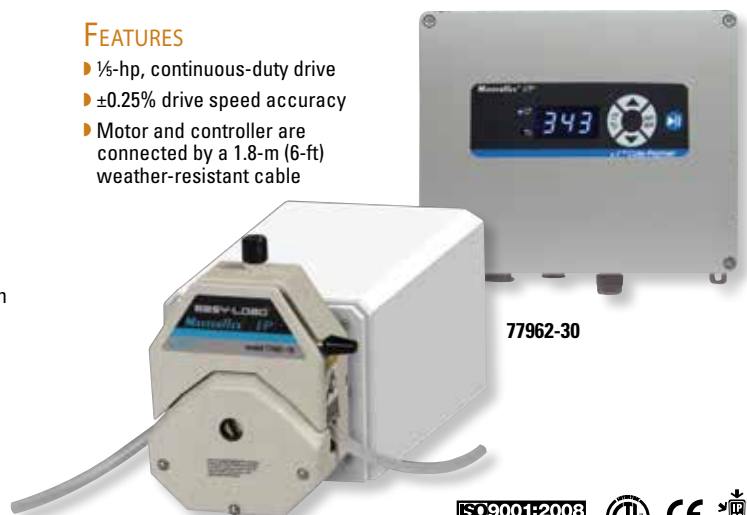

77962-30



### SPECIFICATIONS & ORDERING INFORMATION

Catalog number	Flow range <sup>†</sup> (LPM)	Pump head included	Tubing included	Tubing sizes accepted	Drive included	Drive speed range (rpm)	Drive IP rating	Power
<a href="#">HL-77962-30</a>	0.06 to 8.0	I/P Easy-Load® 77601-10	C-Flex® ULTRA I/P 73 06434-73; 3 m (10 ft)	I/P 26, I/P 73, I/P 82	07591-30	6 to 650	IP66	90 to 130 VAC, 4.4 A; and 190 to 260 VAC, 2.2 A

<sup>†</sup>Flow range with included tubing; extend the flow range of these systems with additional sizes of tubing; order on pages 126–130.

[HL-07557-51](#) Extension cable, 2.7 m (9 ft) for washdown modular drive; extend distance between motor and controller.

[HL-07595-43](#) Washdown foot switch, 18-pin round with 1.8-m (6-ft) cable.

[HL-77300-32](#) Cable assembly, 18-pin round connector and 7.9-m (25-ft) cable with stripped wire terminal ends. Use for remote control.

[HL-17050-01](#) NIST-traceable calibration with data for peristaltic pump drive.



## I/P® PROCESS PUMP

### APPLICATIONS

- ▶ Media transfer
- ▶ Filling/emptying large carboys and bags
- ▶ Pumping dyes and pigments
- ▶ Pumping fermentation chemicals
- ▶ Sewage and sludge sampling

### BENEFITS

- ▶ Brushless, maintenance-free motor
- ▶ Light enough to carry with one hand
- ▶ Displays percent speed from 5 to 100% for repeatable control
- ▶ Sealed, IP55-rated housing sprays or wipes down for easy cleaning
- ▶ Powerful enough to drive two Easy-Load® pump heads for twice the flow rate

### FEATURES

- ▶ 1/3-hp, continuous-duty brushless drive
- ▶ ±0.25% PWM speed control accuracy
- ▶ Precise, three-turn speed control
- ▶ Sealed membrane keypad



77963-10

### SPECIFICATIONS & ORDERING INFORMATION



Catalog number	Flow range† (LPM)	Pump head included	Tubing included	Tubing sizes accepted	Drive included	Drive speed range (rpm)	Drive IP rating	Power (50/60 Hz)
<a href="#">HL-77963-10</a>	0.4 to 8.0	I/P Easy-Load® 77601-10	C-Flex® ULTRA I/P 73 06434-73; 3 m (10 ft)	I/P 26, I/P 73, I/P 82	77410-10	33 to 650	IP55	90 to 130 VAC, 4.5 A; and 220 to 260 VAC, 2.6 A
<a href="#">HL-77963-20</a>	0.7 to 17.0	I/P High-Performance 77600-62	Tygon® E-LFL I/P 88 06440-88; 1 m (3 ft)	I/P 70, I/P 88, I/P 89				

†Flow range with included tubing; extend the flow range of these systems with additional sizes of tubing; order on pages 126–130.

[HL-17050-01](#) NIST-traceable calibration for peristaltic pump drive.

## I/P® PROCESS PUMPS WITH REMOTE CAPABILITY

### APPLICATIONS

- ▶ Purification/filtration/media transfer
- ▶ Automated process
- ▶ Food and pharma process pump
- ▶ Pumping anti-foaming agents
- ▶ Chemical feed and metering
- ▶ Wastewater process pump

### BENEFITS

- ▶ Remote control capability via fluid-resistant I/O connector on back of drive (requires 77300-32 remote cable kit—order separately)
- ▶ Analog outputs include “pump ready” signal (order 77300-32 remote cable kit below)
- ▶ Displays percent speed from 5 to 100% for precise, repeatable control
- ▶ Sealed, IP55-rated housing sprays or wipes down for easy cleaning
- ▶ Brushless, maintenance-free motor

### FEATURES

- ▶ 1/3-hp, continuous-duty brushless drive
- ▶ ±0.25% PWM speed control accuracy
- ▶ Sealed membrane keypad



77965-10

### SPECIFICATIONS & ORDERING INFORMATION



Catalog number	Flow range† (LPM)	Pump head included	Tubing included	Tubing sizes accepted	Drive included	Drive speed range (rpm)	Drive IP rating	Power (50/60 Hz)
<a href="#">HL-77965-00</a>	0.4 to 8.0	I/P Easy-Load® 77601-10	C-Flex® ULTRA I/P 73 06434-73; 3 m (10 ft)	I/P 26, I/P 73, I/P 82	77411-00	33 to 650	IP55	90 to 130 VAC, 4.5 A; and 220 to 260 VAC, 2.6 A
<a href="#">HL-77965-10</a>	0.7 to 17.0	I/P High-Performance 77600-62	Tygon® E-LFL I/P 88 06440-88; 1 m (3 ft)	I/P 70, I/P 88, I/P 89				

†Flow range with included tubing; extend the flow range of these systems with additional sizes of tubing; order on pages 126–130.

[HL-07595-43](#) Washdown foot switch.

[HL-17050-01](#) NIST-traceable calibration for peristaltic pump drive.

[HL-77300-32](#) Remote cable kit.

## I/P® DIGITAL MODULAR PUMP

### APPLICATIONS

- ▶ Yogurt dispensing pump
- ▶ Flavor concentrate/food additive dispenser
- ▶ Photochemical dispenser
- ▶ Shampoo dispenser

### FEATURES

- ▶ ¾-hp, continuous-duty drive
- ▶ ±0.1% drive speed accuracy
- ▶ Controller/drive connected by a 1.8-m (6-ft) cable

### BENEFITS

- ▶ Modular format lets you separate drive and controller for convenient placement; a 1.8-m (6-ft) control cable is included. Extend that distance with optional 2.7-m (9-ft) extension cable
- ▶ Four-line graphical LCD shows four operating modes: continuous run, volume dispense, time dispense, and copy dispense
- ▶ Set time interval (delay) between dispense cycles for hands-free dispensing; antidrip function ensures dispensing accuracy
- ▶ Remote control via 25-pin (DB25) female connection on back of controller; control speed, direction, start/stop, and prime



77970-40

### SPECIFICATIONS & ORDERING INFORMATION

Catalog number	Flow range† (LPM)	Pump head included	Tubing included	Tubing sizes accepted	Drive included	Drive speed range (rpm)	Drive IP rating	Power
<a href="#">HL-77970-40</a>	0.001 to 8.0	I/P Easy-Load® 77601-10	C-Flex® ULTRA I/P 73 06434-73; 3 m (10 ft)	I/P 26, I/P 73, I/P 82	07594-00	0.1 to 650	IP33	90 to 130 VAC, 4.5 A; and 190 to 260 VAC, 2.5 A

†Flow range with included tubing; extend the flow range of these systems with additional sizes of tubing; order on pages 126–130.

[HL-77301-82](#) Extension cable, 2.7-m (9-ft) for benchtop modular drive; extend distance between motor and controller.

[HL-07523-92](#) Foot switch, momentary start/stop; 1.8-m (6-ft) cable.

[HL-07523-95](#) Cable assembly, DB25 male connector and 7.9-m (25-ft) cable with stripped wire ends for remote control.

[HL-17050-01](#) NIST-traceable calibration with data for peristaltic pump drive.

### COMPLETE SYSTEM INCLUDES:

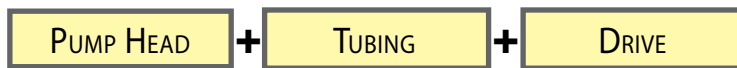

## I/P® DIGITAL MODULAR PUMP WITH WALL-MOUNT CONTROLLER

### APPLICATIONS

- ▶ Transfer cell culture media
- ▶ Flavor concentrate/food additive dispenser
- ▶ Photochemical dispenser

### FEATURES

- ▶ ¾-hp, continuous-duty drive
- ▶ ±0.1% drive speed accuracy
- ▶ Controller/drive connected by a 1.8-m (6-ft) cable

### BENEFITS

- ▶ Modular format lets you separate drive and controller for convenient placement; a 1.8-m (6-ft) control cable is included. Extend that distance with optional 2.7-m (9-ft) extension cable
- ▶ Drive and controller are IP66, NEMA 4X rated for use in washdown environments
- ▶ Four-line graphical LCD shows four operating modes: continuous run, volume dispense, time dispense, and copy dispense
- ▶ Set time interval (delay) between dispense cycles for hands-free dispensing; antidrip function ensures dispensing accuracy
- ▶ Remote control via 31-pin weather-resistant connection on bottom of controller; control speed, direction, start/stop, and prime



77970-50

### SPECIFICATIONS & ORDERING INFORMATION

Catalog number	Flow range† (LPM)	Pump head included	Tubing included	Tubing sizes accepted	Drive included	Drive speed range (rpm)	Drive IP rating	Power
<a href="#">HL-77970-50</a>	0.001 to 8.0	I/P Easy-Load® 77601-10	C-Flex® ULTRA I/P 73 06434-73; 3 m (10 ft)	I/P 26, I/P 73, I/P 82	07594-10	0.1 to 650	IP66	90 to 130 VAC, 4.5 A; and 190 to 260 VAC, 2.5 A*

†Flow range with included tubing; extend the flow range of these systems with additional sizes of tubing; order on pages 126–130.

[HL-77301-82](#) Extension cable, 2.7 m (9 ft) for washdown modular drive; extend distance between motor and controller.

[HL-07575-84](#) Washdown foot switch, momentary start/stop; 1.8-m (6-ft) cable.

[HL-07575-80](#) Cable assembly; 31-pin round water-tight connector and cable with stripped wire ends for remote control, 8.3-m (25-ft) length.

[HL-17050-01](#) NIST-traceable calibration with data for peristaltic pump drive.





## I/P® DIGITAL PROCESS PUMP

### APPLICATIONS

- ▶ Pharma and cosmetics process pump
- ▶ Sanitary food/dairy process pump
- ▶ Automated process pump
- ▶ Dosing/metering additives
- ▶ Bulk media transfer and dispensing
- ▶ Large-volume buffer transfer
- ▶ Pilot scale fermentation

### BENEFITS

- ▶ Four-line graphical LCD shows four operating modes: continuous run, volume dispense, time dispense, and copy dispense
- ▶ Brushless motor virtually eliminates maintenance—no motor brushes to replace
- ▶ Programmable dispense interval for automated dispensing
- ▶ Antidrip function ensures dispensing accuracy
- ▶ Batch count lets you set the desired number of batches and displays number of batches completed
- ▶ Programmed calibration ensures flow rate accuracy
- ▶ Sealed housing for easy washdown in process environments; available with either 316 stainless steel or powder-coated steel housing
- ▶ Tach output for precise speed control and feedback

### FEATURES

- ▶ 3/4-hp continuous-duty brushless drive
- ▶ ±0.1% PWM speed control accuracy with tach output
- ▶ Analog remote control of speed, start/stop, and direction (order remote accessories below)
- ▶ Sealed membrane keypad with lockout
- ▶ IP66, NEMA 4X rated



77964-20



77964-30

### SPECIFICATIONS & ORDERING INFORMATION

ISO9001:2008  
CERTIFIED SUPPLIER



Catalog number	Flow range† (LPM)	Pump head included	Tubing included	Tubing sizes accepted	Drive included	Drive speed range (rpm)	Drive IP rating	Power
<b>Digital process pump with 316 stainless steel housing</b>								
<a href="#">HL-77964-20</a>	0.001 to 8.0	I/P Easy-Load® 77601-10	C-Flex® ULTRA I/P 73 06434-73; 3 m (10 ft)	I/P 26, I/P 73, I/P 82	77420-10	0.1 to 650	IP66	90 to 130 VAC, 4.5 A; and 190 to 260 VAC, 2.5 A
<b>Digital process pump with powder-coat steel housing</b>								
<a href="#">HL-77964-30</a>	0.001 to 8.0	I/P Easy-Load® 77601-10	C-Flex ULTRA I/P 73 06434-73; 3 m (10 ft)	I/P 26, I/P 73, I/P 82	77420-20	0.1 to 650	IP66	90 to 130 VAC, 4.5 A; and 190 to 260 VAC, 2.5 A

†Flow range with included tubing; extend the flow range of these systems with additional sizes of tubing; order on pages 126–130.

[HL-07575-84](#) Washdown foot switch, momentary start/stop; 1.8-m (6-ft) cable.

[HL-07575-80](#) Cable assembly; 31-pin round water-tight connector and cable with stripped wire ends for remote control, 8.3-m (25-ft) length.

[HL-17050-01](#) NIST-traceable calibration with data for peristaltic pump drive.



### FILLER/DISPENSING NOZZLES

- ▶ Maximize the speed, precision, and accuracy of dispensing and filling applications
- ▶ Minimize splashing and dripping when dispensing into narrow- or wide-mouth containers
- ▶ Dimensional tolerances of ±0.05% for assured repeatability

These nozzles combine the ease of plastic components with the accuracy and reliability of a stainless steel tube. Tight dimensional tolerances help to ensure precision in your dispensing applications. Nozzles feature a 316L stainless steel tube and a polycarbonate base with hose barb adapter. Materials comply with FDA, USDA and USP Class VI requirements. All filler nozzles are sterilizable by ethylene oxide, autoclaving, or gamma irradiation.

Catalog number	Tubing ID
<a href="#">HL-30619-06</a>	1/32"
<a href="#">HL-30619-01</a>	1/16"
<a href="#">HL-30619-07</a>	1/8"
<a href="#">HL-30619-02</a>	3/16"
<a href="#">HL-30619-08</a>	1/4"
<a href="#">HL-30619-03</a>	5/16"
<a href="#">HL-30619-09</a>	3/8"
<a href="#">HL-30619-04</a>	1/2"
<a href="#">HL-30619-10</a>	5/8"
<a href="#">HL-30619-05</a>	3/4"

30619-02



## I/P® MULTICHANNEL FIXED-SPEED PUMPS

### APPLICATIONS

- ▶ Transferring printing inks and adhesives
- ▶ Pumping dyes in textile manufacture
- ▶ Feeding solutions and additives to multiple process lines
- ▶ Pumping adhesives for envelope manufacture

### BENEFITS

- ▶ IP55-rated drive for washdown
- ▶ Reduced noise
- ▶ Minimal downtime and cleanup for fluid or color changeover
- ▶ Reversible motor for line purge or bi-directional pumping
- ▶ Reduced maintenance—lower cost of ownership
- ▶ Low shear, reduced air entrapment, and reduced heat transfer to fluid

### FEATURES

- ▶ ½-hp, fixed-speed motor/adaptor
- ▶ ±1% speed control accuracy



**A**



**B**

### FREE TUBING TEST KIT!

#### Can't find your chemical in the tables?

Request your FREE tubing kit to test compatibility of your chemicals against different tubing formulations. Request item HL-00101-10.

**Call or go online to request your FREE test kit today!**



### SPECIFICATIONS & ORDERING INFORMATION

ISO9001:2008 CERTIFIED SUPPLIER  

Catalog number	Flow range <sup>†</sup> (LPM)	Pump heads included	Tubing included	Tubing sizes accepted	Drive included	Drive speed (rpm) <sup>‡</sup>	Drive IP rating	Power (50/60 Hz)
<b>A I/P Three-channel fixed-speed pump</b>								
<a href="#">HL-07588-80</a>	2.3 per channel	I/P Easy-Load®	C-Flex® ULTRA I/P 73	I/P 26, I/P 73,	07588-60	180	IP55	90 to 130 VAC, 8.0 A
<a href="#">HL-07588-87</a>	1.9 per channel	77601-10	06434-73; 3 m (10 ft)	I/P 82		150		190 to 260 VAC, 4.0 A
<b>B I/P Four-channel fixed-speed pump</b>								
<a href="#">HL-07588-90</a>	2.3 per channel	I/P Easy-Load	C-Flex ULTRA I/P 73	I/P 26, I/P 73,	07588-60	180	IP55	90 to 130 VAC, 3.0 A
<a href="#">HL-07588-97</a>	1.9 per channel	77601-10	06434-73; 3 m (10 ft)	I/P 82		150		190 to 260 VAC, 4.0 A

<sup>†</sup>Flow range with included tubing; extend the flow range of these systems with additional sizes of tubing; order on pages 126–130.

<sup>‡</sup>Speed modified via NEMA adaptor.

### 24-HOUR PROTECTION!

The Liqui-Sense® emergency cut-off system protects you from pumping problems 24-hours-a-day. Detection of a leak or an unusual liquid level in a tank signals the Liqui-Sense® controller to turn off your pump and turn on a backup. You can even program it to call a specified phone number in the event of a detected problem. The controller measures approximately 21 x 16 x 8 cm (8" x 6¼" x 3"). Please see pages 160–161 for a complete description and ordering information.







## I/P® AIR-POWERED PUMPS

### APPLICATIONS

- ▶ Transfer of hazardous materials
- ▶ Transfer of printing inks
- ▶ Production fermentation

### BENEFITS

- ▶ Safe where electrical power not advisable
- ▶ Operates from your compressor
- ▶ Easy tubing changes
- ▶ High horsepower in a compact size
- ▶ Cooler operation
- ▶ Smooth-starting, low-maintenance motor

### FEATURES

- ▶ ¾-hp continuous-duty drive
- ▶ ±10% drive speed accuracy
- ▶ Complete with regulator with 5-µm air filter and ¼" NPT(F) connection, automatic lubricator, 0 to 2 bar (0 to 30 psi) pressure gauge, and muffler.
- ▶ ATEX system 77980-10 is ATEX Zone 2 rated: EEx II 3 G c IIC T6; NEC Class I, Division 2, Groups A, B, C, D, T6



77980-10

ISO9001:2008  
CERTIFIED SUPPLIER



ATEX  
Zone 2  
77980-10

### SPECIFICATIONS & ORDERING INFORMATION

Catalog number	Flow range <sup>†</sup> (LPM)	Pump head included	Tubing included	Tubing sizes accepted	Drive included	Drive speed range (rpm)	Drive IP rating	Power
<a href="#">HL-77980-00</a>	1.2 to 8.0	I/P Easy-Load® 77601-10	C-Flex® ULTRA I/P 73 06434-73; 3 m (10 ft)	I/P 26, I/P 73, I/P 82	07589-30	100 to 650	IP34	0.08 to 0.7 m <sup>3</sup> /min (3 to 25 cfm) at 1.4 to 6.9 bar (20 to 100 psi)
<b>ATEX Zone 2 rated I/P air-powered pump system</b>								
<a href="#">HL-77980-10</a>	1.2 to 8.0 <sup>‡</sup>	I/P Easy-Load 77601-80	N/A <sup>††</sup>	I/P 26, I/P 73, I/P 82	07589-30	100 to 650	IP34	0.08 to 0.7 m <sup>3</sup> /min (3 to 25 cfm) at 1.4 to 6.9 bar (20 to 100 psi)

<sup>†</sup>Flow range with included tubing; extend the flow range of these systems with additional sizes of tubing; order on pages 126-130.

<sup>‡</sup>For ATEX pump system, flow rates will depend on tubing size selected.

<sup>††</sup>ATEX pump systems do not include tubing; select tubing to be compatible with your fluid and the parameters of your application.

**Note:** For safe operation of Masterflex air-powered pumps, ground pump carefully to protect from static electricity.

### COMPLETE SYSTEM INCLUDES:

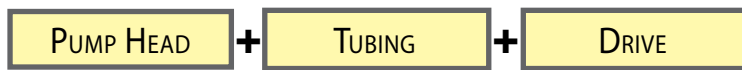

## I/P® HAZARDOUS-DUTY PUMP

### APPLICATIONS

- ▶ Transfer of chemicals where hazardous vapors are present
- ▶ Transfer of heat-sensitive fluids
- ▶ Production fermentation

### BENEFITS

- ▶ Ideal where electricity is unsafe
- ▶ Easy tubing changes
- ▶ Variable-speed for wide flow ranges

### FEATURES

- ▶ ¼-hp continuous-duty drive
- ▶ ±10% drive speed accuracy



77981-10

ISO9001:2008  
CERTIFIED SUPPLIER



Motor only

### SPECIFICATIONS & ORDERING INFORMATION

Catalog number	Flow range <sup>†</sup> (LPM)	Pump head included	Tubing included	Tubing sizes accepted	Drive included	Drive speed range (rpm)	Drive IP rating	Power
<a href="#">HL-77981-10</a>	0.12 to 5.3	I/P Easy-Load® 77601-10	C-Flex® ULTRA I/P 73 06434-73; 3 m (10 ft)	I/P 26, I/P 73, I/P 82	07583-50	10 to 430	IP21	115 VAC, 60 Hz

<sup>†</sup>Flow range with included tubing; extend the flow range of these systems with additional sizes of tubing; order on pages 126-130.

## SELECTION GUIDE FOR B/T® PUMPS

Choose B/T pumps when your application requires high flow rates and rugged dependability. Every B/T pump offers a powerful motor ideal for transfer of viscous or shear-sensitive materials.

### FEATURES INCLUDE:

- ▶ A Rapid-Load® occlusion mechanism slides the tubing occlusion bed out of the way for easy tube loading and improved occlusion of the tubing when closed
- ▶ Cast-aluminum housing provides quieter, more rugged operation—epoxy-powder coating resists chemical corrosion
- ▶ Tubing sizes B/T 87 and B/T 91 provide better performance in higher-pressure applications
- ▶ Easy-opening cover swings away to allow for CIP or SIP protocols
- ▶ PerfectPosition™ tubing retention marks indicate the exact length of tubing needed to give the best tubing performance and life
- ▶ Safety interlock shuts the pump down when the head is opened

### Watch the VIDEO!

Watch a video tutorial on how to load B/T® pumps.  
[Masterflex.com/video](http://Masterflex.com/video)



### HOW TO LOAD YOUR PUMP HEAD





**1. Line up PerfectPosition™ tubing retention marks and wrap tubing around the rollers.**



**2. Secure the tubing in the upper and lower retainers.**

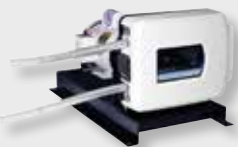
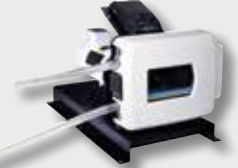

**3. Close the door and secure the latch.**

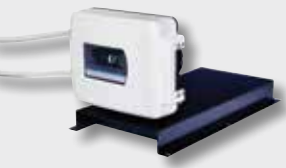
	Description	Flow range	Fixed speed (rpm)	Variable speed (rpm)	Reversible	Remote control capabilities	Special features	Page number
Analog	FIXED-SPEED							
		115 VAC: 17.7 or 42 LPM; (4.7 or 11.1 GPM) 230 VAC: 14.7 or 35 LPM; (3.9 or 9.4 GPM)	271, 321	—	✓	—	Economical; simple operation; easy setup	158
Analog	VARIABLE-SPEED							
		0.71 to 42 LPM (0.19 to 11.1 GPM)	—	12 to 321	✓	—	Detachable controller for flexible setup; broad flow range	154–155
Digital	MODULAR DISPENSING							
		0.65 to 42 LPM (0.17 to 11.1 GPM)	—	11 to 321	✓	Speed, direction, start/stop, prime	Digital dispensing with calibration; separate motor and controller for convenient setup	156–157
Specialty	AIR-POWERED							
		2.1 to 42 LPM (0.55 to 11.1 GPM)	—	35 to 321	—	—	Use where electricity is unsafe or impractical. Classified for use in ATEX Zone 2 applications.	154–155
Specialty	PUMP HEADS							
		Flow rates and features depend on motor selection					Allows you to mount the B/T Rapid-Load pump head to your own 56C or IEC72/ISO 71 motors.	

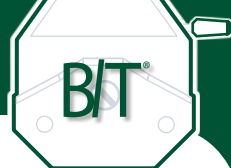

## B/T<sup>®</sup> PERFECTPOSITION<sup>™</sup> PUMP TUBING FOR 77110- AND 77111-SERIES RAPID-LOAD<sup>®</sup> PUMP HEADS

- ▶ Ensure optimal performance from your Masterflex pump
- ▶ PerfectPosition tubing retention marks indicate the exact placement of tubing in the pump head to provide the best performance and life of the tubing
- ▶ Custom extruded to fit 77110-series and 77111-series Masterflex B/T pumps and pump heads
- ▶ Engineered for long life in peristaltic pump applications

These Masterflex B/T tubing sizes 87 and 91 are optimized to provide better performance in higher-pressure applications. Each tubing size is manufactured to extremely close tolerances that match our B/T pump heads. These tight tolerances ensure accurate, repeatable flow, and long tubing life. Plus, the PerfectPosition tubing retention marks indicate the best placement of the tubing within the pump head.

Choose from a variety of tubing formulations below to allow for optimal performance in the most challenging applications. For detailed formulation descriptions and specifications, see pages 20–24.

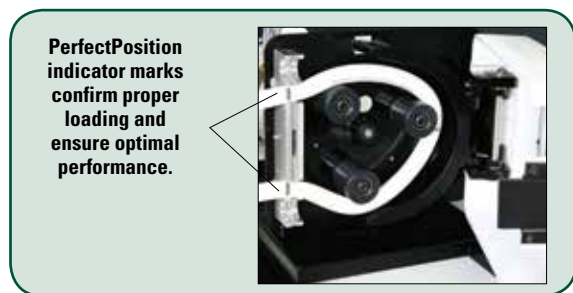

### Specifications

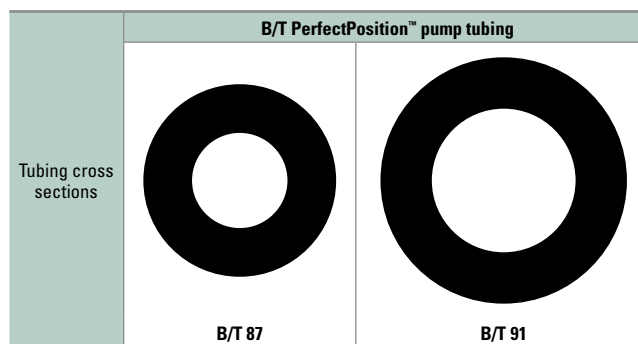

Pump tubing size	PerfectPosition <sup>™</sup> pump tubing	
	B/T 87	B/T 91
Inside diameter (nominal)	12.7 mm (0.5")	19.0 mm (0.75")
Hose barb size	12.7 mm (½")	19.0 mm (¾")
Flow range (approximate) <sup>†</sup> with 11 to 321 rpm drive	0.67 to 18.9 LPM (0.17 to 5.0 GPM)	1.4 to 42 LPM (0.4 to 11.1 GPM)
Maximum pressure <sup>‡</sup>	2.4 bar (35 psi)	2.06 bar (30 psi)
Maximum vacuum <sup>‡</sup>	660 mm Hg (26" Hg)	
Suction lift <sup>‡</sup>	8.8 m H <sub>2</sub> O (29 ft H <sub>2</sub> O)	

<sup>†</sup>Determined under the following conditions: 0 bar (0 psi) at inlet, 0.03 bar (0.5 psi) at outlet; water temperature at 22°C (72°F). <sup>‡</sup>Actual performance varies depending on tubing formulation—values shown are for firm tubing.

### ORDERING INFORMATION

Pump tubing formulation		B/T PerfectPosition pump tubing		
		B/T 87		B/T 91
Silicone (platinum-cured)	3.0 m (10 ft) per pack		<a href="#">HL-96510-87</a>	<a href="#">HL-96510-91</a>
Silicone (peroxide-cured)	3.0 m (10 ft) per pack		<a href="#">HL-96400-87</a>	<a href="#">HL-96400-91</a>
BioPharm Plus silicone (platinum-cured)	3.0 m (10 ft) per pack		<a href="#">HL-96445-87</a>	<a href="#">HL-96445-91</a>
Puri-Flex <sup>™</sup>	3.0 m (10 ft) per pack		<a href="#">HL-96419-87</a>	<a href="#">HL-96419-91</a>
C-Flex <sup>®</sup>	3.0 m (10 ft) per pack		<a href="#">HL-06424-87</a>	<a href="#">HL-06424-91</a>
PharMed <sup>®</sup> BPT	3.0 m (10 ft) per pack		<a href="#">HL-06507-87</a>	<a href="#">HL-06507-91</a>
PharmaPure <sup>®</sup>	3.0 m (10 ft) per pack		<a href="#">HL-06437-87</a>	<a href="#">HL-06437-91</a>
Chem-Durance <sup>®</sup> Bio	3.0 m (10 ft) per pack		<a href="#">HL-06443-87</a>	<a href="#">HL-06443-91</a>
Tygon <sup>®</sup> E-LFL <b>NEW</b>	3.0 m (10 ft) per pack		<a href="#">HL-06440-87</a>	<a href="#">HL-06440-91</a>
Tygon <sup>®</sup> E-Food (B-44-4x) <b>NEW</b>	3.0 m (10 ft) per pack		<a href="#">HL-06418-87</a>	<a href="#">HL-06418-91</a>
Norprene <sup>®</sup> Food (A 60 F)	3.0 m (10 ft) per pack		<a href="#">HL-06399-87</a>	<a href="#">HL-06399-91</a>
Gore <sup>®</sup> Style 100SC <b>NEW</b>	69 cm (27") per pack		<a href="#">HL-96190-87</a>	<a href="#">HL-96190-91</a>
Gore <sup>®</sup> Style 400 <b>NEW</b>	69 cm (27") per pack		—	<a href="#">HL-06439-91</a>

## B/T® VARIABLE-SPEED PUMPS

### FEATURES/BENEFITS

#### All models

- ▶ PerfectPosition™ pump tubing ensures accurate loading and repeatable pressure and flow performance
- ▶ Tubing occlusion is optimum and automatic when door is closed and latched
- ▶ Safety interlock switch shuts off power when door is opened
- ▶ Controller and drive are IP56 rated for protection from dust and water spray

#### Variable-Speed Analog Pumps

- ▶ Flow rates: 0.71 to 42 LPM (0.19 to 11.1 GPM) with B/T tubing
- ▶ Controller and drive are connected by a 1.9 m (6 ft) cable for placement where convenient; detach controller from drive bracket for optional wall mounting
- ▶ Motor is reversible for pumping in either direction
- ▶ Simple single-turn potentiometer speed control

#### Air-Powered Pump

- ▶ Flow rates: 2.1 to 42 LPM (0.55 to 11.1 GPM) with B/T tubing
- ▶ Pump is ATEX Zone 2 rated: EEx II 3 G c IIC T6; NEC rated to Class 1, Division 2, Groups A, B, C, D, T6
- ▶ Use where electric power is unavailable, unsafe, or impractical

### SETUP

#### All Models

1. Open door.
2. Load PerfectPosition tubing by aligning retention marks with pump head tubing retainers.
3. Close door ensuring that latch is fully engaged.

#### Variable-Speed Analog Pumps

4. Select Forward or Reverse and turn power switch on.
5. Adjust pump speed / flow rate with single-turn potentiometer.

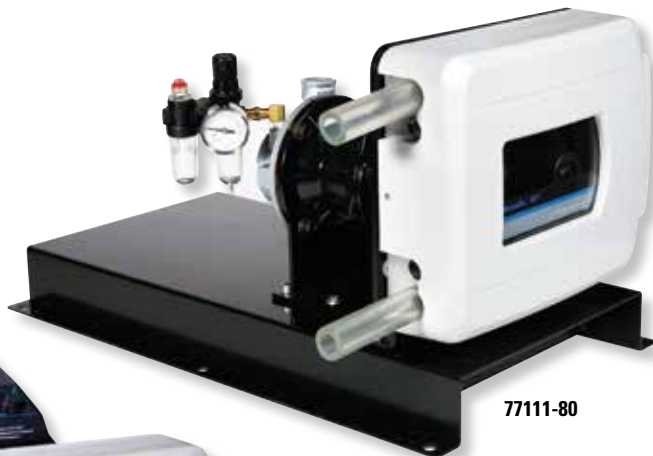

77111-80



77111-60

### SPEED CONTROL/CIRCUITRY

#### Variable-Speed Analog Pumps

- ▶ 1.9 m (6 ft) cable connects drive to detachable controller
- ▶ Single-turn potentiometer speed control
- ▶ Separate Forward/OFF/Reverse switch
- ▶ Speed not affected by variations in power line voltage (VAC) and frequency (Hz)
- ▶ 115 V meets UL61010-1, CSA C22.2 No. 61010-1; 230 V for CE mark: EN61010-1 (EU low voltage), EN61326 (EU EMC), and EN809 (EU machine directive)

#### Air-Powered Pump

- ▶ Air pressure filter/regulator inlet control
- ▶ Control speed with air inlet pressures from 4.1 bar (60 psi) to 6.9 bar (100 psi)
- ▶ For CE mark: EN809 (EU machine directive); EN13463-1 and EN13463-5 (EU ATEX Directive)



#### Air-Powered Pump

4. Connect compressed air line to 1/4" NPT connection on filter/regulator.
5. Turn on air source.
6. Adjust pump speed / flow rate with filter/regulator control knob.

### PUMP HEAD SPECIFICATIONS

- ▶ Corrosion-resistant Nylatron® rollers
- ▶ Stainless steel/powder-coated carbon steel frame
- ▶ Powder-coated cast aluminum and polycarbonate door
- ▶ Accepts PerfectPosition tubing sizes B/T 87 and B/T 91

### ORDERING INFORMATION

Catalog number	rpm	Power (50/60 Hz)
<b>Variable-speed analog pump</b>		
HL-77111-60	12 to 321	90 to 130 VAC
HL-77111-67		200 to 260 VAC
<b>Air-powered pump</b>		
HL-77111-80	35 to 321	Requires 30 cfm (0.85 m <sup>3</sup> /min) @ 4.1 bar (60 psi) minimum

### B/T PUMP TUBING FLOW RATE INFORMATION

Order Masterflex B/T pump tubing separately on page 153.

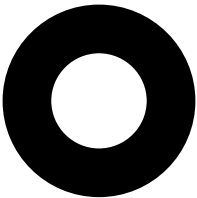
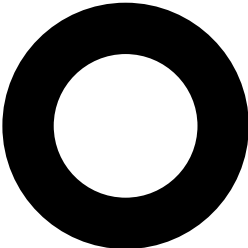
Tubing cross sections	B/T PerfectPosition™ tubing		Pump tubing size	PerfectPosition™ pump tubing	
				B/T 87	B/T 91
					Flow range <sup>†</sup> @ 12 to 321 rpm
		Flow range <sup>†</sup> @ 35 to 321 rpm	2.1 to 18.9 LPM (0.55 to 5.0 GPM)	4.0 to 42 LPM (1.06 to 11.1 GPM)	

<sup>†</sup>Determined under the following conditions: 0 psi at inlet, 0.5 psi at outlet; water temperature at 22°C (72°F).

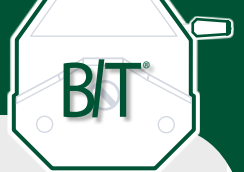

## SPECIFICATIONS for B/T\* Variable-Speed Pumps

Catalog number		<a href="#">HL-77111-60</a>	<a href="#">HL-77111-67</a>	<a href="#">HL-77111-80</a>
<b>Performance specifications</b>				
Flow capacity	0.71 to 42 LPM (0.19 to 11.1 GPM)		2.1 to 42 LPM (0.55 to 11.1 GPM)	
rpm	12 to 321		35 to 321	
Number of heads accepted	1 (supplied with drive)			
Maximum running torque	104 kg-cm (1440 oz-in)		208 kg-cm (2200 oz-in)	
Reversible	Yes		No	
<b>Electrical specifications</b>				
Voltage VAC (50/60 Hz)	90 to 130		200 to 260	
Current	6.5 A		3.3 A	
Fuse rating	8 A		4 A	
Motor type	Continuous duty, TENV, permanent-magnet DC		Requires 30 cfm (0.85 m <sup>3</sup> /min) @ 4.1 bar (60 psi) minimum	
Motor size	370 W (½ hp)		746 W (1 hp)	
Motor/speed control type	1-turn potentiometer		—	
Speed regulation	±5%		—	
Soft start/electronic brake	Yes / Yes		—	
<b>Physical specifications</b>				
Housing materials	Controller	ABS plastic		—
	Drive	Painted steel		
Pump head materials	Powder-coated carbon steel and cast aluminum, stainless steel, polycarbonate, with Nylatron® rollers			
IP rating†	Controller	IP56		—
	Drive	IP56		IP56
Agency listings	ETL, cETL, CE		CE	
Operating temperature	0 to 40°C (32 to 104°F)		0 to 40°C (32 to 104°F)	
Storage temperature	-20 to 60°C (-4 to 140°F)		-10 to 65°C (-14 to 149°F)	
Noise level	<75 dBA @ 1 m (39')		<88 dBA @ 1 m (39')	
Dimensions (L x W x H)	Controller	18.4 x 14.0 x 9.1 cm (7.3" x 5.5" x 3.6")	24.0 x 16.0 x 9.1 cm (9.5" x 6.3" x 3.6")	—
	Drive	68.6 x 40 x 42.4 cm (27.0" x 15.8" x 16.7")	68.6 x 40 x 44.2 cm (27.0" x 15.8" x 17.4")	68.6 x 40 x 38.4 cm (27.0" x 15.8" x 15.1")
Shipping weight	40.4 kg (89 lb)		28.5 kg (63 lb)	

†See page 194 for explanation of IP ratings.

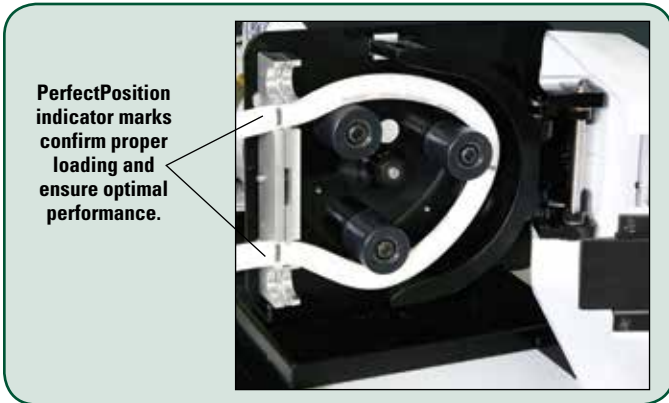

## Rubbermaid® FLAT-SHELF SERVICE CART

Perfect for transporting your B/T® pump around the process area. Flat-shelf design lets you easily move the pump on and off the cart and allows clearance for tubing. Transport up to 181 kg (400 lb). Comes with 12.7 cm (5") rubber casters (two swivel), seamless shelves and supports, radius corners, and molded handle.

**HL-09348-40** Plastic service cart, 112 cm L x 64.8 cm W x 85 cm H (44"L x 25½"W x 33½"H)

**5** year warranty

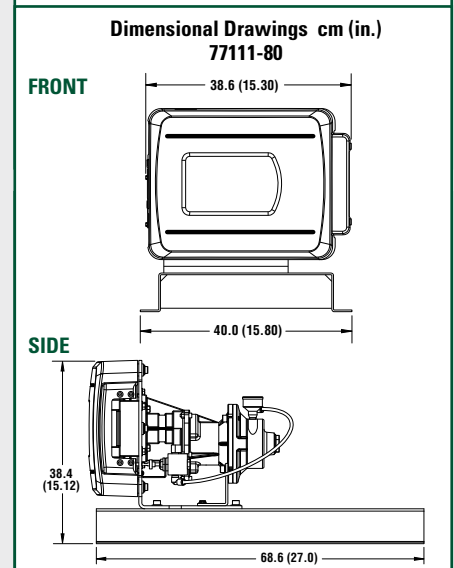
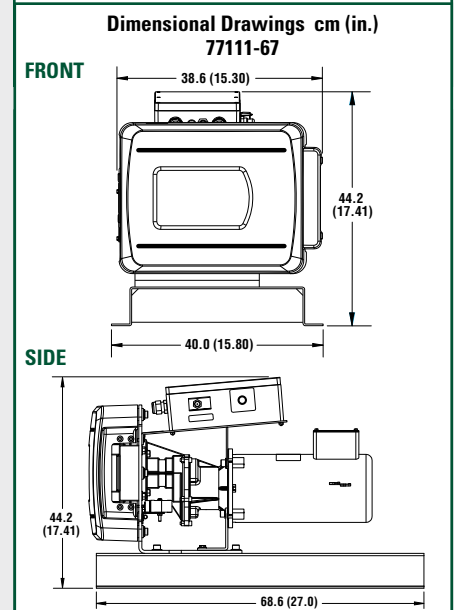
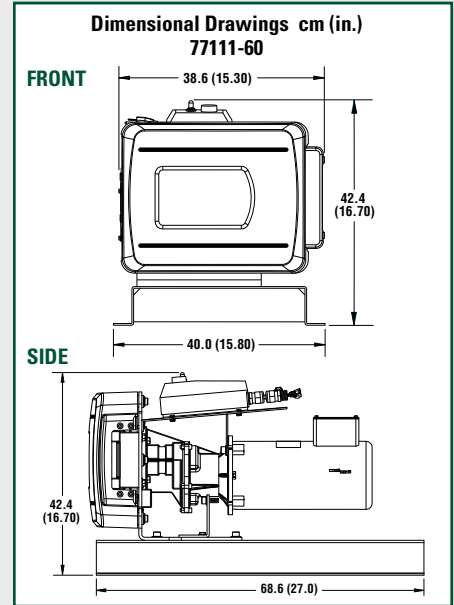

## B/T® VARIABLE-SPEED MODULAR DIGITAL PUMP

### FEATURES/BENEFITS

- Flow rates: 0.65 to 42 LPM (0.17 to 11.1 GPM) with B/T tubing
- Seven-segment, four-digit LED shows flow rate, rpm, copy number, and dispense volume
- Controller and drive are connected by a 1.9 m (6 ft) cable for placement where convenient; mount controller directly to drive with optional mounting bracket (order separately under "Accessories")
- PerfectPosition™ pump tubing ensures accurate loading and repeatable pressure and flow performance
- Tubing occlusion is optimum and automatic when door is closed and latched
- Safety interlock switch shuts off power when door is opened
- Controller and drive are IP56 rated for protection from dust and water spray
- Dispense by volume, copy, or time
- User selectable metric or English flow/volume units
- Drive stores one calibration value per tubing size even when turned off
- Motor is reversible for pumping in either direction; prime key runs motor at max speed to prime/purge tubing
- Keypad lockout prevents tampering and accidental changes

### DRIVE CONTROLS

- Protected power switch located on side of controller
- Lighted display indicates power is on
- Simple programming and operation of the following via sealed membrane keypad:
  - Tubing size
  - Flow rate
  - Flow direction
  - Flow units (metric or English)
  - Motor speed (rpm)
  - Total volume
  - Dispense (volume/copy/time)
  - Control mode (remote/internal)
  - Prime
  - Start/stop
  - Calibration

### SETUP

- Open door.
- Load PerfectPosition tubing by aligning retention marks with pump head tubing retainers.
- Close door ensuring that latch is fully engaged.
- Select motor direction.
- Prime and calibrate pump if required.
- Set flow rate through keypad.
- Press START key to begin pumping.

### PUMP HEAD SPECIFICATIONS

- Corrosion-resistant Nylatron® rollers
- Stainless steel/powder-coated carbon steel frame
- Powder-coated cast aluminum and polycarbonate door
- Accepts PerfectPosition tubing sizes B/T 87 and B/T 91

### SPEED CONTROL/CIRCUITRY

- Regulate motor through keypad, 4 to 20 mA, or 0 to 10 V signal
- Soft start for starts without power surges
- Speed not affected by variations in power line voltage (VAC) and frequency (Hz)
- Line filters reduce outside interference
- 115 V meets UL61010-1, CSA C22.2 No. 61010-1; 230 V for CE mark: EN61010-1 (EU low voltage), EN61326 (EU EMC), and EN809 (EU machinery directive)

### REMOTE CONTROL

- Speed control input: 0 to 20 mA, 4 to 20 mA, and 0 to 10 V (scaleable)
- Speed signal output: 0 to 20 mA, 4 to 20 mA, and 0 to 10 V (scaleable)
- START/STOP, CW/CCW, PRIME via contact closure
- Tach output: open collector
- Motor running indicator
- 18-pin watertight circular connection
- Handheld remote and cable options; order separately under "Accessories"

**B/T modular digital pump with IP56-rated controller 77111-40**



### CALIBRATION

- Select correct tubing size and flow rate.
- Press CAL; calibration volume appears.
- Press Start/Stop key. Stored memory dispenses specified volume, stops automatically.
- Weigh/measure the sample.
- Use UP/DOWN keys to adjust display to actual measured volume.
- Press SIZE to save setting and exit.

**Note:** Digital signal processor retains one calibration value for each tubing size, even when power is turned off.

### KEYPAD LOCK/UNLOCK FEATURE

- Press and hold FLOW key until dashes appear on display
- While holding FLOW key, press PRIME key five times
- Repeat above steps to unlock keypad



### ORDERING INFORMATION

Catalog number	rpm	Power (50/60 Hz)
HL-77111-40	11 to 321	90 to 130 VAC
HL-77111-47		200 to 260 VAC

### B/T PUMP TUBING FLOW RATE INFORMATION

Order Masterflex B/T pump tubing separately on page 153.

Tubing cross sections	B/T PerfectPosition™ tubing		Pump tubing size	PerfectPosition™ pump tubing	
	B/T 87	B/T 91		B/T 87	B/T 91
			Flow range† @ 11 to 321 rpm	0.65 to 18.9 LPM (0.17 to 5 GPM)	1.3 to 42 LPM (0.3 to 11.1 GPM)
			†Determined under the following conditions: 0 psi at inlet, 0.5 psi at outlet; water temperature at 22°C (72°F).		
			<b>Dispensing Precision</b>		
			Tubing size	Minimum dose (for ±0.5% precision)	Precision (±)
			B/T 87	5 L	25 mL
			B/T 91	10 L	50 mL

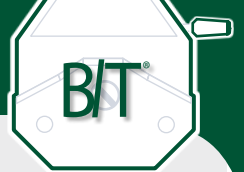

## SPECIFICATIONS for B/T\* Variable-Speed Modular Digital Pumps

Catalog number		<a href="#">HL-77111-40</a>	<a href="#">HL-77111-47</a>
<b>Performance specifications</b>			
Flow capacity		0.65 to 42 LPM (0.17 to 11.1 GPM)	
rpm		11 to 321	
Number of heads accepted		1 (supplied with drive)	
Maximum running torque		104 kg-cm (1440 oz-in)	
Reversible		Yes	
External control	Input	0 to 20 mA, 4 to 20 mA, 0 to 10 V; Start/stop, CW/CCW, Prime via contact closure	
	Output	0 to 20 mA, 4 to 20 mA, 0 to 10 V, TTL	
<b>Electrical specifications</b>			
Voltage VAC (50/60 Hz)		90 to 130	200 to 260
Current		6.5 A	3.3 A
Fuse rating		8 A	4 A
Motor type		Continuous duty, TENV, permanent-magnet DC	
Motor size		370 W (½ hp)	
Display		Four-digit, seven-segment LCD	
Motor/speed control type		Membrane keypad, microprocessor	
Speed regulation		±0.25%	
Soft start/electronic brake		Yes / Yes	
<b>Physical specifications</b>			
Housing materials	Controller	Painted aluminum	
	Drive	Painted steel	
Pump head materials		Powder-coated carbon steel and cast aluminum, stainless steel, polycarbonate, with Nylatron® rollers	
IP rating†	Controller	IP56	
	Drive	IP56	
Agency listings		ETL, cETL, CE	
Operating temperature		0 to 40°C (32 to 104°F)	
Storage temperature		-45 to 65°C (-49 to 149°F)	
Noise level		<75 dBA @ 1 m (39")	
Dimensions (L x W x H)	Controller	22.9 x 27.9 x 11.4 cm (9.0" x 11.0" x 4.5")	
	Drive	68.6 x 40 x 38.4 cm (27.0" x 15.8" x 15.1")	
Shipping weight		44.7 kg (98.5 lb)	

†See page 194 for explanation of IP ratings.

### ACCESSORIES

**HL-77300-32 Remote cable;** required for remote control operation, 7.6 m (25 ft)

**HL-77111-90 Controller mounting bracket;** mount controller directly to back of pump head

**Controller bracket 77111-90 shown mounted to back of pump head.**



### Rubbermaid® FLAT-SHELF SERVICE CART

Perfect for transporting your B/T® pump around the process area. Flat-shelf design lets you easily move the pump on and off the cart and allows clearance for tubing. Transport up to 181 kg (400 lb). Comes with 12.7 cm (5") rubber casters (two swivel), seamless shelves and supports, radius corners, and molded handle.

**HL-09348-40 Plastic service cart,** 112 cm L x 64.8 cm W x 85 cm H (44"L x 25½"W x 33½"H)

**5** year warranty



### Dimensional Drawings cm (in.) 77111-40, -47

FRONT

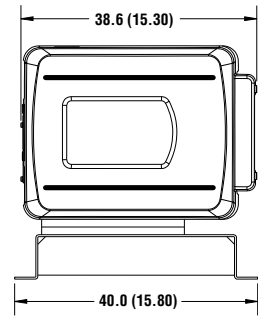

SIDE

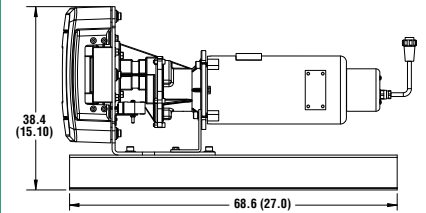

Controller

FRONT

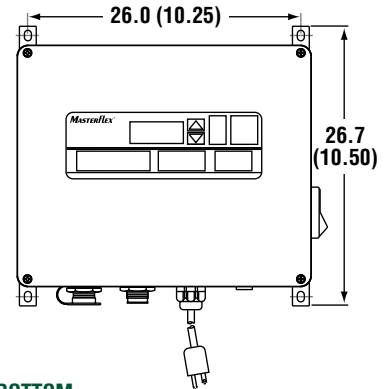

BOTTOM

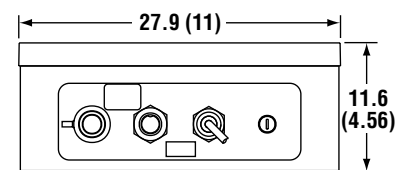

B/T TUBING ..... 153

ACCESSORIES ..... 160-167

TECHNICAL DATA ..... 172-206

## B/T® FIXED-SPEED PUMPS

### FEATURES/BENEFITS

- ▶ Flow rates: up to 42 LPM (0.17 to 11.1 GPM) with B/T tubing
- ▶ PerfectPosition™ pump tubing ensures accurate loading and repeatable pressure and flow performance
- ▶ Tubing occlusion is optimum and automatic when door is closed and latched
- ▶ Safety interlock switch shuts off power when door is opened
- ▶ Reversible motor lets you pump in either direction
- ▶ Pumps are IP56 rated for protection from dust and water spray

### SETUP

1. Open door.
2. Load PerfectPosition tubing by aligning retention marks with pump head tubing retainers.
3. Close door ensuring that latch is fully engaged.
4. Turn power on.

### PUMP HEAD SPECIFICATIONS

- ▶ Corrosion-resistant Nylatron rollers
- ▶ Stainless steel/powder-coated carbon steel frame
- ▶ Powder-coated cast aluminum and polycarbonate door
- ▶ Accepts PerfectPosition tubing sizes B/T 87 and B/T 91

### SPEED CONTROL/CIRCUITRY

- ▶ 115 V meets UL61010-1, CSA C22.2 No. 61010-1; 230 V for CE mark: EN61010-1 (EU low voltage), EN61326 (EU EMC), and EN809 (EU machine directive)



### ORDERING INFORMATION

Catalog number	rpm	Power (50/60 Hz)
<a href="#">HL-77111-30</a>	321	90 to 130 VAC
<a href="#">HL-77111-37</a>	271	200 to 260 VAC



B/T fixed-speed pump 77111-30

### SPECIFICATIONS

Catalog number	<a href="#">HL-77111-30</a>	<a href="#">HL-77111-37</a>
<b>Performance specifications</b>		
Flow capacity	42 LPM (11.1 GPM)	35 LPM (9.4 GPM)
rpm	321	271
Number of heads accepted	1 (supplied with drive)	
Maximum running torque	208 kg-cm (2200 oz-in)	
Reversible	Yes	
<b>Electrical specifications</b>		
Voltage VAC (50/60 Hz)	90 to 130	200 to 260
Current	12.6 A	6.3 A
Fuse rating	15 A	8 A
Motor type	Continuous-duty, TENV, permanent-magnet DC	
Motor size	746 W (1 hp)	
Mounting type	Direct drive	
Speed regulation	Fixed	
<b>Physical specifications</b>		
Housing materials	Painted steel	
Pump head materials	Powder-coated carbon steel and cast aluminum, stainless steel, polycarbonate, with Nylatron® rollers	
IP rating	IP56	
Agency listings	ETL, cETL, CE	
Operating temperature	0 to 40°C (32 to 104°F)	
Storage temperature	-10 to 65°C (14 to 149°F)	
Noise level	<75 dBA @ 1 m (39")	
Dimensions (L x W x H)	68.6 x 40.0 x 38.4 cm (27.0" x 15.8" x 15.1")	
Shipping weight	39.9 kg (88.0 lb)	

### B/T PUMP TUBING FLOW RATE INFORMATION

Order Masterflex B/T pump tubing separately on page 153.

Tubing cross sections	PerfectPosition™ tubing	
	B/T 87	B/T 91
Flow rate @ 321 rpm	18.9 LPM (5.0 GPM)	42 LPM (11.1 GPM)
Flow rate @ 271 rpm	16.0 LPM (4.2 GPM)	35 LPM (9.4 GPM)

Note: Determined under the following conditions: 0 bar (0 psi) at inlet, 0.03 bar (0.5 psi) at outlet; water temperature at 22°C (72°F).

### Dimensional Drawings cm (in.)

77111-30, -37

#### FRONT

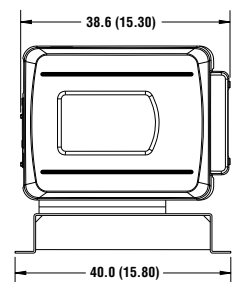

#### SIDE

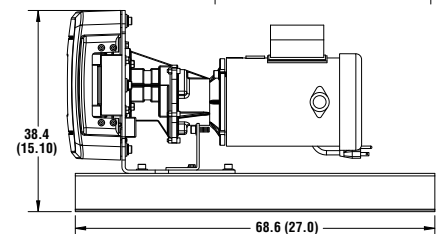



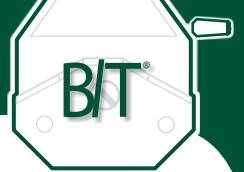

## B/T<sup>®</sup> RAPID-LOAD PUMP HEADS for 56C Frame or IEC-72-71-14F130 Frame Motors

### FEATURES/BENEFITS

- ▶ Flow rates: up to 42 LPM (0.17 to 11.1 GPM) with B/T tubing
- ▶ PerfectPosition™ pump tubing ensures accurate loading and repeatable pressure and flow performance
- ▶ Tubing occlusion is optimum and automatic when door is closed and latched
- ▶ Safety interlock switch shuts off power when door is opened
- ▶ Pump heads are IP56 rated for protection from dust and water spray

### SELECTION CRITERIA

1. Determine flow rate/gear ratio required (see "Flow Rate" table at right for sample values).
2. Determine type of motor mounting required: NEMA Type 56C or IEC-72-71-14F130 with B5 mounting, 160 mm flange.

### MOTOR SPECIFICATIONS

- ▶ Use a 1-hp (0.75 kW) motor; 1800 rpm maximum speed
- ▶ See motor options below
- ▶ Go to [www.coleparmer.com/Motors](http://www.coleparmer.com/Motors) for additional motor options and for VFD controllers to vary the speed of the motors listed below

### SETUP

1. Mount motor face to pump head gear reducer using the supplied hardware.
2. Follow manual instructions for wiring connections.
3. Open door and load PerfectPosition tubing by aligning retention marks with pump head tubing retainers.
4. Close door ensuring that latch is fully engaged.
5. Turn power on.

### PUMP HEAD SPECIFICATIONS

- ▶ Corrosion-resistant Nylatron rollers
- ▶ Stainless steel/powder-coated carbon steel frame
- ▶ Powder-coated cast aluminum and polycarbonate door
- ▶ Accepts PerfectPosition tubing sizes B/T 87 and B/T 91
- ▶ For CE mark: EN809 (EU machine directive)

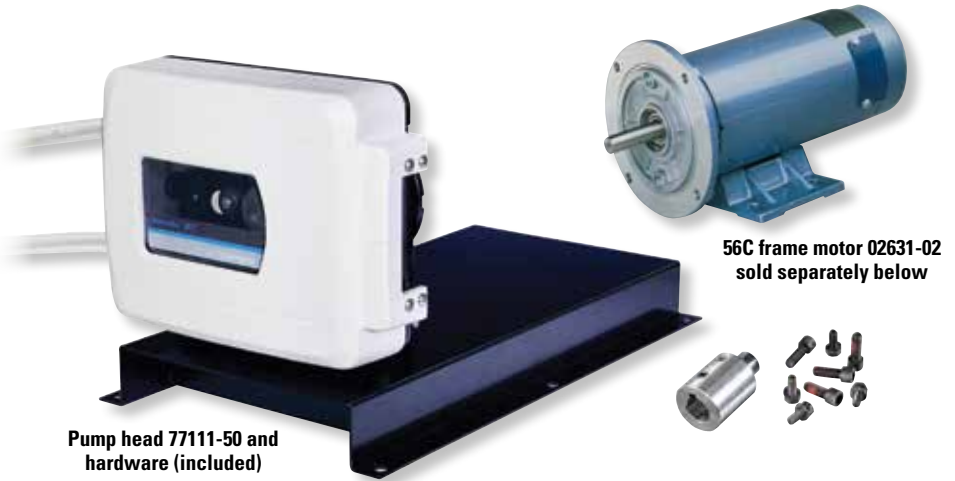

Pump head 77111-50 and hardware (included)

56C frame motor 02631-02 sold separately below



### ORDERING INFORMATION

Catalog number	For motor type
<a href="#">HL-77111-50</a>	NEMA Type 56C
<a href="#">HL-77111-55</a>	IEC-72-71-14F130

### B/T FLOW RATE INFORMATION

Motor rpm	Pump head gear ratio	Pump head rpm	PerfectPosition pump tubing	
			B/T 87	B/T 91
Flow/rev in L (gal.)			0.059 (0.0156)	0.131 (0.035)
1725	5.6:1	308	18.2 LPM	40.3 LPM
1750	5.6:1	313	18.5 LPM	41.0 LPM
1800	5.6:1	321	18.9 LPM	42.0 LPM

**Note:** Flow ranges are approximate—calculated under the following conditions: 0 psig at inlet and outlet; water temperature at 22°C (72°F).

### SPECIFICATIONS for B/T Pump Heads

Catalog number	<a href="#">HL-77111-50</a>	<a href="#">HL-77111-55</a>
<b>Performance specifications</b>		
Flow capacity	42 LPM (11.1 GPM)	
Maximum rpm	Pump head	321
	Motor	1800
Gear ratio	5.6:1	
Maximum running torque	208 kg-cm (2200 oz-in)	
<b>Physical specifications</b>		
Pump head materials	Powder-coated carbon steel and cast aluminum, stainless steel, polycarbonate, with Nylatron® rollers	
IP rating	IP56	
Agency listings	CE	
Operating temperature	0 to 40°C (32 to 104°F)	
Storage temperature	-10 to 65°C (14 to 149°F)	
Dimensions (L x W x H)	68.6 x 40.0 x 38.4 cm (27.0" x 15.8" x 15.1")	
Shipping weight	28.5 kg (63.0 lb)	

### MOTORS WITH 56C FRAME

Catalog number	hp	rpm	Type	Voltage	Frequency	Phase	Wattage	IP rating <sup>1</sup>	Overall dimensions (L x W x H)	Shpg wt kg (lb)
<b>DC Motors</b>										
<a href="#">HL-70071-40</a>	1	1750	TEFC	90 VDC	—	—	751	IP44	37.6 x 20.2 x 17 cm (14 <sup>3</sup> / <sub>16</sub> " x 7 <sup>15</sup> / <sub>16</sub> " x 6 <sup>1</sup> / <sub>16</sub> "	12.3 (27.0)
<a href="#">HL-70071-50</a>	1	1750	TEFC	180 VDC	—	—	716	IP44	37.6 x 20.2 x 17 cm (14 <sup>3</sup> / <sub>16</sub> " x 7 <sup>15</sup> / <sub>16</sub> " x 6 <sup>1</sup> / <sub>16</sub> "	11.8 (26.0)
<b>AC Motors</b>										
<a href="#">HL-71004-45</a>	1	1750	TEFC	115/208-230 VAC	50/60 Hz	1	750	IP44	31.3 x 22.8 x 21.2 cm (12 <sup>3</sup> / <sub>16</sub> " x 8 <sup>15</sup> / <sub>16</sub> " x 8 <sup>3</sup> / <sub>16</sub> "	11.1 (24.5)
<a href="#">HL-71015-45</a>	1	1750	WDN	208-230/460 VAC	50/60 Hz	3	750	IP53	35 x 22.2 x 17.2 cm (13 <sup>3</sup> / <sub>4</sub> " x 8 <sup>3</sup> / <sub>4</sub> " x 6 <sup>3</sup> / <sub>4</sub> "	11.3 (25.0)

<sup>1</sup>See page 194 for an explanation of IP ratings  
 TENV—Totally enclosed, nonventilating TEFC—Totally enclosed, fan-cooled WDN—Washdown

## LIQUI-SENSE® EMERGENCY CUT-OFF FLUID MONITORING SYSTEM

### FEATURES/BENEFITS

- ▶ Use with any style pump or where a fluid connection (potential leak source) exists
- ▶ Detects leaks and hazardous fluid loss
- ▶ Provides 24-hour protection
- ▶ Prevents flooding and pump damage
- ▶ If pump fails, system turns pump off and turns on back-up pump
- ▶ Two sensor options:
  - ◆ Liquid detector pad senses leaks
  - ◆ Float-switch—detects level changes
- ▶ Connections for one or two sensors with individual sensitivity adjustments
- ▶ Monitor two points in a single system or two independent systems
- ▶ Audible and visible alarms
- ▶ Alarm requires manual reset—prevents accidental restarting after detected problem

### SPECIFICATIONS for Liqui-Sense® Controller

Catalog number	<a href="#">HL-77096-00</a>	<a href="#">HL-77096-05</a>
<b>Performance Specifications</b>		
Audible alarm sound level	90 dBA	
<b>Electrical Specifications</b>		
Contact closure rating	30 VDC—1 A maximum	
Voltage VAC (50/60 Hz)	90 to 115	180 to 230
Current	10 A	6.3 A
<b>Physical Specifications</b>		
Housing material	ABS plastic	
IP rating*	IP22	
Operating temperature	0 to 40°C (32 to 104°F)	
Storage temperature	-45 to 65°C (-49 to 149°F)	
Humidity	0 to 85%	
Dimensions (L x W x H)	20.6 x 16 x 7.6 cm (8 1/8" x 6 3/8" x 3")	
Shipping weight	1.4 kg (3 lb)	

\*See page 194 for explanation of IP ratings.

### HOW TO ORDER

1. Order a Liqui-Sense controller.
2. Choose from two sensors to detect fluid process problems: the liquid detector pad senses fluid leakage, and the float-switch level sensor detects critical levels of fluid in a vessel.
3. Select optional 24-hour monitor, cord, or cables.

### 1 CONTROLLER ORDERING INFORMATION

Catalog number	Power	Socket
<a href="#">HL-77096-00</a>	90 to 115 VAC, 50/60 Hz	US Standard
<a href="#">HL-77096-05</a>	180 to 230 VAC, 50/60 Hz	IEC 320F

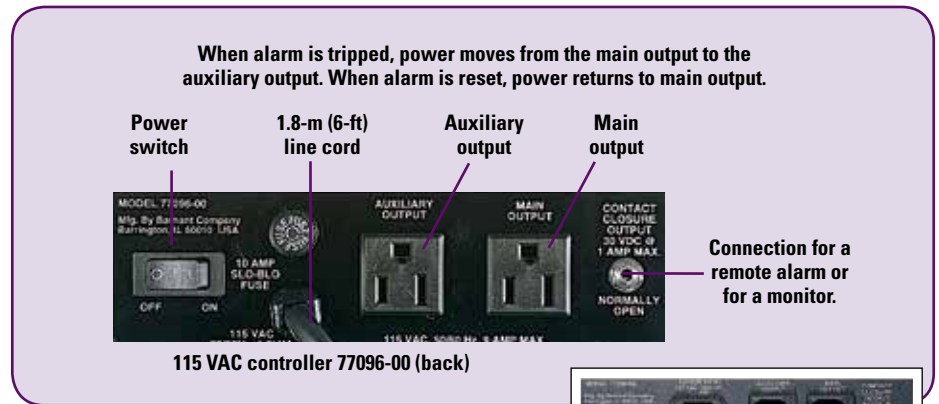

ISO9001:2008 CERTIFIED SUPPLIER CE 2 year warranty

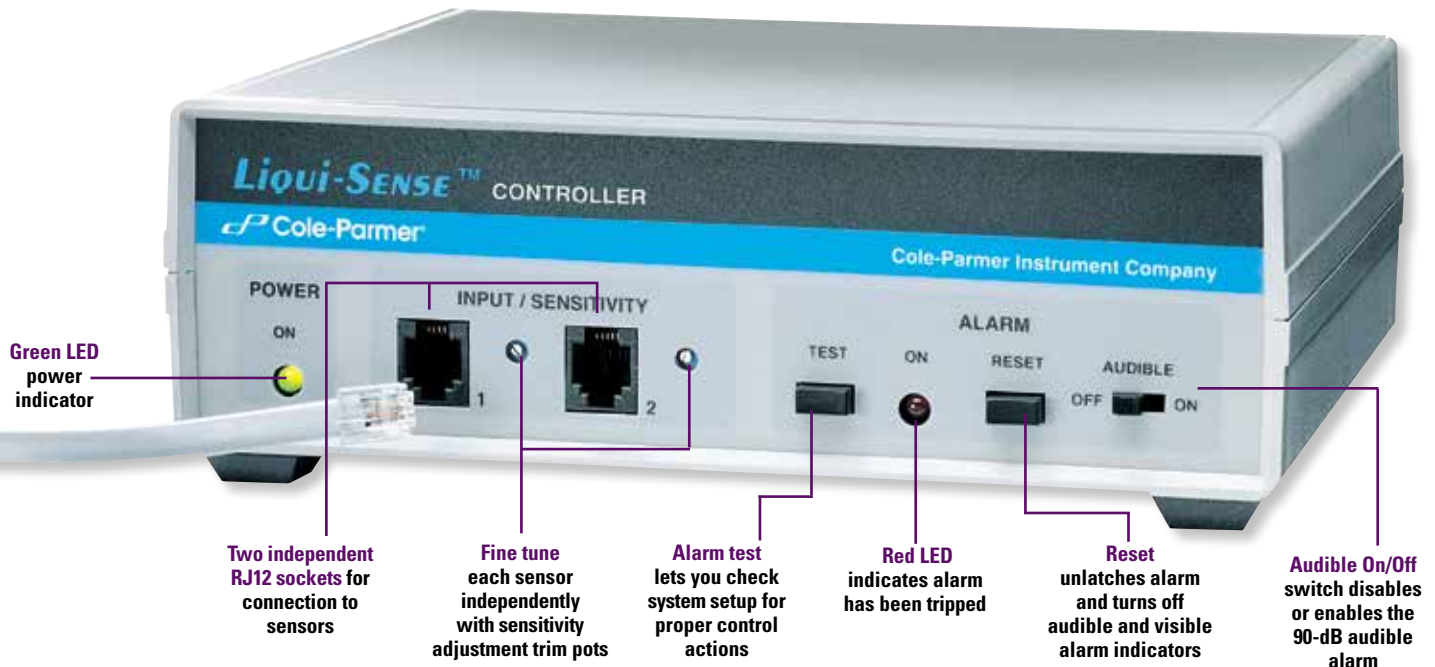

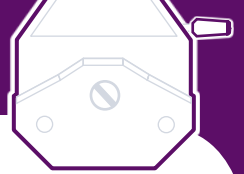

## 2a LIQUID DETECTOR PAD

- ▶ Capacitance sensor pad detects leaks
- ▶ Less than 1 mL of most fluids will trigger the alarm
- ▶ Virtually eliminates loss of costly fluid or damage from hazardous chemicals
- ▶ Factory calibrated for water—calibration adjustment required for other fluids
- ▶ Polyester pad wipes clean after spills
- ▶ Velcro® strip holds sensor pad in place
- ▶ Pad measurement: 12.7 cm L x 6.7 cm W (5" L x 2 5/8" W)
- ▶ Includes a 1-m (3 1/2-ft) shielded connecting cable. Order extension cables separately under "Accessories" below.



Liquid detector pad  
77095-00

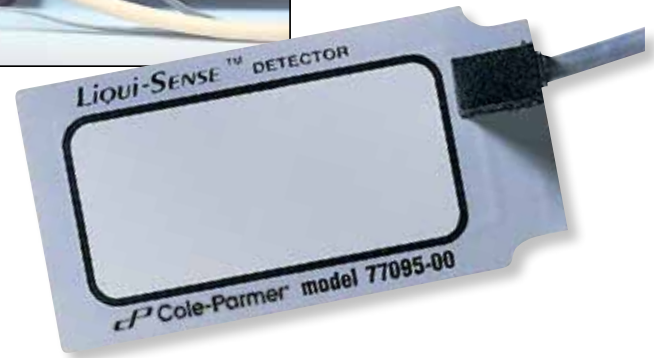

## ORDERING INFORMATION

Cat. no.	Description
<a href="#">HL-77095-00</a>	Liquid detector pad
<a href="#">HL-77095-02</a>	Replacement connecting cable 1-m (3 1/2-ft), RJ12 connections

## 2b FLOAT-SWITCH LEVEL SENSOR

- ▶ Fluid level monitored by placing sensor in either the fluid source or destination
- ▶ Sensor triggers alarm when fluid level changes
- ▶ Mounts in the side of tank through 1/2" NPT(F) bulkhead (not included)
- ▶ Hinged float-switch swings magnet into place to trip reed switch
- ▶ UL-recognized, CSA- and CE-certified
- ▶ 0.6-m (2-ft) two-wire sensor lead must be adapted to fit RJ12 socket on controller (use connecting cable 77095-02)



Float-switch  
level sensor  
07187-28

## ORDERING INFORMATION

Cat. no.	Description
<a href="#">HL-07187-28</a>	Polypropylene float switch; requires connecting cable 77095-02
<a href="#">HL-07187-30</a>	Nylon float switch; requires connecting cable 77095-02
<a href="#">HL-77095-02</a>	Connecting cable with RJ12 connectors, 1 m (3 1/2 ft)



## 3 ACCESSORIES

[HL-08330-20](#) **24-hour application monitor;** automatically dials phone or pager under alarm condition. Requires cable 23000-70

[HL-23000-70](#) **Interface cable** for monitor 08330-20

[HL-77095-03](#) **Extension cable**, 3.0-m (10-ft) with RJ12 connection for all sensors.

[HL-77095-04](#) **Extension cable**, 4.5-m (15-ft) with RJ12 connection for all sensors.

### FOR THE LATEST...

Masterflex technical resources, see

- ColeParmer.com
- Masterflex.com

## MASTERFLEX BARBED FITTINGS



**A**  
Straight barb



**B**  
Tee connector



**C**  
"Y" connector



**D**  
Barb x NPT(M) adapter



**E**  
Reducer barb

Size	Use with Masterflex tubing sizes			HDPE	Nylon	Polypropylene	Kynar® PVDF
	L/S®	I/P®	B/T®				
Catalog number (Pack of 10)							
<b>A Straight barbs</b>							
1/16"	13, 14	—	—	<a href="#">HL-30612-01</a>	<a href="#">HL-30612-02</a>	<a href="#">HL-30612-43</a>	<a href="#">HL-30612-04</a>
1/8"	16	—	—	<a href="#">HL-30612-05</a>	<a href="#">HL-30612-06</a>	<a href="#">HL-30612-47</a>	<a href="#">HL-30612-08</a>
3/16"	15, 25	—	—	<a href="#">HL-30612-09</a>	<a href="#">HL-30612-10</a>	<a href="#">HL-30612-51</a>	<a href="#">HL-30612-12</a>
1/4"	17, 24	26	—	<a href="#">HL-30612-13</a>	<a href="#">HL-30612-14</a>	<a href="#">HL-30612-55</a>	<a href="#">HL-30612-16</a>
3/8"	18, 35, 36	70, 73	—	<a href="#">HL-30612-17</a>	<a href="#">HL-30612-18</a>	<a href="#">HL-30612-59</a>	<a href="#">HL-30612-20</a>
1/2"	—	82, 88	87	<a href="#">HL-30612-21</a>	<a href="#">HL-30612-22</a>	<a href="#">HL-30612-63</a>	<a href="#">HL-30612-24</a>
5/8"	—	89	—	<a href="#">HL-30612-25</a>	<a href="#">HL-30612-26</a>	<a href="#">HL-30612-67</a>	<a href="#">HL-30612-28</a>
3/4"	—	—	91	<a href="#">HL-30612-29</a>	<a href="#">HL-30612-30</a>	<a href="#">HL-30612-71</a>	<a href="#">HL-30612-32</a>
<b>B Tee connectors (equal leg)</b>							
1/16"	13, 14	—	—	<a href="#">HL-30613-01</a>	<a href="#">HL-30613-02</a>	<a href="#">HL-30613-43</a>	<a href="#">HL-30613-04</a>
1/8"	16	—	—	<a href="#">HL-30613-05</a>	<a href="#">HL-30613-06</a>	<a href="#">HL-30613-47</a>	<a href="#">HL-30613-08</a>
3/16"	15, 25	—	—	<a href="#">HL-30613-09</a>	<a href="#">HL-30613-10</a>	<a href="#">HL-30613-51</a>	<a href="#">HL-30613-12</a>
1/4"	17, 24	26	—	<a href="#">HL-30613-13</a>	<a href="#">HL-30613-14</a>	<a href="#">HL-30613-55</a>	<a href="#">HL-30613-16</a>
3/8"	18, 35, 36	70, 73	—	<a href="#">HL-30613-17</a>	<a href="#">HL-30613-18</a>	<a href="#">HL-30613-59</a>	<a href="#">HL-30613-20</a>
1/2"	—	82, 88	87	<a href="#">HL-30613-21</a>	<a href="#">HL-30613-22</a>	<a href="#">HL-30613-63</a>	<a href="#">HL-30613-24</a>
5/8"	—	89	—	<a href="#">HL-30613-25</a>	<a href="#">HL-30613-26</a>	<a href="#">HL-30613-67</a>	<a href="#">HL-30613-28</a>
3/4"	—	—	91	<a href="#">HL-30613-29</a>	<a href="#">HL-30613-30</a>	<a href="#">HL-30613-71</a>	<a href="#">HL-30613-32</a>
<b>C Y-connectors (equal leg)</b>							
1/16"	13, 14	—	—	<a href="#">HL-30614-01</a>	<a href="#">HL-30614-02</a>	<a href="#">HL-30614-43</a>	<a href="#">HL-30614-04</a>
1/8"	16	—	—	<a href="#">HL-30614-05</a>	<a href="#">HL-30614-06</a>	<a href="#">HL-30614-47</a>	<a href="#">HL-30614-08</a>
3/16"	15, 25	—	—	<a href="#">HL-30614-09</a>	<a href="#">HL-30614-10</a>	<a href="#">HL-30614-51</a>	<a href="#">HL-30614-12</a>
1/4"	17, 24	26	—	<a href="#">HL-30614-13</a>	<a href="#">HL-30614-14</a>	<a href="#">HL-30614-55</a>	<a href="#">HL-30614-16</a>
3/8"	18, 35, 36	70, 73	—	<a href="#">HL-30614-17</a>	<a href="#">HL-30614-18</a>	<a href="#">HL-30614-59</a>	<a href="#">HL-30614-20</a>
1/2"	—	82, 88	87	<a href="#">HL-30614-21</a>	<a href="#">HL-30614-22</a>	<a href="#">HL-30614-63</a>	<a href="#">HL-30614-24</a>
5/8"	—	89	—	<a href="#">HL-30614-25</a>	<a href="#">HL-30614-26</a>	<a href="#">HL-30614-67</a>	<a href="#">HL-30614-28</a>
3/4"	—	—	91	<a href="#">HL-30614-29</a>	<a href="#">HL-30614-30</a>	<a href="#">HL-30614-71</a>	<a href="#">HL-30614-32</a>
<b>D Barb x NPT(M) adapters</b>							
1/8" x 1/8"	16	—	—	<a href="#">HL-30615-05</a>	<a href="#">HL-30615-06</a>	<a href="#">HL-30615-47</a>	<a href="#">HL-30615-08</a>
3/16" x 1/8"	15, 25	—	—	<a href="#">HL-30615-09</a>	<a href="#">HL-30615-10</a>	<a href="#">HL-30615-51</a>	<a href="#">HL-30615-12</a>
1/4" x 1/4"	17, 24	26	—	<a href="#">HL-30615-13</a>	<a href="#">HL-30615-14</a>	<a href="#">HL-30615-55</a>	<a href="#">HL-30615-16</a>
3/8" x 1/4"	18, 35, 36	70, 73	—	<a href="#">HL-30615-17</a>	<a href="#">HL-30615-18</a>	<a href="#">HL-30615-59</a>	<a href="#">HL-30615-20</a>
1/2" x 1/2"	—	82, 88	87	<a href="#">HL-30615-21</a>	<a href="#">HL-30615-22</a>	<a href="#">HL-30615-63</a>	<a href="#">HL-30615-24</a>
5/8" x 1/2"	—	89	—	<a href="#">HL-30615-25</a>	<a href="#">HL-30615-26</a>	<a href="#">HL-30615-67</a>	<a href="#">HL-30615-28</a>
3/4" x 1/2"	—	—	91	<a href="#">HL-30615-29</a>	<a href="#">HL-30615-30</a>	<a href="#">HL-30615-71</a>	<a href="#">HL-30615-32</a>
<b>E Reducer barbs</b>							
1/16" x 1/8"	13, 14	—	—	<a href="#">HL-30616-01</a>	<a href="#">HL-30616-02</a>	<a href="#">HL-30616-43</a>	<a href="#">HL-30616-04</a>
1/8" x 3/32"	16	—	—	<a href="#">HL-30616-05</a>	<a href="#">HL-30616-06</a>	<a href="#">HL-30616-47</a>	<a href="#">HL-30616-08</a>
3/16" x 1/8"	15, 25	—	—	<a href="#">HL-30616-09</a>	<a href="#">HL-30616-10</a>	<a href="#">HL-30616-51</a>	<a href="#">HL-30616-12</a>
1/4" x 1/8"	17, 24	26	—	<a href="#">HL-30616-13</a>	<a href="#">HL-30616-14</a>	<a href="#">HL-30616-55</a>	<a href="#">HL-30616-16</a>
3/8" x 1/4"	18, 35, 36	70, 73	—	<a href="#">HL-30616-17</a>	<a href="#">HL-30616-18</a>	<a href="#">HL-30616-59</a>	<a href="#">HL-30616-20</a>
1/2" x 3/8"	—	82, 88	87	<a href="#">HL-30616-21</a>	<a href="#">HL-30616-22</a>	<a href="#">HL-30616-63</a>	<a href="#">HL-30616-24</a>
5/8" x 1/2"	—	89	—	<a href="#">HL-30616-25</a>	<a href="#">HL-30616-26</a>	<a href="#">HL-30616-67</a>	<a href="#">HL-30616-28</a>
3/4" x 1/2"	—	—	91	<a href="#">HL-30616-29</a>	<a href="#">HL-30616-30</a>	<a href="#">HL-30616-71</a>	<a href="#">HL-30616-32</a>

## HANDHELD TUBING CUTTER

Steel blade coated with PTFE resin produces clean, straight cuts through any size of Masterflex® tubing (cuts polyethylene tubing up to 38.1 mm [1 1/2"] OD).



06438-90

Catalog number	Description
<a href="#">HL-06438-90</a>	Handheld tubing cutter

[HL-06438-81](#) Optional tubing cutter pouch.

[HL-06438-92](#) Replacement blade for 06438-90.

## BENCHTOP TUBING CUTTER

Steel blade makes right-angle cuts in several sizes of Masterflex tubing:

C/L®: 2.06 mm, 2.79 mm OD  
L/S®: sizes 13, 14, 15, 16, 17, 18, 24, 25, 35, 36  
I/P®: 26, 73



06438-10

Catalog number	Description
<a href="#">HL-06438-10</a>	Benchtop tubing cutter

[HL-06438-11](#) Replacement blade for 06438-10.

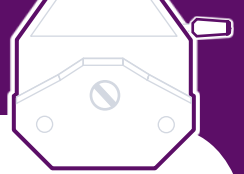

## MICROBORE TUBING CONNECTORS

Connect even the smallest tubing with a leak-free seal from vacuum to 34.5 bar (500 psi)

- Multiple styles to fit your need
- Stainless steel fitting is autoclavable
- Temperature range from -57 to 260°C (-70 to 500°F)

Catalog number	Gauge	Masterflex C/L® tubing size	Tubing size (mm)	
			ID	ID2
<b>A Straight connectors</b>				
<a href="#">HL-34001-01</a>	33	-10	0.19	—
<a href="#">HL-34001-02</a>	30	-12	0.25	—
<a href="#">HL-34001-03</a>	24	-18	0.51	—
<a href="#">HL-34001-04</a>	20	-26	0.89	—
<a href="#">HL-34001-05</a>	18	-30	1.14	—
<a href="#">HL-34001-06</a>	17	-34	1.42	—
<a href="#">HL-34001-07</a>	14	-42	2.06	—
<a href="#">HL-34001-08</a>	12	-48	2.79	—
<b>B Reducer connectors</b>				
<a href="#">HL-34001-11</a>	33 x 30	-10 x -12	0.19	0.25
<a href="#">HL-34001-12</a>	30 x 24	-12 x -18	0.25	0.51
<a href="#">HL-34001-13</a>	24 x 20	-18 x -26	0.51	0.89
<a href="#">HL-34001-14</a>	20 x 18	-26 x -30	0.89	1.14
<a href="#">HL-34001-15</a>	18 x 17	-30 x -34	1.14	1.42
<a href="#">HL-34001-16</a>	17 x 14	-34 x -42	1.42	2.06
<a href="#">HL-34001-17</a>	14 x 12	-42 x -48	2.06	2.79
<a href="#">HL-34001-18</a>	12 x 1/8" barb	-48 x 1/8" ID	2.79	3.18
<a href="#">HL-34001-21</a>	33 x 24	-10 x -18	0.19	0.51
<a href="#">HL-34001-22</a>	30 x 20	-12 x -26	0.25	0.89
<a href="#">HL-34001-23</a>	24 x 18	-18 x -30	0.51	1.14
<a href="#">HL-34001-24</a>	20 x 17	-26 x -34	0.89	1.42
<a href="#">HL-34001-25</a>	18 x 14	-30 x -42	1.14	2.06
<a href="#">HL-34001-26</a>	17 x 12	-34 x -48	1.42	2.79
<a href="#">HL-34001-27</a>	14 x 1/8" barb	-42 x 1/8" ID	2.06	3.18
<a href="#">HL-34001-28</a>	12 x 3/16" barb	-48 x 3/16" ID	2.79	4.76
<b>C "Y" connectors</b>				
<a href="#">HL-34001-31</a>	33	-10	0.19	—
<a href="#">HL-34001-32</a>	30	-12	0.25	—
<a href="#">HL-34001-33</a>	24	-18	0.51	—
<a href="#">HL-34001-34</a>	20	-26	0.89	—
<a href="#">HL-34001-35</a>	18	-30	1.14	—
<a href="#">HL-34001-36</a>	17	-34	1.42	—
<a href="#">HL-34001-37</a>	14	-42	2.06	—
<a href="#">HL-34001-38</a>	12	-48	2.79	—



**A**  
Straight connector



**B**  
Reducer connector



**C**  
"Y" connector

## Cole-Parmer® ANIMAL-FREE LUER FITTINGS

Manufactured of animal-free natural polypropylene, these luer fittings meet USP Class VI specifications. Fittings offer superior chemical resistance and are suited for ETO and gamma sterilization (not recommended for autoclaving). Sold in packs of 25.

ANIMAL DERIVED  
INGREDIENT FREE



30800-10

Description	Masterflex® tubing size	Catalog number
<b>Female luer x hose barb adapters (wide bore)</b>		
Female luer x 1/8" hose barb	L/S® 16	<a href="#">HL-30800-02</a>
Female luer x 3/16" hose barb	L/S 15, 25	<a href="#">HL-30800-04</a>
Female luer x 1/4" barb	L/S 17, 24	<a href="#">HL-30800-06</a>
<b>Female luer x hose barb adapters (high pressure)</b>		
Female luer x 1/8" hose barb	L/S 16	<a href="#">HL-30800-08</a>
<b>Female luer x hose barb adapters (standard)</b>		
Female luer x 1/4" barb	L/S 17, 24	<a href="#">HL-30800-10</a>
<b>Male luer lock x hose barb adapters (wide bore)</b>		
Male luer x 1/8" hose barb	L/S 13, 14	<a href="#">HL-30800-16</a>
Male luer x 1/8" hose barb	L/S 16	<a href="#">HL-30800-18</a>
Male luer x 3/16" hose barb	L/S 15, 25	<a href="#">HL-30800-20</a>
Male luer x 1/4" barb	L/S 17, 24	<a href="#">HL-30800-22</a>
<b>Male luer x hose barb adapters (high pressure)</b>		
Male luer x 1/8" hose barb	L/S 16	<a href="#">HL-30800-24</a>
<b>Male luer x hose barb adapters (standard)</b>		
Male luer x 1/4" hose barb	L/S 17, 24	<a href="#">HL-30800-26</a>
<b>Male luer adapters</b>		
Male luer x male luer	—	<a href="#">HL-30800-14</a>
Male luer lock plug	—	<a href="#">HL-30800-30</a>

## QUICK-DISCONNECT COUPLINGS

### Available in acetal or polypropylene (PP) construction

For each complete quick-disconnect fitting, order one body and one insert with the same flow size. Plug insert into body to connect fitting—fitting halves lock in place immediately.

To disconnect fitting halves, simply press the lever on the coupling body; a spring-operated valve in each fitting half seals the flow path. ("Straight-through" fittings without shutoff valves are also available.) All fitting bodies have 316 stainless steel springs and latches.



**A**  
Hose barb body



**B**  
Panel-mount hose barb body



**C**  
Hose barb insert



**D**  
Panel-mount hose barb insert

### SPECIFICATIONS

Body material	Acetal	Polypropylene
Seal material	Buna N	EPR
Max pressure at 21°C (70°F)	8.3 bar (120 psi)	6.9 bar (100 psi)
Max vacuum	718 mm Hg (28" Hg)	718 mm Hg (28" Hg)
Max temp	82°C (180°F)	71°C (160°F)
Sterilization	Autoclave or ETO	Gamma or ETO

### A Hose Barb Bodies

Use with Masterflex® sizes		Catalog number	Flow size	Length (mm)	Resin
L/S®	I/P®				
<b>Valved fittings</b>					
13, 14	—	<a href="#">HL-06360-19</a>	1/8"	35.8	Acetal
16	—	<a href="#">HL-06360-20</a>	1/8"	41.9	Acetal
15, 25	—	<a href="#">HL-06360-22</a>	1/8"	47.0	Acetal
17, 24	26	<a href="#">HL-06360-25</a>	1/8"	47.0	Acetal
17, 24	26	<a href="#">HL-06360-65</a>	1/4"	49.5	Acetal
18, 35, 36	70, 73	<a href="#">HL-06360-70</a>	1/4"	49.5	Acetal
13, 14	—	<a href="#">HL-06364-19</a>	1/8"	35.8	PP
16	—	<a href="#">HL-06364-20</a>	1/8"	42.4	PP
17, 24	26	<a href="#">HL-06364-25</a>	1/8"	47.5	PP
17, 24	26	<a href="#">HL-06364-65</a>	1/4"	50.0	PP
18, 35, 36	70, 73	<a href="#">HL-06364-70</a>	1/4"	50.0	PP
<b>Straight-through fittings</b>					
13, 14	—	<a href="#">HL-06361-09</a>	1/8"	35.8	Acetal
16	—	<a href="#">HL-06361-11</a>	1/8"	41.9	Acetal
15, 25	—	<a href="#">HL-06361-12</a>	1/8"	47.0	Acetal
17, 24	26	<a href="#">HL-06361-13</a>	1/8"	47.0	Acetal
17, 24	26	<a href="#">HL-06361-51</a>	1/4"	49.5	Acetal
18, 35, 36	70, 73	<a href="#">HL-06361-53</a>	1/4"	49.5	Acetal

### B Panel-Mount Hose Barb Bodies

Use with Masterflex sizes		Catalog number	Flow size	Thread	Resin
L/S	I/P				
<b>Valved fittings</b>					
13, 14	—	<a href="#">HL-06360-09</a>	1/8"	1/2" - 24	Acetal
16	—	<a href="#">HL-06360-10</a>	1/8"	1/2" - 24	Acetal
15, 25	—	<a href="#">HL-06360-12</a>	1/8"	1/2" - 24	Acetal
17, 24	26	<a href="#">HL-06360-15</a>	1/8"	1/2" - 24	Acetal
17, 24	26	<a href="#">HL-06360-55</a>	1/4"	1 1/16" - 24	Acetal
18, 35, 36	70, 73	<a href="#">HL-06360-60</a>	1/4"	1 1/16" - 24	Acetal
13, 14	—	<a href="#">HL-06364-09</a>	1/8"	1/2" - 24	PP
16	—	<a href="#">HL-06364-10</a>	1/8"	1/2" - 24	PP
17, 24	26	<a href="#">HL-06364-15</a>	1/8"	1/2" - 24	PP
17, 24	26	<a href="#">HL-06364-55</a>	1/4"	1 1/16" - 24	PP
18, 35, 36	70, 73	<a href="#">HL-06364-60</a>	1/4"	1 1/16" - 24	PP
<b>Straight-through fittings</b>					
13, 14	—	<a href="#">HL-06361-03</a>	1/8"	1/2" - 24	Acetal
16	—	<a href="#">HL-06361-04</a>	1/8"	1/2" - 24	Acetal
15, 25	—	<a href="#">HL-06361-05</a>	1/8"	1/2" - 24	Acetal
17, 24	26	<a href="#">HL-06361-06</a>	1/8"	1/2" - 24	Acetal
17, 24	26	<a href="#">HL-06361-46</a>	1/4"	1 1/16" - 24	Acetal
18, 35, 36	70, 73	<a href="#">HL-06361-48</a>	1/4"	1 1/16" - 24	Acetal

### C Hose Barb Inserts

Use with Masterflex sizes		Catalog number	Flow size	Length (mm)	Resin
L/S	I/P				
<b>Valved fittings</b>					
13, 14	—	<a href="#">HL-06360-36</a>	1/8"	34.3	Acetal
16	—	<a href="#">HL-06360-40</a>	1/8"	39.4	Acetal
15, 25	—	<a href="#">HL-06360-43</a>	1/8"	44.5	Acetal
17, 24	26	<a href="#">HL-06360-45</a>	1/8"	40.1	Acetal
17, 24	26	<a href="#">HL-06360-80</a>	1/4"	47.2	Acetal
18, 35, 36	70, 73	<a href="#">HL-06360-85</a>	1/4"	42.7	Acetal
13, 14	—	<a href="#">HL-06364-38</a>	1/8"	34.3	PP
16	—	<a href="#">HL-06364-40</a>	1/8"	39.4	PP
17, 24	26	<a href="#">HL-06364-45</a>	1/8"	40.1	PP
17, 24	26	<a href="#">HL-06364-80</a>	1/4"	47.2	PP
18, 35, 36	70, 73	<a href="#">HL-06364-85</a>	1/4"	42.4	PP
<b>Straight-through fittings</b>					
13, 14	—	<a href="#">HL-06360-38</a>	1/8"	20.3	Acetal
16	—	<a href="#">HL-06360-42</a>	1/8"	26.7	Acetal
15, 25	—	<a href="#">HL-06360-44</a>	1/8"	31.8	Acetal
17, 24	26	<a href="#">HL-06360-47</a>	1/8"	34.3	Acetal
17, 24	26	<a href="#">HL-06360-82</a>	1/4"	34.3	Acetal
18, 35, 36	70, 73	<a href="#">HL-06360-87</a>	1/4"	34.3	Acetal
13, 14	—	<a href="#">HL-06364-39</a>	1/8"	20.3	PP
16	—	<a href="#">HL-06364-42</a>	1/8"	26.7	PP
17, 24	26	<a href="#">HL-06364-47</a>	1/8"	31.8	PP
17, 24	26	<a href="#">HL-06364-82</a>	1/4"	34.3	PP
18, 35, 36	70, 73	<a href="#">HL-06364-87</a>	1/4"	34.3	PP

### D Panel-Mount Hose Barb Inserts

Use with Masterflex sizes		Catalog number	Flow size	Length (mm)	Resin
L/S	I/P				
<b>Valved fittings</b>					
13, 14	—	<a href="#">HL-06361-33</a>	1/8"	35.1	Acetal
16	—	<a href="#">HL-06361-34</a>	1/8"	41.4	Acetal
15, 25	—	<a href="#">HL-06361-35</a>	1/8"	46.5	Acetal
17, 24	26	<a href="#">HL-06361-36</a>	1/8"	46.5	Acetal
17, 24	26	<a href="#">HL-06361-71</a>	1/4"	48.5	Acetal
18, 35, 36	70, 73	<a href="#">HL-06361-73</a>	1/4"	48.5	Acetal
17, 24	26	<a href="#">HL-06361-92</a>	1/4"	48.5	PP
18, 35, 36	70, 73	<a href="#">HL-06361-93</a>	1/4"	48.5	PP
<b>Straight-through fittings</b>					
13, 14	—	<a href="#">HL-06361-21</a>	1/8"	35.1	Acetal
16	—	<a href="#">HL-06361-22</a>	1/8"	41.4	Acetal
15, 25	—	<a href="#">HL-06361-23</a>	1/8"	46.5	Acetal
17, 24	26	<a href="#">HL-06361-24</a>	1/8"	46.5	Acetal
17, 24	26	<a href="#">HL-06361-58</a>	1/4"	48.5	Acetal
18, 35, 36	70, 73	<a href="#">HL-06361-61</a>	1/4"	48.5	Acetal
17, 24	26	<a href="#">HL-06361-82</a>	1/4"	48.5	PP
18, 35, 36	70, 73	<a href="#">HL-06361-83</a>	1/4"	48.5	PP

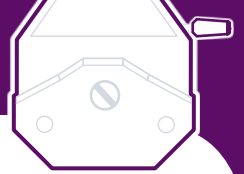

## MINIATURE QUICK-DISCONNECT COUPLINGS

These fittings offer a secure connection and are completely interchangeable. Fittings halves engage and seal with a twist. Once engaged, the coupling allows the tubing to rotate freely to help prevent kinked tubing and accidental disconnections.

For a complete coupling, order one fitting body and one insert.

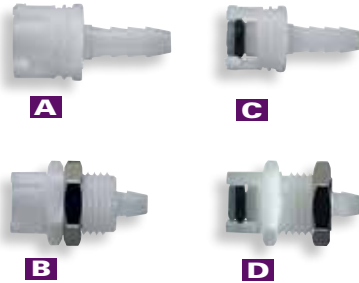

### SPECIFICATIONS

Body material	Acetal	Polypropylene (PP)
Color	Natural white	Almond
Locking sleeve	Acetal	Acetal
Valve	Acetal	Acetal
Valve spring	316 SS	316 SS
O-ring	Buna N	EPDM
Temperature range	-40 to 82°C (-40 to 180°F)	0 to 82°C (32 to 180°F)

### A Hose Barb Bodies

Use with Masterflex® sizes		Catalog number	Length (mm)	Resin
C/L® (tube ID, mm)	L/S®			
<b>Valved bodies</b>				
1.14, 1.42	13, 14	<a href="#">HL-06363-55</a>	22.9	Acetal
2.06, 2.79	16, 25	<a href="#">HL-06363-57</a>	22.9	Acetal
<b>Straight-through bodies</b>				
1.14, 1.42	13, 14	<a href="#">HL-06363-54</a>	19.1	Acetal
2.06, 2.79	16, 25	<a href="#">HL-06363-56</a>	22.9	Acetal
1.14, 1.42	13, 14	<a href="#">HL-06363-62</a>	19.1	PP
2.06, 2.79	16, 25	<a href="#">HL-06363-64</a>	22.9	PP

### B Panel-Mount Hose Barb Bodies

Use with Masterflex sizes		Catalog number	Length (mm)	Resin
C/L (tube ID, mm)	L/S			
<b>Valved bodies</b>				
1.14, 1.42	13, 14	<a href="#">HL-06363-67</a>	22.9	Acetal
2.06, 2.79	16, 25	<a href="#">HL-06363-69</a>	22.9	Acetal
<b>Straight-through bodies</b>				
1.14, 1.42	13, 14	<a href="#">HL-06363-66</a>	19.1	Acetal
2.06, 2.79	16, 25	<a href="#">HL-06363-78</a>	22.9	Acetal
1.14, 1.42	13, 14	<a href="#">HL-06363-76</a>	19.1	PP

### C Hose Barb Inserts

Use with Masterflex sizes		Catalog number	Length (mm)	Resin
C/L (tube ID, mm)	L/S			
<b>Straight-through inserts</b>				
1.14, 1.42	13, 14	<a href="#">HL-06363-50</a>	19.1	Acetal
2.06, 2.79	16, 25	<a href="#">HL-06363-52</a>	22.9	Acetal
1.14, 1.42	13, 14	<a href="#">HL-06363-58</a>	19.1	PP
2.06, 2.79	16, 25	<a href="#">HL-06363-60</a>	22.9	PP

### D Panel-Mount Hose Barb Inserts

Use with Masterflex sizes		Catalog number	Length (mm)	Resin
C/L (tube ID, mm)	L/S			
<b>Straight-through inserts</b>				
1.14, 1.42	13, 14	<a href="#">HL-06363-70</a>	19.1	Acetal
2.06, 2.79	16, 25	<a href="#">HL-06363-72</a>	22.9	Acetal
1.14, 1.42	13, 14	<a href="#">HL-06363-80</a>	19.1	PP
2.06, 2.79	16, 25	<a href="#">HL-06363-82</a>	22.9	PP

## HIGH-FLOW QUICK-DISCONNECT COUPLINGS

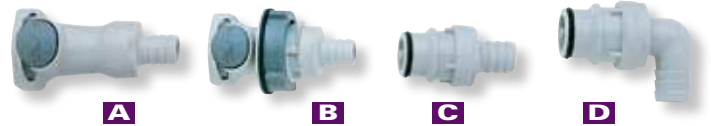

Plug insert into coupling body to connect—fitting halves lock into place immediately. To disconnect fitting halves, simply press the button on the coupling body. Valved models have a spring-operated 316 SS valve that seals the flow path when fitting halves are disengaged.

### SPECIFICATIONS

Body material	Polypropylene	Polysulfone
Temperature range	0 to 71°C (32 to 160°F)	-40 to 137°C (-40 to 280°F)
Max pressure	4.1 bar (60 psi)	8.6 bar (125 psi)
Max vacuum	699 mm Hg (27.5" Hg)	
Sterilization	Gamma or ETO	Autoclave, gamma, or ETO

### A Hose Barb Bodies

Use with Masterflex® sizes			Polypropylene	Polysulfone
L/S®	I/P®	B/T®	Catalog number	
<b>Valved bodies</b>				
18, 36	70, 73	—	<a href="#">HL-31303-10</a>	<a href="#">HL-31307-10</a>
—	82, 88	87	<a href="#">HL-31303-11</a>	<a href="#">HL-31307-11</a>
—	89	—	<a href="#">HL-31303-12</a>	<a href="#">HL-31307-12</a>
—	—	91	<a href="#">HL-31303-13</a>	<a href="#">HL-31307-13</a>
<b>Straight-through bodies</b>				
18, 36	70, 73	—	<a href="#">HL-31303-15</a>	<a href="#">HL-31307-15</a>
—	82, 88	87	<a href="#">HL-31303-16</a>	<a href="#">HL-31307-16</a>
—	89	—	<a href="#">HL-31303-17</a>	<a href="#">HL-31307-17</a>
—	—	91	<a href="#">HL-31303-18</a>	<a href="#">HL-31307-18</a>

### B Bulkhead Panel-Mount Hose Barb Bodies

Use with Masterflex sizes			Polypropylene	Polysulfone
L/S	I/P	B/T	Catalog number	
<b>Valved bodies</b>				
18, 36	70, 73	—	<a href="#">HL-31303-20</a>	<a href="#">HL-31307-20</a>
—	82, 88	87	<a href="#">HL-31303-21</a>	<a href="#">HL-31307-21</a>
—	89	—	<a href="#">HL-31303-22</a>	<a href="#">HL-31307-22</a>
—	—	91	<a href="#">HL-31303-23</a>	<a href="#">HL-31307-23</a>
<b>Straight-through bodies</b>				
18, 36	70, 73	—	<a href="#">HL-31303-25</a>	<a href="#">HL-31307-25</a>
—	82, 88	87	<a href="#">HL-31303-26</a>	<a href="#">HL-31307-26</a>
—	89	—	<a href="#">HL-31303-27</a>	<a href="#">HL-31307-27</a>
—	—	91	<a href="#">HL-31303-28</a>	<a href="#">HL-31307-28</a>

### C Hose Barb Inserts

Use with Masterflex sizes			Polypropylene	Polysulfone
L/S	I/P	B/T	Catalog number	
<b>Valved inserts</b>				
18, 36	70, 73	—	<a href="#">HL-31303-45</a>	<a href="#">HL-31307-45</a>
—	82, 88	87	<a href="#">HL-31303-46</a>	<a href="#">HL-31307-46</a>
—	89	—	<a href="#">HL-31303-47</a>	<a href="#">HL-31307-47</a>
—	—	91	<a href="#">HL-31303-48</a>	<a href="#">HL-31307-48</a>
<b>Straight-through inserts</b>				
18, 36	70, 73	—	<a href="#">HL-31303-40</a>	<a href="#">HL-31307-40</a>
—	82, 88	87	<a href="#">HL-31303-41</a>	<a href="#">HL-31307-41</a>
—	89	—	<a href="#">HL-31303-42</a>	<a href="#">HL-31307-42</a>
—	—	91	<a href="#">HL-31303-43</a>	<a href="#">HL-31307-43</a>

### D Elbow Hose Barb Inserts

Use with Masterflex sizes			Polypropylene	Polysulfone
L/S	I/P	B/T	Catalog number	
<b>Valved inserts</b>				
18, 36	70, 73	—	<a href="#">HL-31303-55</a>	<a href="#">HL-31307-55</a>
—	82, 88	87	<a href="#">HL-31303-56</a>	<a href="#">HL-31307-56</a>
<b>Straight-through inserts</b>				
18, 36	70, 73	—	<a href="#">HL-31303-50</a>	<a href="#">HL-31307-50</a>
—	82, 88	87	<a href="#">HL-31303-51</a>	<a href="#">HL-31307-51</a>

## BARBLOCK™ ULTRA-SECURE TUBING RETAINERS

### Uniform 360° compression for leak-free connection to barbed fittings

- ▶ Easy to install—ensures that tubing and fitting will not disengage
- ▶ Provides seven times the pull resistance of cable ties without crimps or distortion
- ▶ Compatible with single- or multi-tiered barbed fittings

BarbLock assemblies provide uniform 360° mechanical compression for a leak-free, durable seal, unlike cable ties or clamps. Fitting will not leak or blow off. Ideal for filtration, since retainer holds tight even with increasing back pressure as filter clogs.

To install the fitting, slide the sleeve and collet onto the tubing and then insert the barbed fitting into the tubing. Slide the sleeve and collet to the edge of the barbed fitting and lock with the BarbLock assembly tool. Once assembled, the BarbLock assembly can only be unlocked with the universal removal tool (order at right).

BarbLock assemblies meet USP Class VI standards. Sterilize by radiation, steam, or ethylene oxide (ETO) gas. Pack of 1 each.



BarbLock retainer tool 30604-12

BarbLock retainer 30604-04

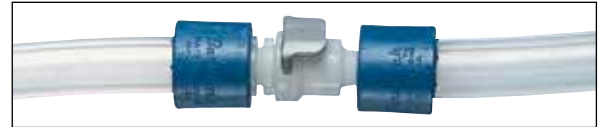

Platinum-cured silicone tubing 96410-73 shown with BarbLock retainer 30604-04 and quick-disconnect fitting 06360-91.

### ORDERING INFORMATION for Tubing Retainers

Catalog number	Use with Masterflex® pump tubing size	Use with fitting type
<a href="#">HL-30604-01</a>	L/S® 16	Any barbed fitting
<a href="#">HL-30604-00</a>	L/S 17 and L/S 15	
<a href="#">HL-30604-02</a>	L/S 24	
<a href="#">HL-30604-04</a>	I/P® 73	
<a href="#">HL-30604-06</a>	I/P 82 and I/P 70	
<a href="#">HL-30604-08</a>	I/P 82 and I/P 70	Quick-disconnects only (see pages 164–165)

### ORDERING INFORMATION for Retainer Tools

Catalog number	BarbLock assembly tool for use with
<a href="#">HL-30604-18</a>	L/S 16 tubing
<a href="#">HL-30604-10</a>	L/S 15, L/S 17, and L/S 24 tubing
<a href="#">HL-30604-12</a>	I/P 73 tubing
<a href="#">HL-30604-14</a>	I/P 82 tubing
<a href="#">HL-30604-16</a>	Universal BarbLock removal tool

## SOLENOID TWO-WAY PINCH VALVES

### Specifically designed to work with Masterflex® pump tubing

- ▶ Use with tubing that has durometer rating of 50 or less such as C-FLEX® or silicone—0.5 bar (7.25 psi) max
- ▶ Excellent for clean processes—fluid stays contained within tubing
- ▶ Use for on/off flow control applications



98306-16

98306-02

Tube size	Response time	Watts	12 VDC valves	24 VDC valves
			Catalog number	Catalog number
<b>Normally closed</b>				
L/S 14	30 to 50 msec	10	<a href="#">HL-98306-00</a>	<a href="#">HL-98306-02</a>
L/S 16			<a href="#">HL-98306-08</a>	<a href="#">HL-98306-10</a>
L/S 25			<a href="#">HL-98306-16</a>	<a href="#">HL-98306-18</a>
L/S 17			<a href="#">HL-98306-24</a>	<a href="#">HL-98306-26</a>
<b>Normally open</b>				
L/S 14	30 to 50 msec	10	<a href="#">HL-98306-04</a>	<a href="#">HL-98306-06</a>
L/S 16			<a href="#">HL-98306-12</a>	<a href="#">HL-98306-14</a>
L/S 25			<a href="#">HL-98306-20</a>	<a href="#">HL-98306-22</a>
L/S 17			<a href="#">HL-98306-28</a>	<a href="#">HL-98306-30</a>

## CLAMPS FOR HOSE BARB FITTINGS

### Plastic Clamps

Lightweight, reusable. Rust- and corrosion-resistant acetal copolymer. Temperature range: 0 to 93°C (32 to 200°F).



06832-06

### Stainless Steel Clamps

Rugged, reusable, wide temperature range. Corrosion-resistant 300-series 1.3-cm (1/2") wide band. Screw adjusts with slotted screwdriver.



06403-11

Use with Masterflex® tubing size	Plastic		Stainless steel	
	Cat. no.	Qty/pk	Cat. no.	Qty/pk
L/S 16	<a href="#">HL-06832-01</a>	100	<a href="#">HL-06403-11</a>	10
L/S 25	<a href="#">HL-06832-03</a>			
L/S 15, L/S 17	<a href="#">HL-06832-02</a>			
L/S 24, 18, 35; I/P 26	<a href="#">HL-06832-06</a>			
L/S 36	<a href="#">HL-06832-08</a>	100	<a href="#">HL-06403-12</a>	10
I/P 73	<a href="#">HL-06832-10</a>			
I/P 70	<a href="#">HL-06832-14</a>			
I/P 82	<a href="#">HL-06832-16</a>			
I/P 88	<a href="#">HL-06832-20</a>			
I/P 89; B/T® 87	<a href="#">HL-06832-22</a>	50	<a href="#">HL-06403-13</a>	10
B/T 91	<a href="#">HL-06832-34</a>			



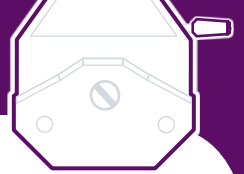

## PURE-FIT® TC TUBING CLAMPS

Install easily over existing tubing lines or assemblies

- ▶ Smooth contours eliminate risk of puncture or rupture
- ▶ Fully sterilizable
- ▶ Meet USP Class IV criteria



The Pure-Fit TC clamp has a press-down locking mechanism that provides complete fluid stoppage. Its side-release mechanism ensures against unwanted opening. The open design can be installed over existing fittings or finished tubing assemblies, eliminating costly downtime. Available sizes handle two tubing ranges.

Available in polypropylene (PP) or PVDF. Sterilize PP by gamma irradiation only; PVDF may be sterilized by gamma irradiation or autoclaving. Sold in pack of 10.

Catalog number	Fits Masterflex® tubing sizes	Material
<a href="#">HL-06822-01</a>	L/S® 13, 14, 15, 16, 17, 25	Polypropylene
<a href="#">HL-06822-03</a>		PVDF
<a href="#">HL-06822-11</a>	L/S 18, 24, 35, 36; I/P® 26, 70, 73, 82	Polypropylene
<a href="#">HL-06822-13</a>		PVDF

## PURE-FIT® TRU VALVE

Easy to implement with installed assemblies and systems

- ▶ Reusable for multiple cycles and applications

With the Pure-Fit Tru valve, you no longer need to worry about a time-consuming retrofit to your system. The valve's butterfly design allows easy installation to existing lines; purity is maintained because the valve goes around the exterior of the tubing and never comes in contact with process fluid.

Simple threaded handle and calibrated scale ensure accurate control of flow and can also be written into validation protocols. The valve also features lockout positioning for use in steam-in-place (SIP) cycles. Its lightweight borosilicate glass-reinforced nylon construction reduces stress on your tubing line due to weight imbalance but is sturdy enough to withstand autoclaving or gamma irradiation. Accommodates any flexible tubing up to 17.8 mm (0.700") in outer diameter.



20002-00

Catalog number	Fits Masterflex® tubing sizes	Material
<a href="#">HL-20002-00</a>	L/S® 13, 14, 15, 16, 17, 18, 24, 25, 35, 36; I/P® 26, 73	Glass-reinforced nylon

## TUBING WEIGHTS

Flow-through weights of PTFE keep tubing in place in receiving vessel during dispense cycles. Fit Masterflex L/S tubing sizes noted.



Catalog number	Description
<a href="#">HL-78226-81</a>	Weight for L/S 16, 15, and 25
<a href="#">HL-78226-82</a>	Weight for L/S 17, 18, 24, 35, 36
<a href="#">HL-77310-03</a>	Set of two; one each of 78226-81 and 78226-82



## FILLER/DISPENSING

### NOZZLES

Maximize the speed, precision, and accuracy of dispensing and filling applications

- ▶ Minimize splashing and dripping when dispensing into narrow- or wide-mouth containers
- ▶ Dimensional tolerances of ±0.05% for assured repeatability

These nozzles combine the ease of plastic components with the accuracy and reliability of stainless steel filler needles. Tight dimensional tolerances help to ensure precision in your dispensing applications. Nozzles feature a 316L stainless steel tube and a polycarbonate base with hose barb adapter. Compliant with FDA, USDA and USP Class VI requirements. All filler nozzles are sterilizable by ethylene oxide, autoclaving, or gamma irradiation.



30619-02

Catalog number	Fits tubing ID	Fits Masterflex® tubing sizes
<a href="#">HL-30619-06</a>	1/32"	L/S® 13
<a href="#">HL-30619-01</a>	1/16"	L/S 14
<a href="#">HL-30619-07</a>	1/8"	L/S 16
<a href="#">HL-30619-02</a>	3/16"	L/S 15, 25
<a href="#">HL-30619-08</a>	1/4"	L/S 17, 24; I/P® 26
<a href="#">HL-30619-03</a>	5/16"	L/S 35
<a href="#">HL-30619-09</a>	3/8"	L/S 18, 36; I/P 70, 73; B/T® 86
<a href="#">HL-30619-04</a>	1/2"	I/P 82, 88; B/T 87
<a href="#">HL-30619-10</a>	5/8"	I/P 89
<a href="#">HL-30619-05</a>	3/4"	B/T 91

## TUBING RACKS

An easy solution to secure and route multiple tubing lines



Tubing rack 06432-04



Some racks separate easily for more convenient, customized tubing retainers.

These tube racks offer a simple and economical method for organizing your tubing lines. Tubing racks 06432-02, -03, and -07 can be easily separated down to single holders by hand for increased flexibility and custom tubing arrangements. Some sizes are available with adhesive fastener, and all sizes are available with through holes for secure mounting (mounting screws are not included). Sold in pack of 10.

Catalog number	Tubing size	Fastener	No. of channels
<a href="#">HL-06432-02</a>	L/S 14	Through holes	10
<a href="#">HL-06432-07</a>		Adhesive	10
<a href="#">HL-06432-03</a>	L/S 13, 16, 25	Through holes	10
<a href="#">HL-06432-08</a>		Adhesive	10
<a href="#">HL-06432-04</a>	L/S 15, 17, 18, 24, 36	Through holes	7
<a href="#">HL-06432-05</a>	L/S 35; I/P 26	Through holes	5

## REPLACEMENT PARTS FOR L/S® AND IP®

### L/S STANDARD PUMP HEAD PARTS

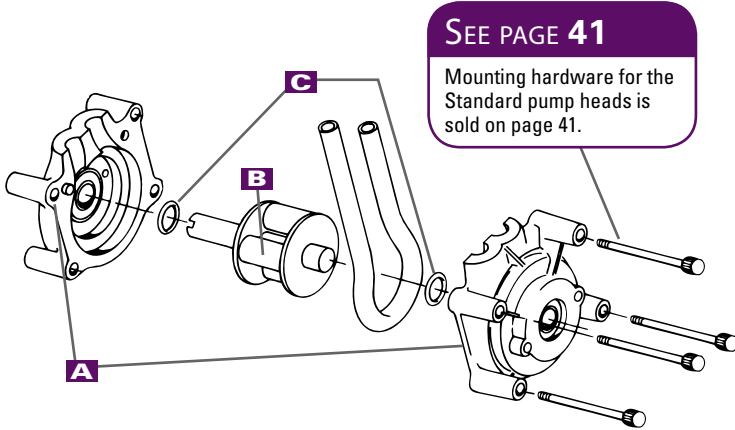

**A End Bell Assemblies.** Two required for a complete head assembly.

For pump heads with CRS rollers		For pump heads with SS rollers	
For pump heads	Catalog number	For pump heads	Catalog number
07013-20	<a href="#">HL-07013-81</a>	07013-21	<a href="#">HL-07013-91</a>
07014-20	<a href="#">HL-07014-81</a>	07014-21	<a href="#">HL-07014-91</a>
07015-20	<a href="#">HL-07015-81</a>	07015-21	<a href="#">HL-07015-91</a>
07016-20	<a href="#">HL-07016-81</a>	07016-21	<a href="#">HL-07016-91</a>
07017-20	<a href="#">HL-07017-81</a>	07017-21	<a href="#">HL-07017-91</a>
07018-20	<a href="#">HL-07018-81</a>	07018-21	<a href="#">HL-07018-91</a>
07024-20	<a href="#">HL-07024-81</a>	07024-21	<a href="#">HL-07024-91</a>
—	—	07035-21	<a href="#">HL-07035-91</a>

**B Rotor Assemblies.** Cold-rolled steel (CRS) or stainless steel (SS).

For pump heads with CRS rollers		For pump heads with SS rollers	
For models	Catalog number	For models	Catalog number
07013-20, -42	<a href="#">HL-07013-80</a>	07013-21, -52	<a href="#">HL-07013-95</a>
07014-20, -42		07014-21, -52	
07016-20, -42		07016-21, -52	
07017-20, -42		07017-21, -52	
07018-20, -42		07018-21, -52	
07015-20, -42	<a href="#">HL-07015-80</a>	07015-21, -52	<a href="#">HL-07015-90</a>
07024-20, -42		07024-21, -52	
07035-20		07035-21	

**C Thrust Washers**

Catalog number	Description
<a href="#">HL-07021-04</a>	Thrust washers

[HL-07019-90](#) L/S tubing loading key for Standard pump heads

## PUMP HEADS

### L/S EASY-LOAD® PUMP HEAD PARTS

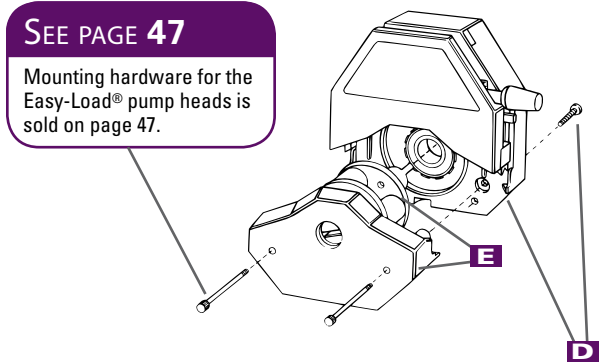

**D-E Main Body and Rotor/Bearing Assemblies**

For pump heads	Body/bearing material <sup>†</sup>	Catalog number
<b>D Main body assemblies.</b> Occlusion bed with rear bearings and screws.		
07518-00, -02, -20, -22	PSF/CRS	<a href="#">HL-07518-07</a>
07518-10, -12, -30, -32	PSF/SS	<a href="#">HL-07518-17</a>
07518-60, -62, -80, -82	PPS/SS	<a href="#">HL-07518-67</a>
<b>E Rotor/bearing support assemblies</b>		
07518-00	PSF/CRS	<a href="#">HL-07518-08</a>
07518-10	PSF/SS	<a href="#">HL-07518-18</a>
07518-02, -12	PSF/SS	<a href="#">HL-07518-19</a>
07518-60	PPS/SS	<a href="#">HL-07518-68</a>
07518-62	PPS/SS	<a href="#">HL-07518-69</a>

### L/S EASY-LOAD® II PUMP HEAD PARTS

Replacement rotor assembly for Easy-Load® II pump heads

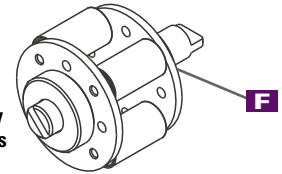

**F Rotor Assemblies**

For pump head	Body/rotor material <sup>†</sup>	Catalog number
77200-50	PPS/CRS	<a href="#">HL-77200-58</a>
77200-52		<a href="#">HL-77200-59</a>
77200-60, 77201-60	PPS/SS	<a href="#">HL-77200-68</a>
77200-62, 77201-62		<a href="#">HL-77200-69</a>

<sup>†</sup>PPS—Polyphenylene sulfide PSF—Polysulfone PC—Polycarbonate  
CRS—Cold-rolled steel SS—Stainless steel

**Tubing Retainer Kits** (not shown)

For pump head	Catalog number
77200-50, 77200-60, 77201-60	<a href="#">HL-77200-90</a>
77200-52, 77200-62, 77201-62	<a href="#">HL-77200-92</a>
77202-50, 77202-60	<a href="#">HL-77200-94</a>

### L/S HIGH-PERFORMANCE 77250-62 PUMP HEAD PARTS

- G** [HL-77250-69](#) Rotor assembly with clip
- H** [HL-77250-66](#) Tubing retainer kit
- I** [HL-77250-67](#) Occlusion bed assembly with clip
- [HL-77250-01](#) Mounting screws (not shown)

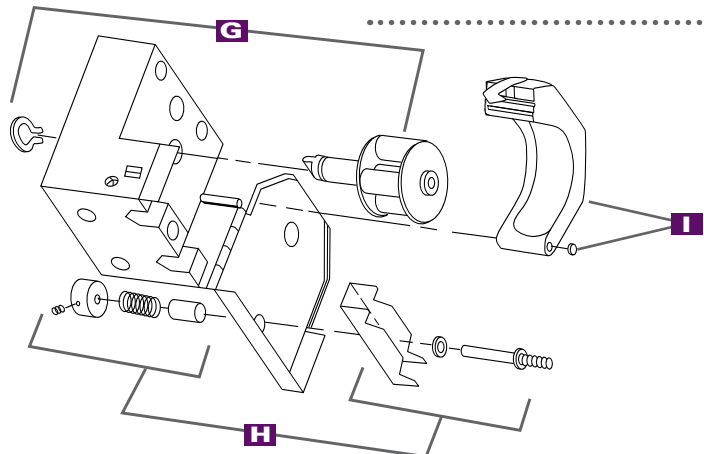

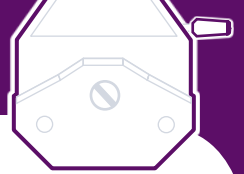

## I/P STANDARD 07019-SERIES PUMP HEAD PARTS

**J End Bell Assemblies.** Two required for a complete head assembly.

For pump heads	Housing material†	Catalog number
07019-00, -20	PC/CRS	<a href="#">HL-07019-78</a>
07019-01, -21	PC/SS	<a href="#">HL-07019-79</a>
07019-40, -41, -42, -43	PPS/SS	<a href="#">HL-07019-73</a>
07019-25, -32	PC/CRS	<a href="#">HL-07019-74</a>
07019-26, -31	PC/SS	<a href="#">HL-07019-75</a>
07019-35, -36, -51, -53	PPS/SS	<a href="#">HL-07019-77</a>

**K Rotor Assemblies**

For pump heads	Housing material†	Catalog number
07019-20, -32, -36, -40	CRS	<a href="#">HL-07019-82</a>
07019-21, -31, -43, -53	SS	<a href="#">HL-07019-85</a>

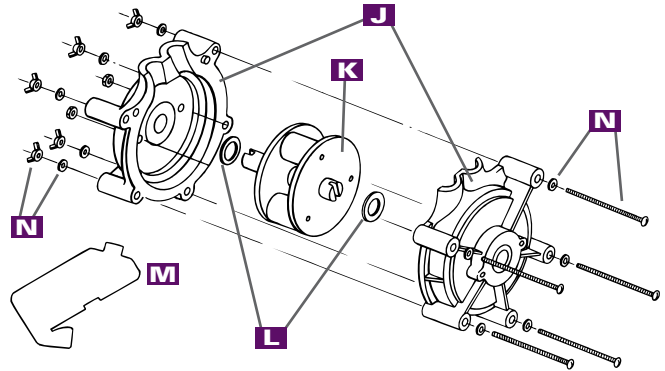

**L HL-07019-92 Thrust washers.** Pack of 10

**M HL-07019-90 Tubing loading key.** Use to properly install tubing in pump head.

**N Mounting hardware** (Stainless steel) for all I/P Standard pump heads. Includes five #10-24 mounting screws with #10 washers and wing nuts

[HL-07019-95](#) For mounting one head

[HL-07019-96](#) For mounting two heads

[HL-77600-03](#) Replacement tang boots (not shown). Pack of 10

## I/P EASY-LOAD® 77601-SERIES PUMP HEAD PARTS

**O Main Body/Occlusion Bed Assemblies** with rear bearing

For pump heads	Housing material†	Catalog number
77601-00, -02	PSF/CRS	<a href="#">HL-77601-07</a>
77601-10, -12	PSF/SS	<a href="#">HL-77601-17</a>
77601-60, -62	PPS/SS	<a href="#">HL-77601-67</a>

**P Rotor/Bearing Support Assemblies** for short shaft pump heads

For pump head	Housing material†	Catalog number
77601-00	PSF/CRS	<a href="#">HL-77601-08</a>
77601-10, -12	PSF/SS	<a href="#">HL-77601-18</a>
77601-60	PPS/SS	<a href="#">HL-77601-68</a>

**Q Tubing Retainer Kit.** Includes two retainer assemblies, PSF and PPS back plates and screws.

Pump head material	Catalog number
Polysulfone (PSF) and Polyphenylene sulfide (PPS)	<a href="#">HL-77601-06</a>

**R Mounting hardware (Stainless steel)** for I/P Easy-Load 77601-series pump heads. Includes five #10-24 mounting screws.

Number of heads to be mounted	Catalog number
One	<a href="#">HL-77601-95</a>
Two	<a href="#">HL-77601-96</a>

†PPS—Polyphenylene sulfide PSF—Polysulfone PC—Polycarbonate  
CRS—Cold-rolled steel SS—Stainless steel

[HL-77600-03](#) Replacement tang boots (not shown). Pack of 10

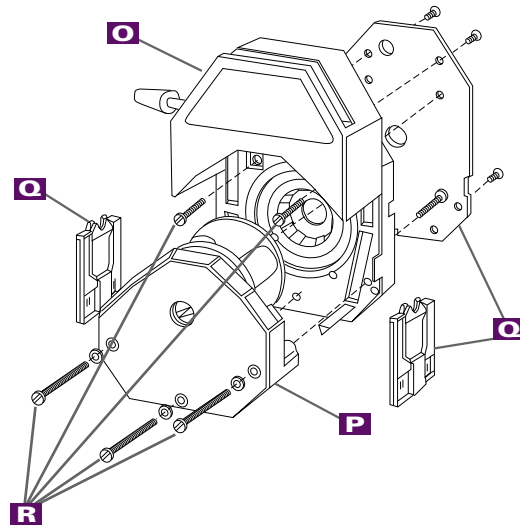

## I/P HIGH-PERFORMANCE 77600-62 PUMP HEAD PARTS

**S HL-77600-69 Rotor/Body kit** (includes rotor/body assembly with tang boot)

**T HL-77600-66 Tubing retainer kit** (includes retainer, adjusting screw, spacer, spring, washers, and knob)

**U HL-77600-67 Occlusion bed assembly kit** (includes occlusion bed assembly, washers, and retaining clip)

**V HL-77600-03 Replacement tang boot.** Pack of 10.

[HL-77600-01](#) Mounting screws (not shown). Set of four #10-24 screws

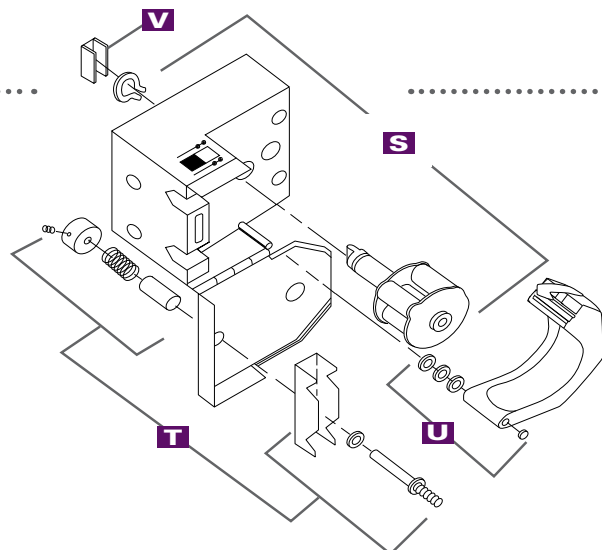

## REPLACEMENT PARTS FOR MASTERFLEX® DRIVES

### L/S® GEAR SERVICE KITS

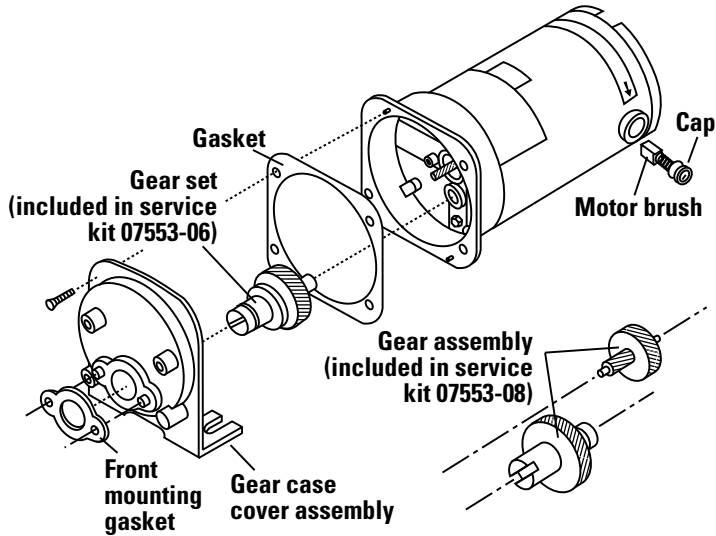

**HL-07553-06 Service kit** for 600 rpm drives listed below. Contains gear assembly (nylon gear/shaft), gear case cover gasket, replacement fuse, and instructions

**HL-07553-09 Gear only** (nylon gear)

Masterflex® L/S® drives, 6 to 600 rpm		
07520-00, -20, -25, -40, -45	07524-40, -45	07554-00, -02, -20, -90, -95
07520-47, -60, -65, -67	07525-34, -36	07557-00, -60
07521-00, -25, -40, -45, -47	07526-00, -05	07558-15, -25, -35, -40, -45, -50
07522-10, -15, -20	07527-00, -20, -30, -32, -34, -36	07558-55, -70, -75
07523-00, -02, -20, -25, -27	07528-00, -05, -10	07562-00
07562-00	07531-00	07569-00
07523-40, -47, -60, -80	07532-00, -02	77301-40, -50
	07533-30, -40, -60, -80	77521-40, -47
	07550-10, -17, -30	
	07551-00	
	07552-02, -04, -70, -75	
	07553-00, -02, -04, -20, -70, -75, -77	

**HL-07553-08 Service kit** for 100 rpm drives listed below. Contains two gear assemblies (large and small), two gear case cover gaskets, one vial of high-temperature silicone grease, and instructions

Masterflex® L/S® drives, 1 to 100 rpm		
07520-10, -30, -35, -50, -55, -57	07525-30, -32	07553-87, -89
07521-10, -30, -35, -50, -55, -57	07528-30	07554-12, -30
07522-00, -05, -30	07531-10	07557-10, -70
07523-10, -12, -30, -35, -70	07532-10, -12	07558-80, -85
07523-37, -50, -57, -70, -90	07533-10, -20, -50, -70	07562-10
07524-50, -55	07550-20, -22, -50	07567-70, -80,
	07551-10	07567-90, -95
	07553-12, -14, -30, -80, -85	77521-50, -57

**HL-77300-01 Service kit** for 10 to 600 rpm digital modular drives 77301-20 and 77301-30. Contains gear assembly (nylon gear/shaft), gear case cover gasket, and instructions

## INNOCAL®

### Preventive Maintenance Package for Masterflex® L/S® Pumps

Experienced, factory-trained technicians perform preventive maintenance activities including safety inspection, replacement or service of wearable parts, asset tagging, and a detailed Service Inspection Report. See page 109 for more information.

**HL-17110-00 Pump preventive maintenance package**

### L/S® AND I/P® MODULAR DRIVE REPLACEMENT MOTORS



For modular drive	Motor speed (rpm)	Motor Cat. no.
<b>L/S modular drives</b>		
07552-70	600	<a href="#">HL-07552-02</a>
07552-75	600	<a href="#">HL-07552-04</a>
07553-20, -70	600	<a href="#">HL-07553-02</a>
07558-15, -30, -35, -50, -70	600	
07553-10, -30, -80	100	<a href="#">HL-07553-12</a>
07558-80	100	
07567-50, -70, -90	100	
07553-75	600	<a href="#">HL-07553-04</a>
07558-25, -45, -55, -75	600	
07553-85; 07567-95; 07558-85	100	<a href="#">HL-07553-14</a>
07553-77	600	<a href="#">HL-07553-79</a>
07553-87	100	<a href="#">HL-07553-89</a>

<b>L/S digital modular drives</b>		
77301-20, -30	600	<a href="#">HL-77301-21</a>
<b>I/P modular drives</b>		
07591-00, -10	650	<a href="#">HL-07591-50</a>
07591-07, -15	650	<a href="#">HL-07591-55</a>
<b>I/P digital modular drives</b>		
07592-20, -30	650	<a href="#">HL-07592-40</a>
07592-27, -35	650	<a href="#">HL-07592-45</a>

### L/S® AND I/P® MODULAR DRIVE REPLACEMENT COMPONENTS

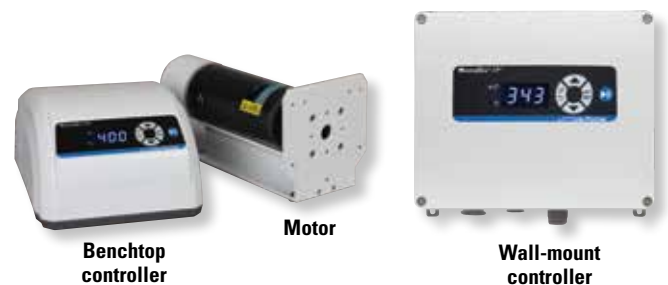

For modular drive	Controller Cat. no.	Motor Cat. no.
<b>L/S precision modular drives</b>		
07557-00	<a href="#">HL-07557-04</a>	<a href="#">HL-07557-02</a>
07557-10	<a href="#">HL-07557-14</a>	<a href="#">HL-07557-12</a>
07557-60	<a href="#">HL-07557-64</a>	<a href="#">HL-07557-62</a>
07557-70	<a href="#">HL-07557-74</a>	<a href="#">HL-07557-72</a>
<b>L/S modular dispensing drives</b>		
77301-40	<a href="#">HL-77301-44</a>	<a href="#">HL-77301-42</a>
77301-50	<a href="#">HL-77301-54</a>	<a href="#">HL-77301-52</a>
<b>I/P precision modular drives</b>		
07591-20	<a href="#">HL-07591-24</a>	<a href="#">HL-07591-22</a>
07591-30	<a href="#">HL-07591-34</a>	<a href="#">HL-07591-32</a>
<b>I/P modular dispensing drives</b>		
07594-00	<a href="#">HL-07594-04</a>	<a href="#">HL-07594-02</a>
07594-10	<a href="#">HL-07594-14</a>	<a href="#">HL-07594-12</a>

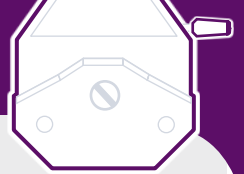

## FUSES



For Masterflex® drive(s)	Fuse Cat. no. (Pack of 2)	Fuse rating	Size	Type
07520-40, -50, -60	<a href="#">HL-77500-25</a>	3.15 A/250 V	5 x 20 mm	Slo-Blo
07520-47, -57, -67	<a href="#">HL-77500-11</a>	1.6 A/250 V	5 x 20 mm	Slo-Blo
07523-40, -50, -60, -70, -80, -90	<a href="#">HL-77500-25</a>	3.15 A/250 V	5 x 20 mm	Slo-Blo
07523-47, -57	<a href="#">HL-77500-11</a>	1.6 A/250 V	5 x 20 mm	Slo-Blo
07524-40, -50	<a href="#">HL-77500-25</a>	3.15 A/250 V	5 x 20 mm	Slo-Blo
07524-45, -55	<a href="#">HL-77500-11</a>	1.6 A/250 V	5 x 20 mm	Slo-Blo
07528-10, -20, -30	<a href="#">HL-77500-25</a>	3.15 A/250 V	5 x 20 mm	Slo-Blo
07549-44, -64	<a href="#">HL-77500-06</a>	3 A/250 V	3 AG	Standard
07550-30, -50	<a href="#">HL-77500-25</a>	3.15 A/250 V	5 x 20 mm	Slo-Blo
07551-00, -10	<a href="#">HL-77500-25</a>	3.15 A/250 V	5 x 20 mm	Slo-Blo
07552-70, -71	<a href="#">HL-77500-06</a>	3 A/250 V	3 AG	Standard
07552-75, -76	<a href="#">HL-77500-12</a>	1.5 A/250 V	3 AG	Standard
07553-75, -76, -77, -85, -87	<a href="#">HL-77500-11</a>	1.6 A/250 V	5 x 20 mm	Slo-Blo
07554-80, -90	<a href="#">HL-77500-10</a>	2.0 A/125 V	3 AG	Slo-Blo
07554-85, -95	<a href="#">HL-77500-58</a>	1 A/250 V	5 x 20 mm	Slo-Blo
07575-00, -10	<a href="#">HL-77500-25</a>	3.15 A/250 V	5 x 20 mm	Slo-Blo
07591-00, -10, -60, -70	<a href="#">HL-77500-02</a>	5 A/250 V	3 AG	Slo-Blo
07591-05, -07, -15, -65, -67, -75	<a href="#">HL-77500-08</a>	2.5 A/250 V	5 x 20 mm	Slo-Blo
07592-20, -30, -82, -90	<a href="#">HL-77500-24</a>	6.3 A/250 V	5 x 20 mm	Slo-Blo
07592-27, -35, -85, -95	<a href="#">HL-77500-25</a>	3.15 A/250 V	5 x 20 mm	Slo-Blo
77111-10, -37, -40	<a href="#">HL-77500-27</a>	8 A/250 V	5 x 20 mm	Slo-Blo
77111-30	<a href="#">HL-77500-30</a>	15 A/250 V	5 x 20 mm	Slo-Blo
77111-47, -67	<a href="#">HL-77500-26</a>	4 A/250 V	5 x 20 mm	Slo-Blo
77111-60	<a href="#">HL-77500-28</a>	8 A/250 V	3 AG	Slo-Blo
77300-20, -30	<a href="#">HL-77500-25</a>	3.15 A/250 V	5 x 20 mm	Slo-Blo
77300-25, -35	<a href="#">HL-77500-11</a>	1.6 A/250 V	5 x 20 mm	Slo-Blo
77301-20, -22, -23, -30	<a href="#">HL-77500-25</a>	3.15 A/250 V	5 x 20 mm	Slo-Blo
77310-00, -01	<a href="#">HL-77500-08</a>	2.5 A/250 V	5 x 20 mm	Slo-Blo
77340-00	<a href="#">HL-77500-08</a>	2.5 A/250 V	5 x 20 mm	Slo-Blo
77410-00, -10	<a href="#">HL-77500-24</a>	6.3 A/250 V	5 x 20 mm	Slo-Blo
77410-05	<a href="#">HL-77500-25</a>	3.15 A/250 V	5 x 20 mm	Slo-Blo
77411-00	<a href="#">HL-77500-24</a>	6.3 A/250 V	5 x 20 mm	Slo-Blo
77420-00	<a href="#">HL-77500-24</a>	6.3 A/250 V	5 x 20 mm	Slo-Blo
77521-40, -50	<a href="#">HL-77500-25</a>	3.15 A/250 V	5 x 20 mm	Slo-Blo
77521-47, -57	<a href="#">HL-77500-11</a>	1.6 A/250 V	5 x 20 mm	Slo-Blo

## TANG ADAPTERS



**Tang adapter kit** provides a tight tang shaft connection and reduces noise. Includes two large and two small adapters. Use large adapter for 75 W systems; small adapter for 37 W systems.

Cat. no.	Fit pump head series/model
<a href="#">HL-07519-01</a>	07090-42, -62 07519-05, -06, -10, -15, -20, -25

## BRUSH CAPS AND BRUSHES

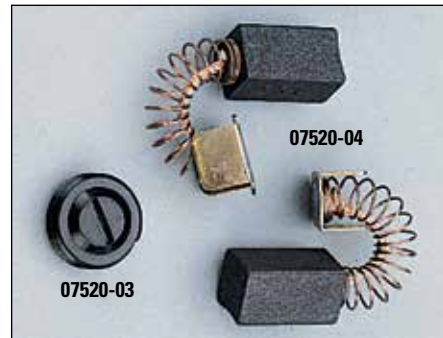

**Brush Caps** work with all 1/20 hp (37 W), 1/10 hp (75 W), and 1/5 hp (150 W) drive series listed below. Pack of 2.

Cat. no.	Fit drive series/model			
<a href="#">HL-07520-03</a>	07520	07526	07554 <sup>†</sup>	75210
	07521	07550 <sup>†</sup>	07591	75211
	07523	07552	07592	77300
	07524 <sup>††</sup>	07553 <sup>††</sup>	07593	77521

**Brushes** work with all 1/20 hp (37 W), 1/10 hp (75 W), and 1/5 hp (150 W) drive series listed below. Pack of 2.

Cat. no.	Fit drive series/model			
<a href="#">HL-07520-04</a>	07520	07526	07554 <sup>†</sup>	75210
	07521	07550 <sup>†</sup>	07591	75211
	07523	07552	07592	77300
	07524 <sup>††</sup>	07553 <sup>††</sup>	07593	77521
<a href="#">HL-07520-06</a>	07554-80, -85, -90, -95			

<sup>†</sup>Except 07554-52, -60, -80, -85, -90, -95

<sup>‡</sup>Except 07550-60, -62, -67, -90, -92

<sup>††</sup>Except 07524-00, -05, -10, -15

<sup>†††</sup>Except 07553-50, -60

## POWER CORD/PLUG SETS

A detachable cord/plug set will automatically be included with most 230 VAC drives and will be selected based on the country of destination. Below is a reference table of the available cord/plug sets. Cord/plug sets feature a country-specific male plug on one end and an IEC 320 female plug on the other end. Order a cord/plug set to replace a lost or damaged set or to use your 230 VAC drive in another country. Most 230 VAC drives use the country-specific cord/plug sets; see the specific Masterflex drive page in this catalog to determine if your drive uses these cord/plug sets.

### REFERENCE GUIDE

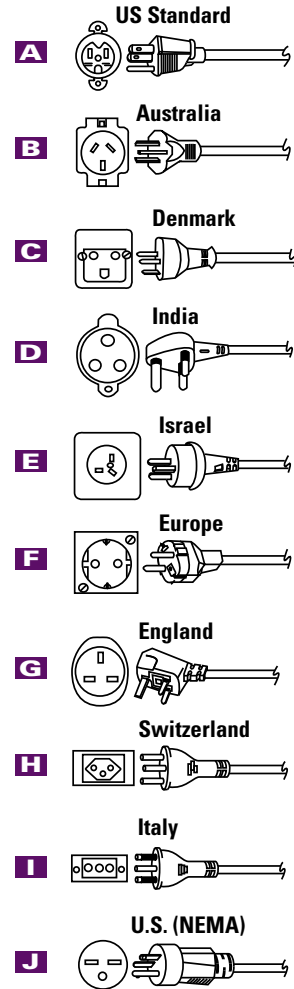

**IEC 320 socket is featured on most Masterflex drives and on the Liqui-Sense® monitor.**

Key	Catalog number	Description
<b>A</b>	<a href="#">HL-50001-68</a>	US Standard (115 VAC)
<b>B</b>	<a href="#">HL-50001-60</a>	Australia
<b>C</b>	<a href="#">HL-50001-62</a>	Denmark
<b>D</b>	<a href="#">HL-50001-64</a>	India
<b>E</b>	<a href="#">HL-50001-69</a>	Israel
<b>F</b>	<a href="#">HL-50001-70</a>	Europe
<b>G</b>	<a href="#">HL-50001-72</a>	England
<b>H</b>	<a href="#">HL-50001-74</a>	Switzerland
<b>I</b>	<a href="#">HL-50001-76</a>	Italy
<b>J</b>	<a href="#">HL-50001-78</a>	US NEMA (230 VAC)

## MASTERFLEX® TUBING AND GENERAL TECHNICAL DATA

### TABLE OF CONTENTS

#### Masterflex® Performance Data

C/L® tubing life data.....	172
L/S® tubing life data.....	173–175
I/P® tubing life data.....	176–178
B/T® tubing life data.....	179–180
Flow rates for Masterflex® pump heads.....	181–183
Pressure and suction lift data for Masterflex® pump heads.....	184–185
Pump head torque requirements.....	186–187
Application tips	
Dispensing applications.....	188–189
Pumping abrasive fluids.....	190
Pumping viscous fluids.....	190–191
Tubing selection guide for viscous fluids.....	191
Vacuum/suction lift data.....	192

#### General Technical Data

Agency approvals and cord/plug guide.....	193
IP ratings, NEMA ratings, pipe thread sizes.....	194
ATEX and NEC classifications.....	195
Glossary of terms.....	196
Conversion factors.....	197
Chemical resistance charts.....	198–206

### TUBING SELECTION GUIDELINES

Tubing life performance is just one of many factors present in your pumping applications. The charts in this section and the information on pages 19–31 will assist you in selecting tubing for your pumping application.

Tubing life is shown in hours at various motor speeds while continuously pumping water at 21°C (70°F) and 0 psig (0 bar). Masterflex® tubing life data is calculated from time to failure or reduction to 50% flow rate, whichever comes first.

#### In general:

- ▶ The Norprene®, PharMed® BPT, and PharmaPure® tubing formulations offer the best tubing life in all applications where the fluid being pumped is chemically compatible
- ▶ High-performance precision tubing has a 20 to 30% increased tubing life over Precision tubing
- ▶ High-pressure Norprene and PharMed BPT have the best life in pressure applications
- ▶ Peroxide-cured silicone tubing offers up to 40% more tubing life. Platinum-cured silicone tubing offers better biocompatibility and fewer extractables. BioPharm Plus platinum-cured silicone tubing lasts up to five times longer than other platinum-cured silicone tubings and is the recommended formulation for high-accuracy dispensing applications (see pages 188–189).

#### Other factors to consider when determining the best tubing for your application:

- ▶ Fluid compatibility
- ▶ Fluid temperature
- ▶ System pressure
- ▶ Motor rpm
- ▶ Clarity of tubing
- ▶ Duty cycle
- ▶ Maintenance periods
- ▶ Tubing purity
- ▶ Viscosity

#### Once tubing has been selected:

1. Test it in your application.
2. Monitor tubing life in duty cycle, look for signs of tubing fatigue (e.g. small pinhole leaks, abrasion, etc.).
3. Set up maintenance schedule to anticipate tubing failure.

Monitor the time tubing is in the pump. Advance it 8 to 12 inches on a daily, weekly, monthly, or quarterly basis, depending on your experience with your maintenance schedule.

### TESTING PARAMETERS

The charts found on pages 172–180 indicate the average life of Masterflex® tubing used in our Standard-style pump heads unless otherwise noted. The tubing life is shown in hours at various motor speeds while continuously pumping water at 21°C (70°F) and 0 psig (0 bar). This data has been collected from years of testing Masterflex® peristaltic pumps. Masterflex® tubing life data is calculated from time to failure or reduction to 50% flow rate, whichever comes first.

These charts are best used as a general comparison only. It is not guaranteed that you will achieve the results shown. Generally, the life of all types of tubing is adversely affected by temperature, pump motor rpm, chemical compatibility, and pressure.



Tubing performance data presented in this catalog is the result of years of rigorous testing under actual application conditions.

### C/L® MICROBORE TUBING LIFE DATA

This graph shows average tubing life, by tubing size, of C/L® silicone and C/L® Tygon® while pumping water through a C/L® variable-speed pump 77120-series at 21°C (70°F) with 0 psig at 300 rpm.

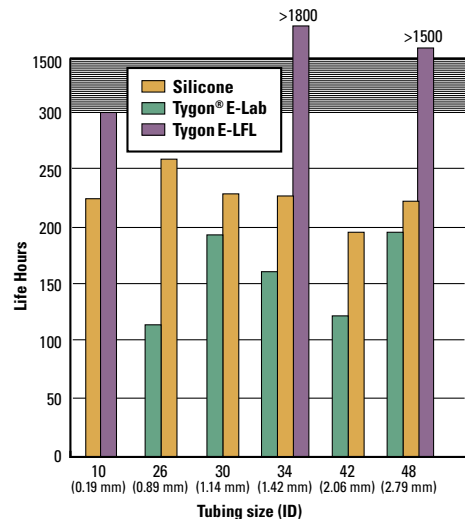

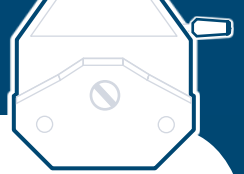

## L/S® PRECISION AND HIGH-PERFORMANCE PRECISION TUBING

- ▶ Tubing Life
- ▶ Pressure Guidelines
- ▶ Vacuum/Suction Lift
- ▶ Gas Permeability

Ensure top performance with your Masterflex® pump head by using precision-extruded Masterflex® tubing to deliver accurate flow rates. Twenty-two different material formulations are available.

To order the correct tubing:

1. Consider all the aspects of your application: flow rate, pressure, etc.
2. Review the chemical compatibility data on pages 30-31, as well as specific information about individual tubing materials on pages 22-29.
3. Use the "Tubing Material Life Comparison" graph and table at right to select the tubing with the longest life.

If your application requires the generation of high pressure or a strong vacuum/suction lift, refer to the "Pressure Guidelines" and "Vacuum/Suction Lift" graphs at right. These graphs can assist you in determining which tubing will pressurize most rapidly or develop the strongest vacuum/suction lift in your application.

If your application requires pumping air-sensitive gases or liquids, refer to the "Gas Permeability" graph below right to choose the tubing with the lowest permeability.

If you are pumping a viscous fluid, refer to the "Tubing Selection Guide for Pumping Viscous Fluids" graph on page 191 to select the best tubing size.

### FREE TUBING TEST KIT!

Our FREE Tubing Test Kit is a simple way to test your chemicals against different tubing formulations. Kit contains samples of different pump tubing formulations, formulation descriptions, a selection guide, instructions on how to test your tubing, and complete ordering information. Call today! Request item HL-00101-10.

**Call or go online to request your FREE test kit today!**



SEE PAGES 68-73

for L/S® pump tubing ordering information.

### TUBING MATERIAL LIFE COMPARISON

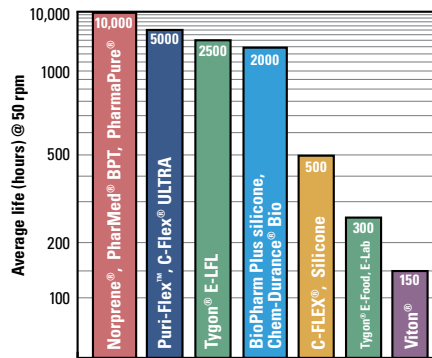

The graph above displays the average tubing life in hours of Masterflex® L/S® 16 tubing. This tubing was tested in a Masterflex® Standard pump head continuously pumping water at 21°C (70°F) and 0 psig (0 bar). Tubing life is calculated to time of failure or of 50% reduction in flow rate, whichever comes first. Reduce drive speeds to extend tubing life. Average tubing life for L/S® 16, I/P® 73, and B/T® 91 tubing at various speeds are listed in the table below.

Tubing class	L/S® 16		I/P® 73		B/T® 91	
	Drive rpm 50	600	50	600	50	321
Norprene®, PharMed® BPT, PharmaPure®	10,000	1000	4000	800	3000	600
Puri-Flex™, C-Flex® ULTRA	5000	1000	3000	500	500	100
Tygon® E-LFL	2500	600	800	400	600	200
C-FLEX®, Silicone	500	100	400	80	250	100
Tygon® E-Food	320	80	—	125	—	—
Tygon® E-Lab	320	80	180	380	100	30
Viton®	150	30	120	25	—	—

### L/S® PRECISION TUBING LIFE CHARACTERISTICS

The graph below shows average tubing life vs motor rpm for selected L/S® tubing formulations.

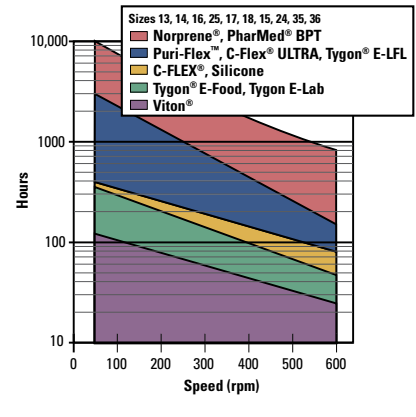

### PRESSURE GUIDELINES

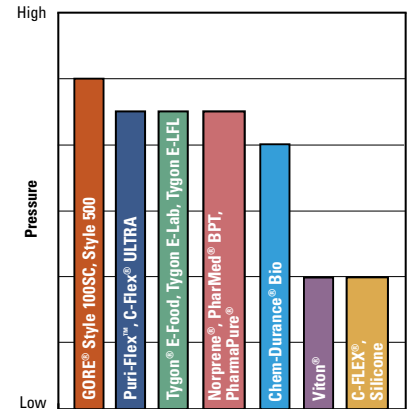

All tubing types accept pressure, but the firmer formulations accept more pressure than the softer types of tubing.

### VACUUM/SUCTION LIFT

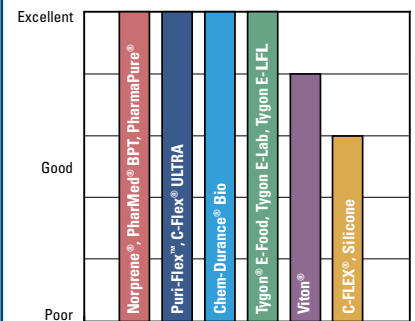

Vacuum/suction lift capability depends greatly on the tubing's ability to maintain its shape. Thus, a firmer tubing type in the smallest possible bore size will generate a stronger vacuum for your application. Higher drive speeds are required to generate the strongest possible vacuum with some tubing sizes.

### GAS PERMEABILITY

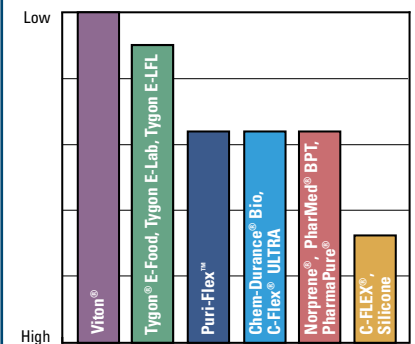

To minimize permeation of gases through the tubing wall, use firm tubing. Masterflex® L/S® High-Performance precision tubing (L/S® 15, L/S® 24, L/S® 35, and L/S® 36) is less permeable than Precision tubing sizes. See pages 20-23 for tubing permeability to various gases.

## L/S® PRECISION AND HIGH-PERFORMANCE PRECISION PUMP TUBING

PERFORMANCE DATA FOR PHARMAPURE®, NORPRENE®, PHARMED® BPT, BIOPHARM PLUS SILICONE, SILICONE, TYGON®, AND VITON® TUBING FORMULATIONS

SEE PAGES 68-73

for L/S® pump tubing ordering information.

### L/S® PRECISION TUBING

Precision tubing (L/S® 13, L/S® 14, L/S® 16, L/S® 25, L/S® 17, and L/S® 18) is made to tight tolerances that ensure accurate flow rates and long tubing life. The graph below shows average tubing life while pumping water through an Easy-Load® II pump head at 21°C (70°F), 0 psi, 600 rpm.

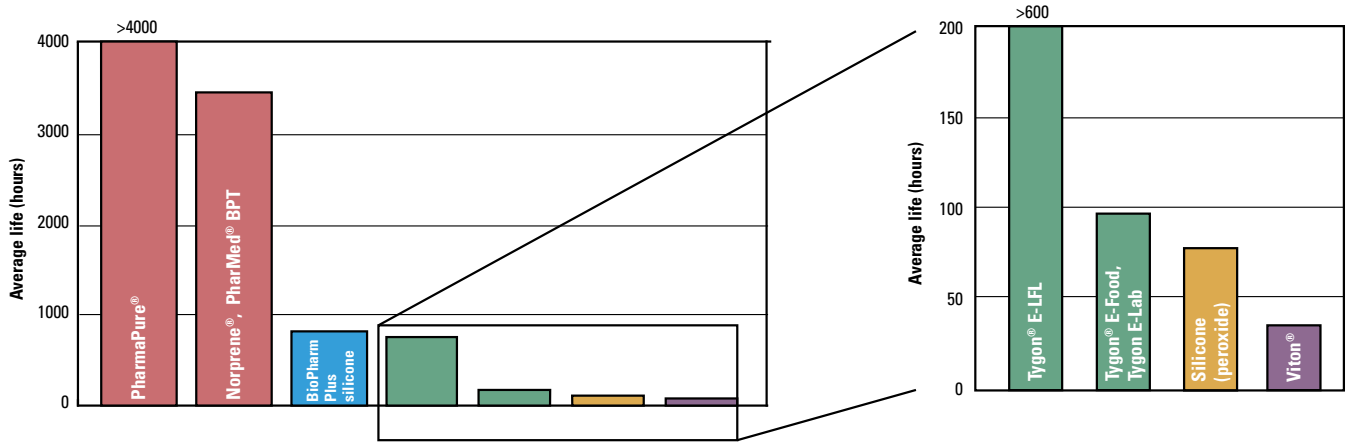

### L/S® HIGH-PERFORMANCE PRECISION TUBING

High-performance precision tubing (L/S® 15, L/S® 24, L/S® 35, and L/S® 36) improves pressure generation, suction lift, tubing life, and the ability to pump viscous fluids. The graph below shows average tubing life while pumping water through an Easy-Load® II pump head at 21°C (70°F), 0 psi, 600 rpm.

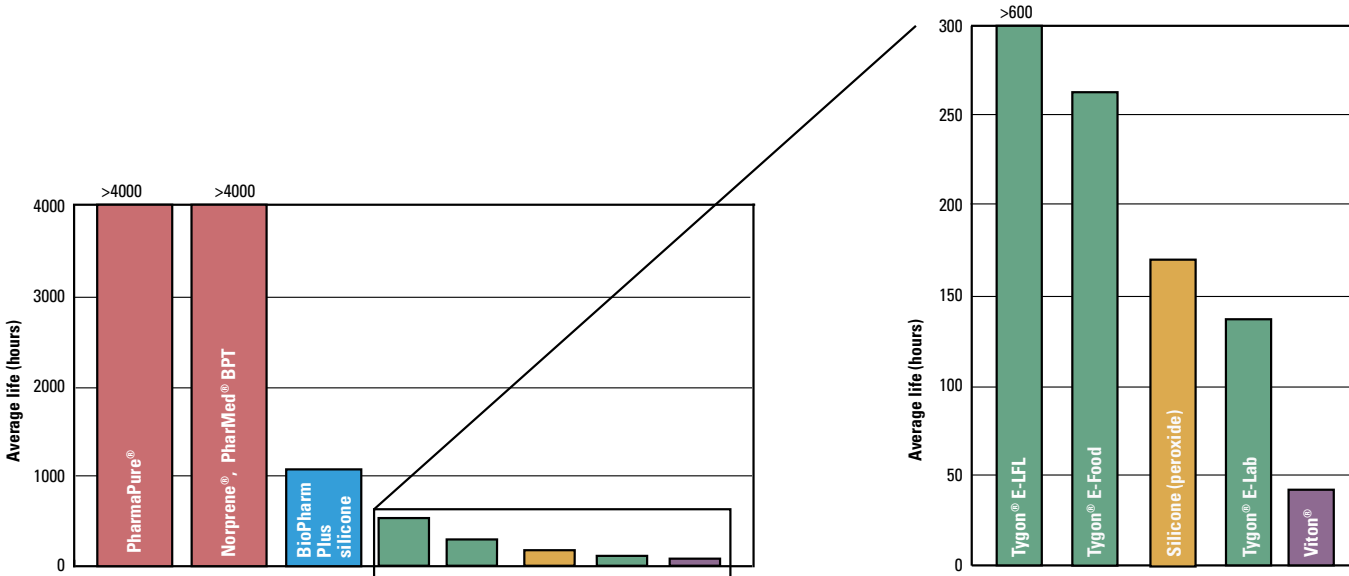



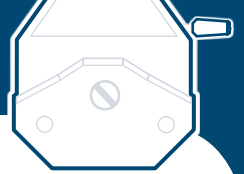

## PERFORMANCE DATA FOR NORPRENE® AND PHARMED® BPT TUBING FORMULATIONS L/S® HIGH-PERFORMANCE PUMP HEAD PUMPING WATER AT 21°C (70°F)

### L/S® HIGH-PERFORMANCE PRECISION TUBING

High-performance precision tubing (L/S® 15, L/S® 24, L/S® 35, and L/S® 36) improves pressure generation, suction lift, tubing life, and the ability to pump viscous fluids. The graph at right shows average tubing life while pumping water through a High-Performance pump head at 21°C (70°F), 600 rpm.

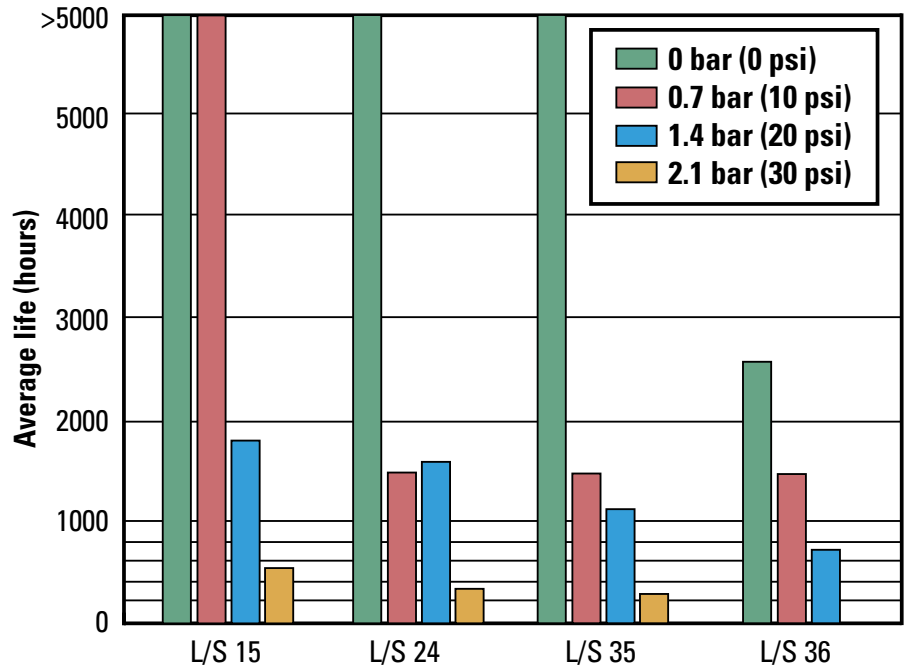

## PERFORMANCE DATA FOR SILICONE (PEROXIDE-CURED) TUBING FORMULATION L/S® HIGH-PERFORMANCE PUMP HEAD PUMPING WATER AT 21°C (70°F)

### L/S® HIGH-PERFORMANCE PRECISION TUBING

High-performance precision tubing (L/S® 15, L/S® 24, L/S® 35, and L/S® 36) improves pressure generation, suction lift, tubing life, and the ability to pump viscous fluids. The graph at right shows average tubing life while pumping water through a High-Performance pump head at 21°C (70°F), 600 rpm.

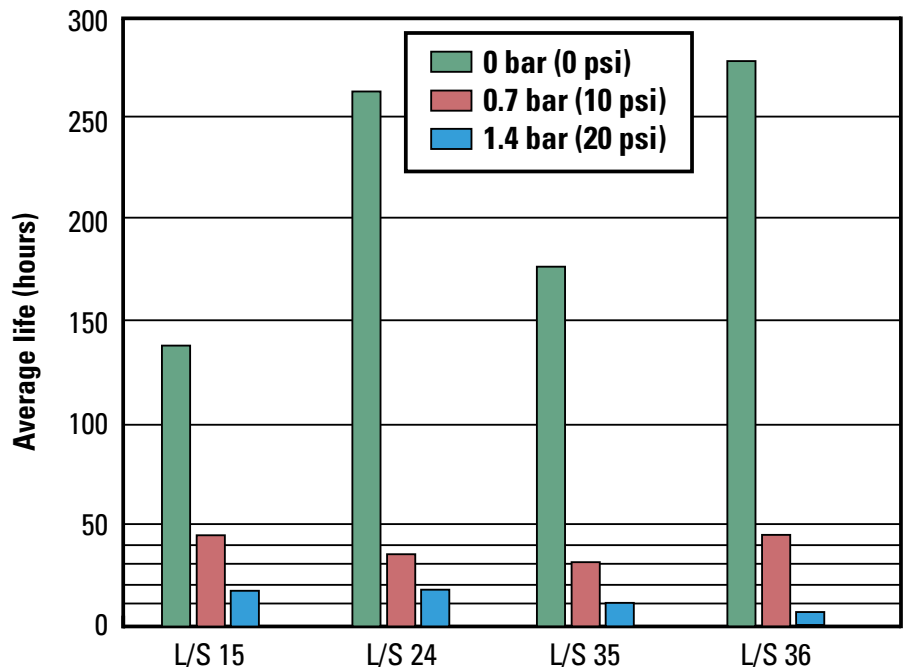

## I/P® PRECISION AND HIGH-PERFORMANCE PRECISION PUMP TUBING

- ▶ Tubing Life
- ▶ Pressure Guidelines
- ▶ Vacuum/Suction Lift
- ▶ Gas Permeability

Ensure top performance with your Masterflex® pump head by using precision-extruded Masterflex® tubing to deliver accurate flow rates. Nineteen different material formulations are available.

To order the correct tubing:

1. Consider all the aspects of your application: flow rate, pressure, etc.
2. Review the chemical compatibility data on pages 30–31, as well as specific information about individual tubing materials on pages 22–29.
3. Use the “Tubing Material Life Comparison” graph and table at right to select the tubing with the longest life.

If your application requires the generation of high pressure or a strong vacuum/ suction lift, refer to the “Pressure Guidelines” and “Vacuum/ Suction Lift” graphs at right. These graphs help you determine which tubing will pressurize the most rapidly or develop the strongest vacuum/suction lift in your application.

If your application requires pumping air-sensitive gases or liquids, refer to the “Gas Permeability” graph below right to choose the tubing with the lowest permeability.

If you are pumping a viscous fluid, refer to the “Tubing Selection Guide for Pumping Viscous Fluids” graph on page 191 to select the best tubing size.

### FREE TUBING TEST KIT!

Our FREE Tubing Test Kit is a simple way to test your chemicals against different tubing formulations. Kit contains samples of different pump tubing formulations, formulation descriptions, a selection guide, instructions on how to test your tubing, and complete ordering information. Call today! Request item HL-00101-10.

**Call or go online to request your FREE test kit today!**



#### WHERE TO ORDER TUBING

C/L® TUBING.....	34, 36
L/S® TUBING.....	68–73
I/P® TUBING.....	126–130
B/T® TUBING.....	153

### TUBING MATERIAL LIFE COMPARISON

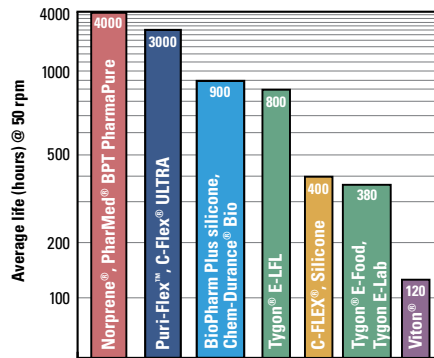

The graph above displays the average tubing life in hours of Masterflex® I/P® 73 tubing. This tubing was tested in a Masterflex® Standard pump head continuously pumping water at 21°C (70°F) and 0 bar (0 psig). Tubing life is calculated to time of failure or of 50% reduction in flow rate, whichever comes first. Reduce drive speeds to extend tubing life. Average tubing life for L/S® 16, I/P® 73, and B/T® 91 tubing at various speeds are listed in the table below.

Tubing class	L/S® 16		I/P® 73		B/T® 91	
	Drive rpm 50	600	50	600	50	321
Norprene®, PharMed® BPT, PharmaPure®	10,000	1000	4000	800	3000	600
Puri-Flex™, C-Flex® ULTRA	5000	1000	3000	500	500	100
Tygon® E-LFL	2500	600	800	400	600	200
C-FLEX®, Silicone	500	100	400	80	250	100
Tygon® E-Food	320	80	—	125	—	—
Tygon® E-Lab	320	80	180	380	100	30
Viton®	150	30	120	25	—	—



### PRESSURE GUIDELINES

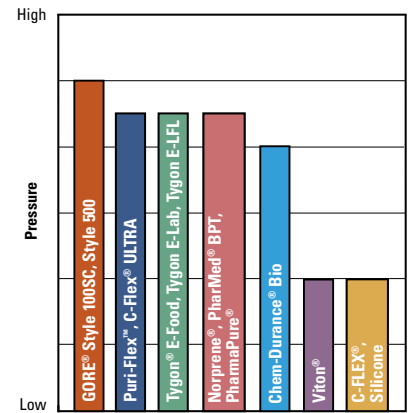

All tubing types accept pressure, but the firmer formulations accept more pressure than the softer types of tubing.

### VACUUM/SUCTION LIFT

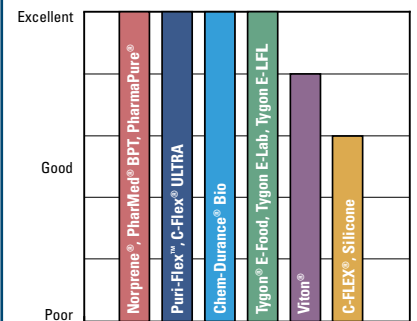

Vacuum/suction lift capability depends greatly on the tubing’s ability to maintain its shape. Thus, a firmer tubing type in the smallest possible bore size will generate a stronger vacuum for your application. Higher drive speeds are required to generate the strongest possible vacuum with some tubing sizes.

### GAS PERMEABILITY

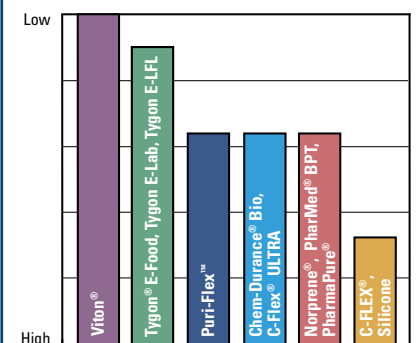

To minimize permeation of gases through the tubing wall, use firm tubing. Masterflex® I/P® High-Performance precision tubing (I/P® 70, I/P® 88, and I/P® 89) is less permeable than Precision tubing sizes. See pages 20–23 for tubing permeability to various gases.

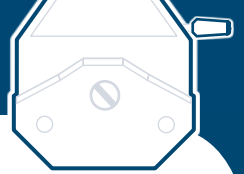

## I/P® PRECISION TUBING LIFE CHARACTERISTICS

Like the I/S® tubing sizes, I/P® sizes I/P® 26, I/P® 73, I/P® 82, I/P® 70, I/P® 88, and I/P® 89 offer excellent pressure generation, suction lift, tubing life, and the ability to pump viscous fluids—all at higher flow rates. This tubing is ideal for industrial applications that require flow rates up to 19 LPM (5.0 GPM).

The graph at right shows average tubing life while pumping water through a Standard pump head at 21°C (70°F).

For example, using this graph it can be determined that the expected average life of Masterflex® I/P® 73 silicone tubing at 300 rpm is about 200 hours.

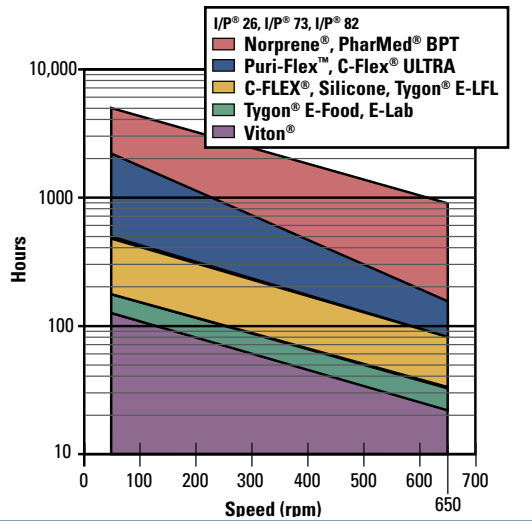

## NOTES

Peroxide-cured silicone tubing offers up to 40% more tubing life. Platinum-cured silicone tubing offers better chemical compatibility. Biopharm Plus silicone tubing lasts up to five times longer than other platinum silicone tubings.

### NORPRENE®, PHARMED® BPT I/P® 73 TUBING IN I/P® STANDARD HEAD (07019-series)

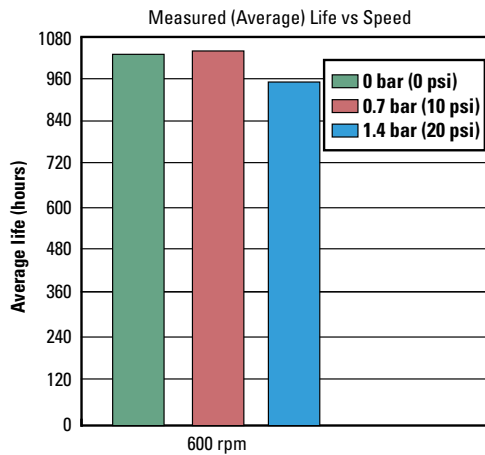

### NORPRENE® IN I/P® EASY-LOAD® PUMP HEAD (77601-series)

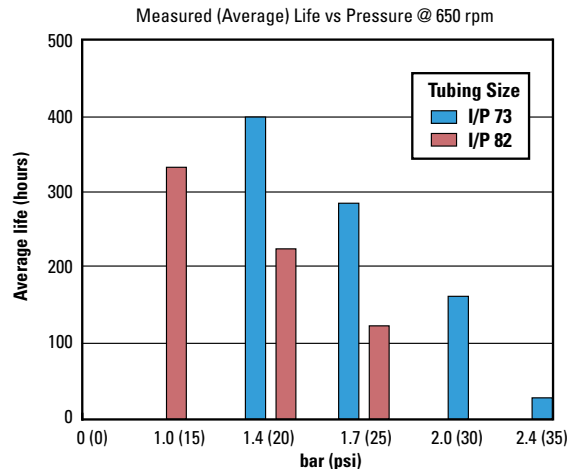

### NORPRENE®, PHARMED® BPT IN I/P® HIGH-PERFORMANCE PUMP HEAD (77600-62)

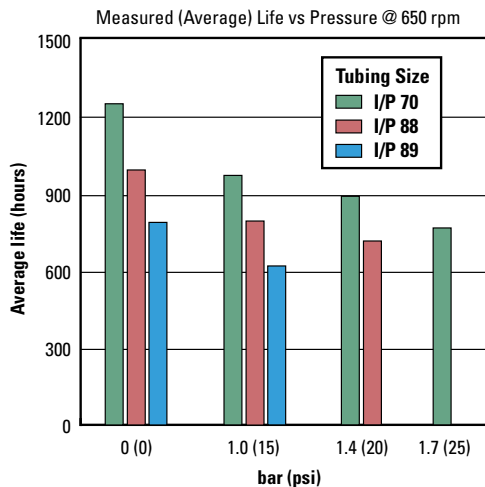

### PEROXIDE-CURED SILICONE IN I/P® HIGH-PERFORMANCE PUMP HEAD (77600-62)

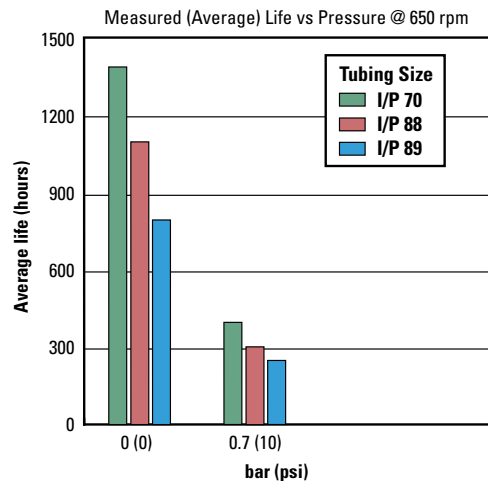

## I/P® PRECISION AND HIGH-PERFORMANCE PRECISION PUMP TUBING

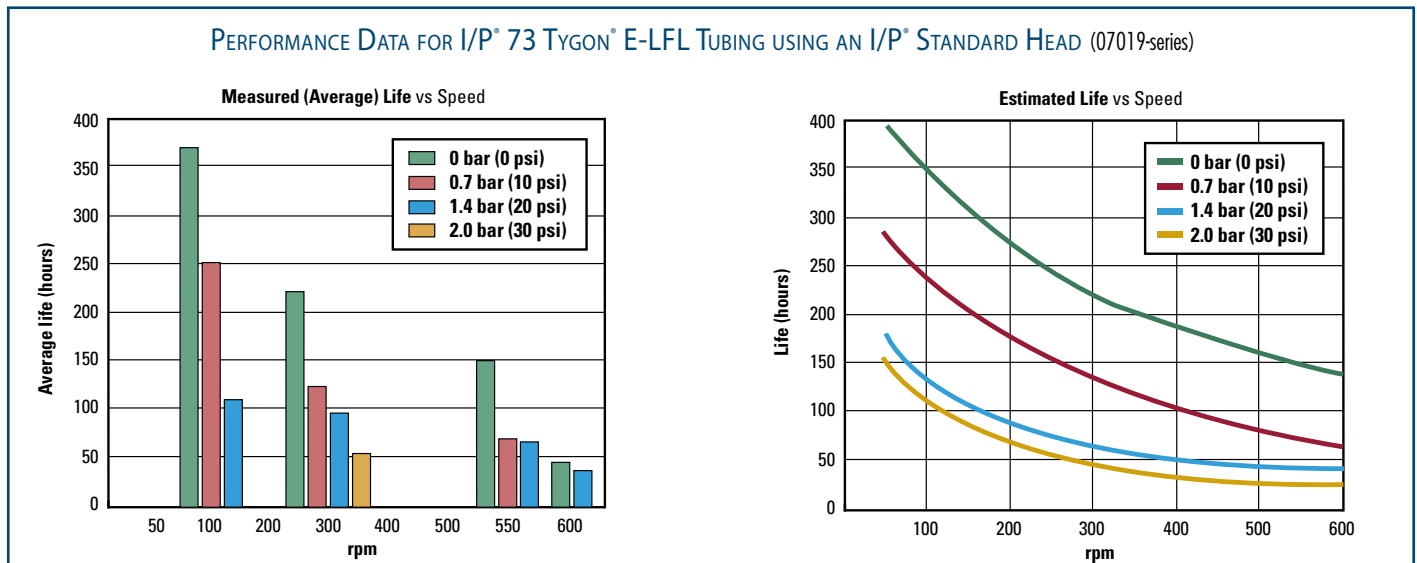
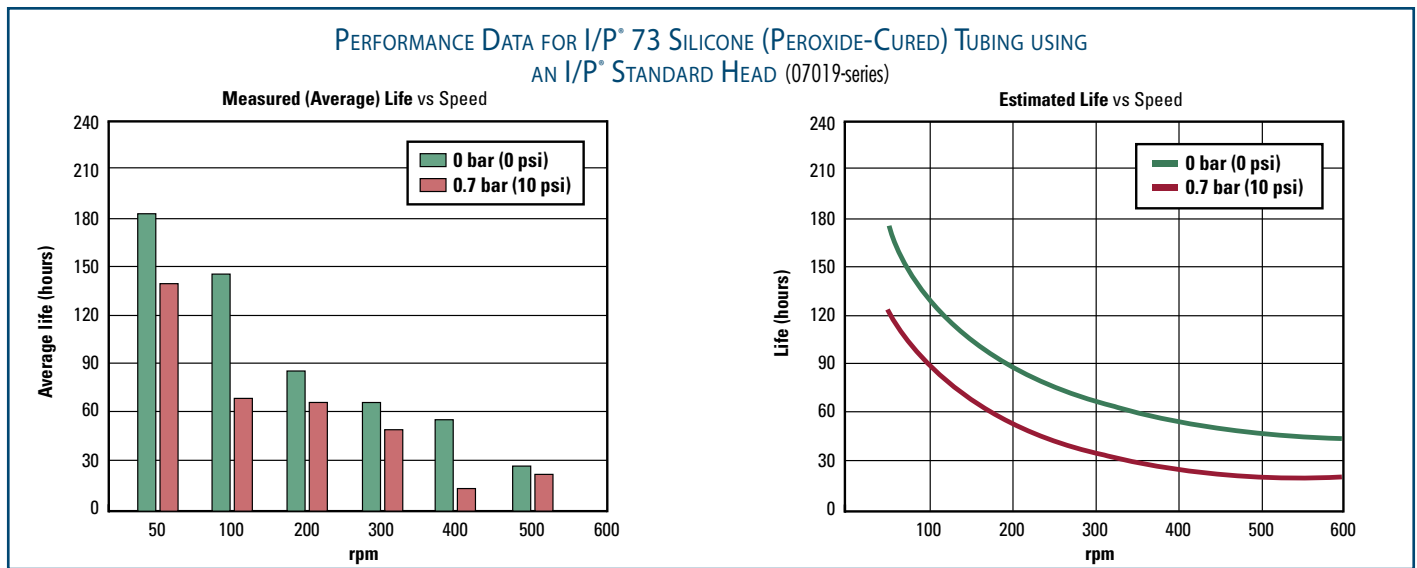
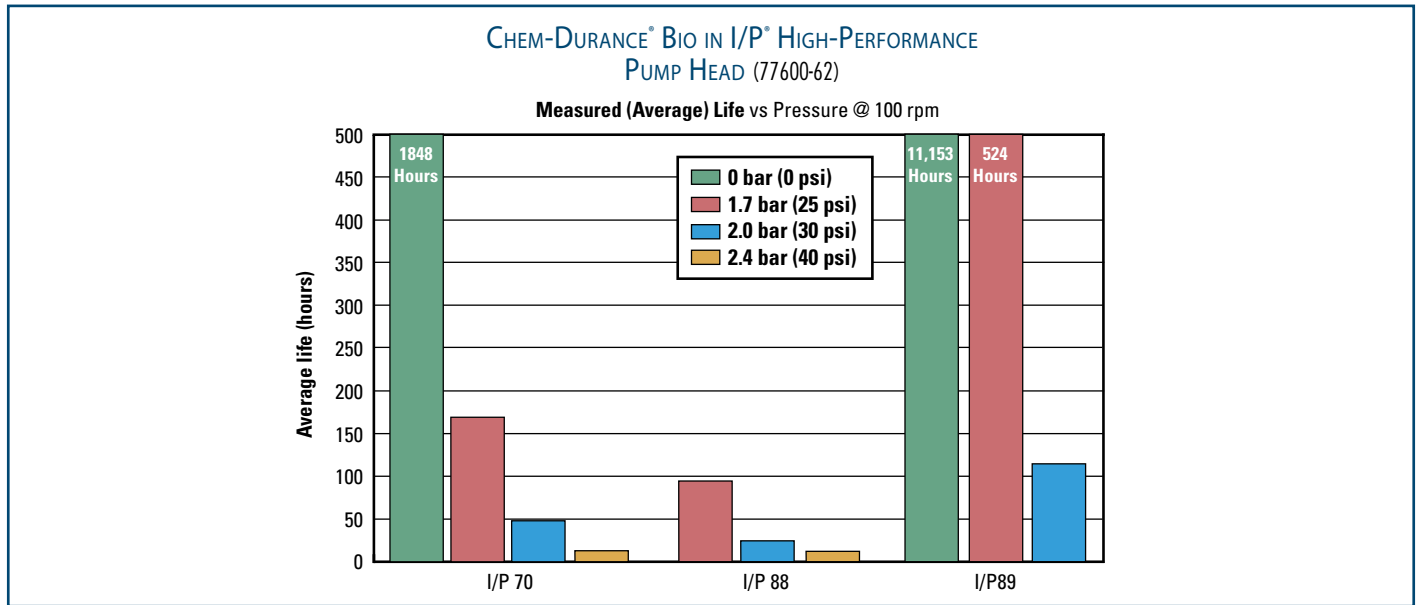

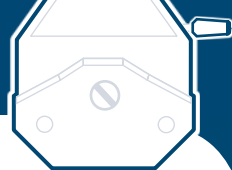

## B/T<sup>®</sup> PERFECTPOSITION<sup>™</sup> PUMP TUBING

- ▶ Tubing Life
- ▶ Pressure Guidelines
- ▶ Vacuum/Suction Lift
- ▶ Gas Permeability

Ensure top performance with your Masterflex<sup>®</sup> pump head by using precision-extruded Masterflex<sup>®</sup> tubing to deliver accurate flow rates. Ten different material formulations are available for B/T<sup>®</sup> pumps.

To order the correct tubing:

1. Consider all the aspects of your application: flow rate, pressure, etc.
2. Review the chemical compatibility data on pages 30–31, as well as specific information about individual tubing materials on pages 22–29.
3. Use the “Tubing Material Life Comparison” graph and table at right to select the tubing with the longest life.

If your application requires the generation of high pressure or a strong vacuum/ suction lift, refer to the “Pressure Guidelines” and “Vacuum/ Suction Lift” graphs at right. These graphs help you determine which tubing will pressurize the most rapidly or develop the strongest vacuum/suction lift in your application.

If your application requires pumping air-sensitive gases or liquids, refer to the “Gas Permeability” graph below right to choose the tubing with the lowest permeability.

If you are pumping a viscous fluid, refer to the “Tubing Selection Guide for Pumping Viscous Fluids” graph on page 191 to select the best tubing size.

### FREE TUBING TEST KIT!

Our FREE Tubing Test Kit is a simple way to test your chemicals against different tubing formulations. Kit contains samples of different pump tubing formulations, formulation descriptions, a selection guide, instructions on how to test your tubing, and complete ordering information. Call today! Request item HL-00101-10.

**Call or go online to request your FREE test kit today!**



### WHERE TO ORDER TUBING

C/L <sup>®</sup> TUBING.....	34, 36
L/S <sup>®</sup> TUBING.....	68–73
I/P <sup>®</sup> TUBING.....	126–130
B/T <sup>®</sup> TUBING.....	153

### TUBING MATERIAL LIFE COMPARISON

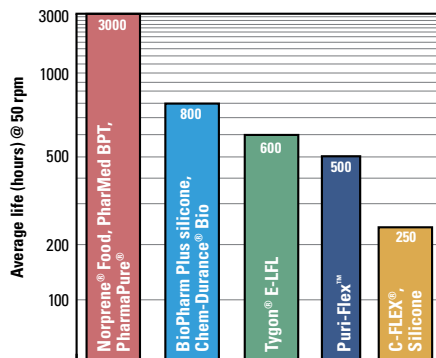

The graph above displays the average tubing life in hours of Masterflex<sup>®</sup> B/T<sup>®</sup> 91 tubing. This tubing was tested in a Masterflex<sup>®</sup> RapidLoad<sup>®</sup> pump head continuously pumping water at 21°C (70°F) and 0 psig (0 bar). Tubing life is calculated to time of failure or of 50% reduction in flow rate, whichever comes first. Reduce drive speeds to extend tubing life. Average tubing life for L/S<sup>®</sup> 16, I/P<sup>®</sup> 73, and B/T<sup>®</sup> 91 tubing at various rpm are listed in the table below.

Tubing class	L/S <sup>®</sup> 16		I/P <sup>®</sup> 73		B/T <sup>®</sup> 91	
	Drive rpm 50	600	50	600	50	321
Norprene <sup>®</sup> , PharMed <sup>®</sup> BPT, PharmaPure <sup>®</sup>	10,000	1000	4000	800	3000	600
Puri-Flex <sup>™</sup> , C-Flex ULTRA	5000	1000	3000	500	500	100
Tygon <sup>®</sup> E-LFL	2500	600	800	400	600	200
C-FLEX <sup>®</sup> , Silicone	500	100	400	80	250	100
Tygon <sup>®</sup> E-Food	320	80	—	125	—	—
Tygon <sup>®</sup> E-Lab	320	80	180	380	—	—
Viton <sup>®</sup>	150	30	120	25	—	—

### NOTES

Use only Masterflex<sup>®</sup> tubing with Masterflex<sup>®</sup> pumps to ensure optimal performance. Use of other tubing may void applicable warranties.



### PRESSURE GUIDELINES

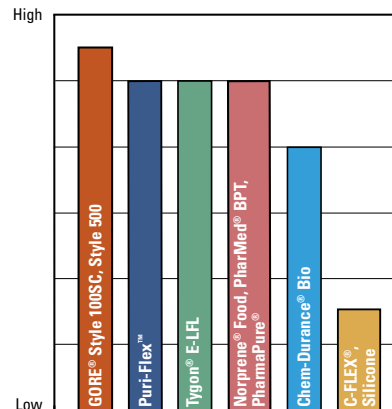

All tubing types accept pressure, but the firmer formulations accept more pressure than the softer types of tubing.

### VACUUM/SUCTION LIFT

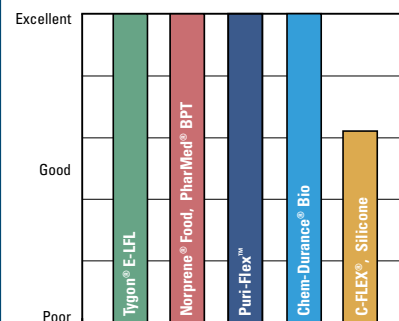

Vacuum/suction lift capability depends greatly on the tubing’s ability to maintain its shape. Thus, a firmer tubing type in the smallest possible bore size will generate a stronger vacuum for your application. Higher drive speeds are required to generate the strongest possible vacuum with some tubing sizes.

### GAS PERMEABILITY

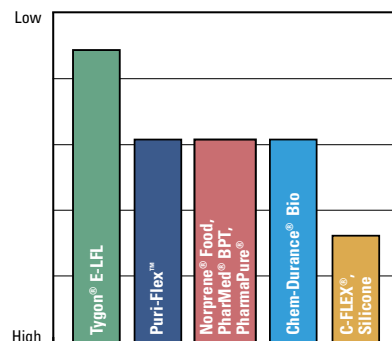

To minimize permeation of gases through the tubing wall, use firm tubing. See pages 20–23 for tubing permeability to various gases.

## B/T® PERFECTPOSITION™ PUMP TUBING

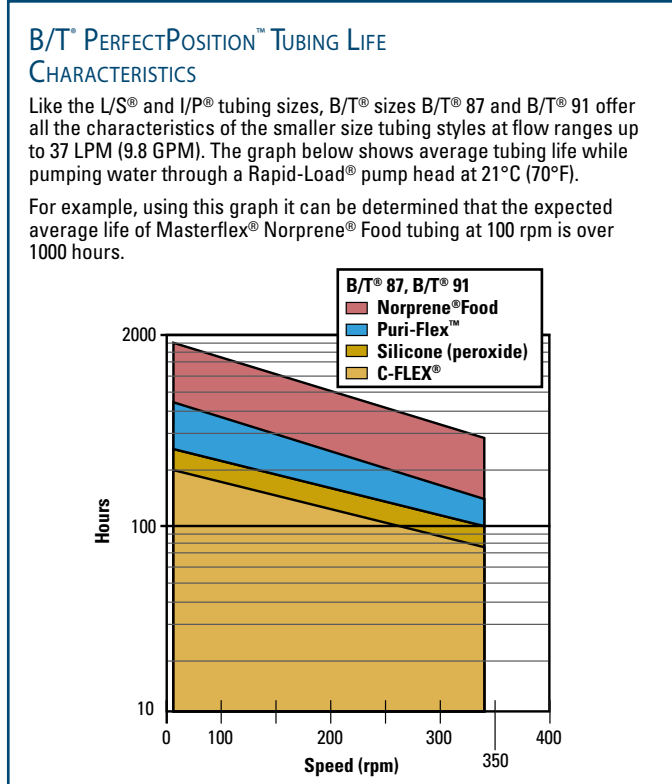
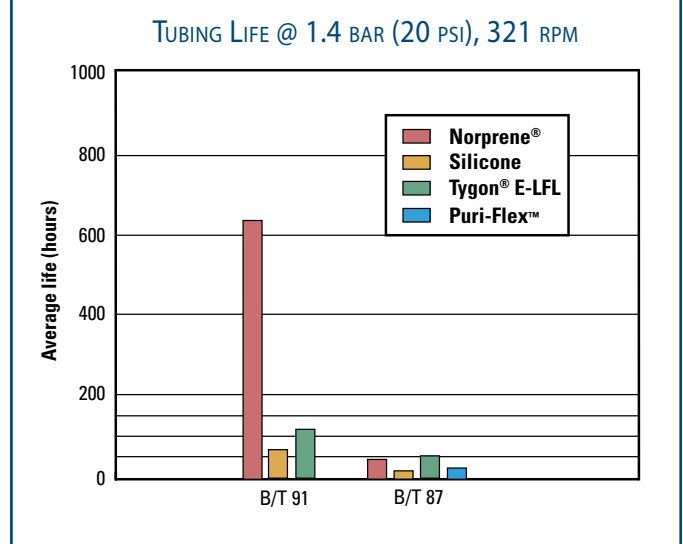
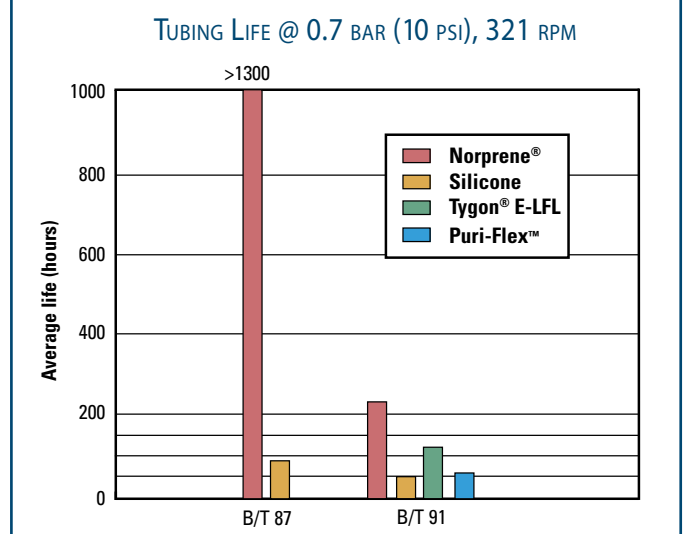
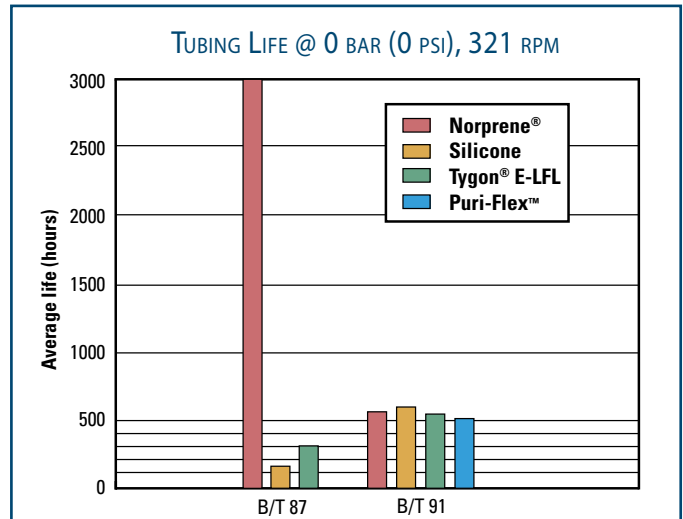
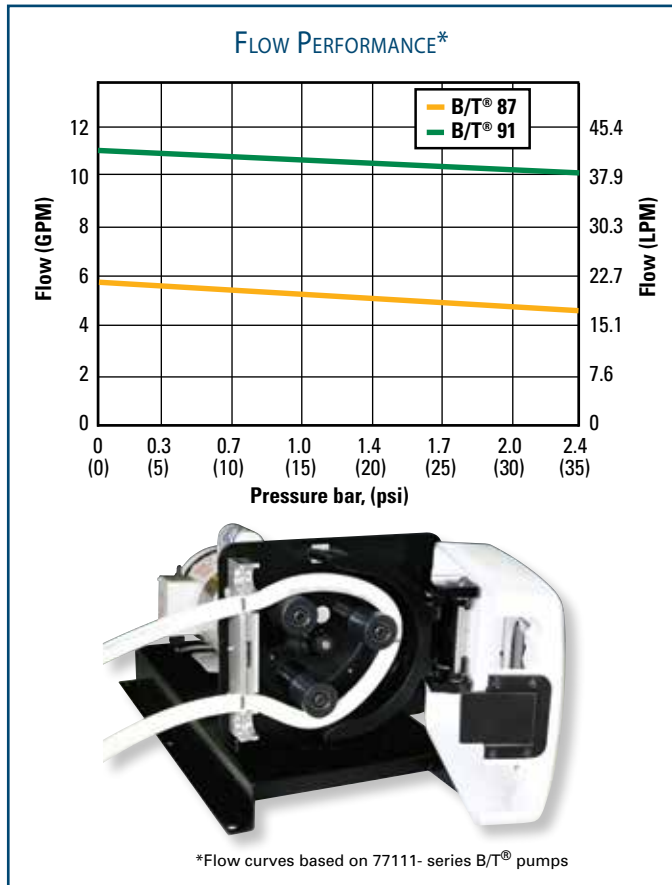

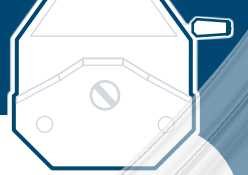

## MASTERFLEX® TUBING PUMP FLOW PERFORMANCE

C/L® PUMP (77120-32, -52)

6 rpm @ 0 bar (0 psi)

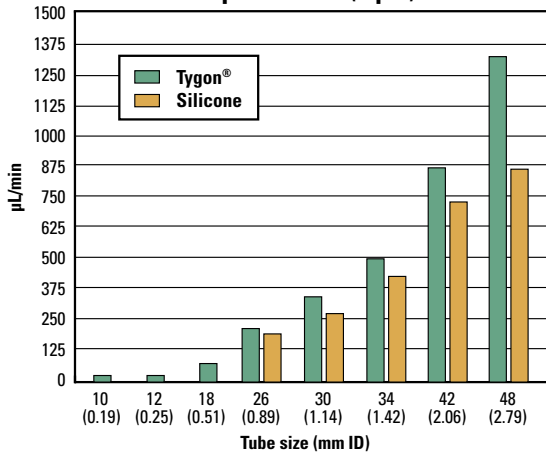

C/L® PUMP (77120-42, -62)

60 rpm @ 0 bar (0 psi)

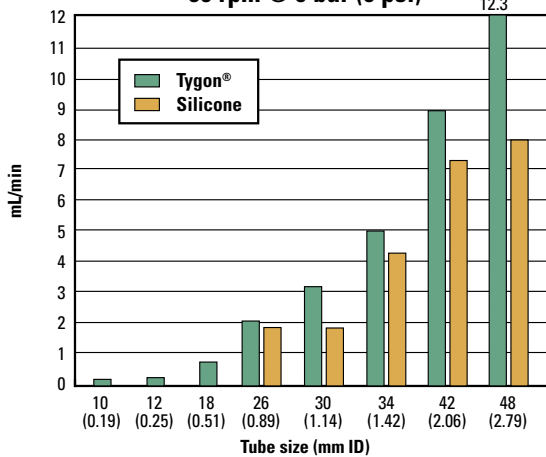

C/L® PUMP (77122-24, -26)

300 rpm @ 0 bar (0 psi)

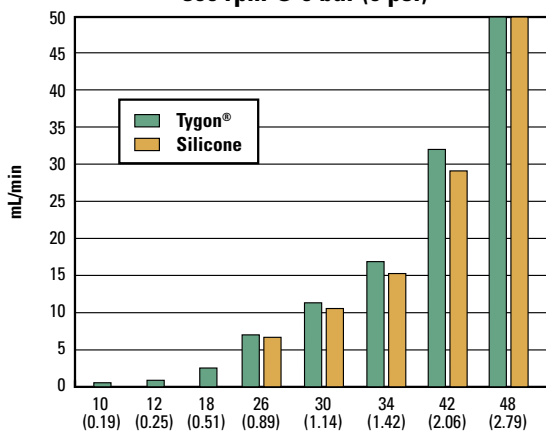

### FLOW RATES

Masterflex® offers a wide range of pump systems and tubing sizes. These graphs are designed to help you select a size for your application.

Pressure, in general, does not affect the flow rate of the pump head and tubing combination in water applications, unless the pressure exceeds the rating for continuous duty operation. At pressures above this rating to the maximum, the flow rates will drop off.

The exact flow rates will vary from application to application depending on the tubing material and occlusion.

L/S® PTFE TUBING PUMP (77390-series)

Flow measurements taken at one hour running; pumping water @ 21°C (70°F), 300 rpm

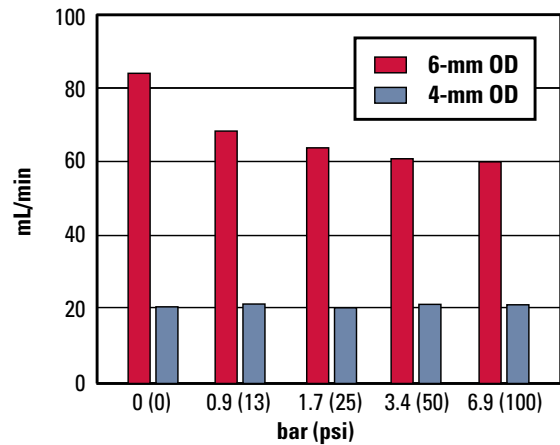

### TUBING MEAN TIME TO FAILURE (MTTF)

L/S® PTFE Pump 77390-00 @ 300 rpm, 0 psi

Parametric: 500 hours at 100 rpm  
Catastrophic: 1500 hours at 100 rpm

Approximate Flow Decay

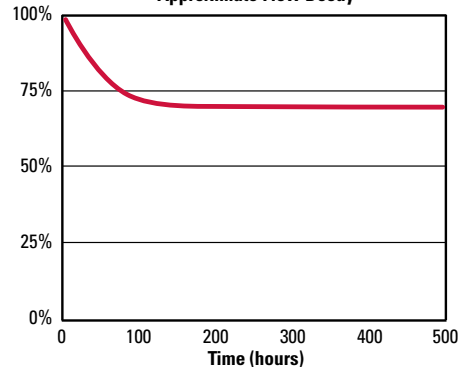

## MASTERFLEX® TUBING PUMP FLOW PERFORMANCE

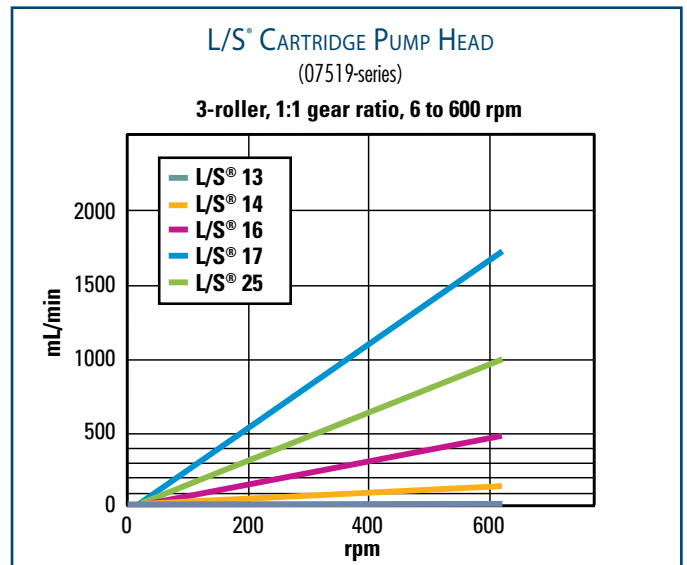
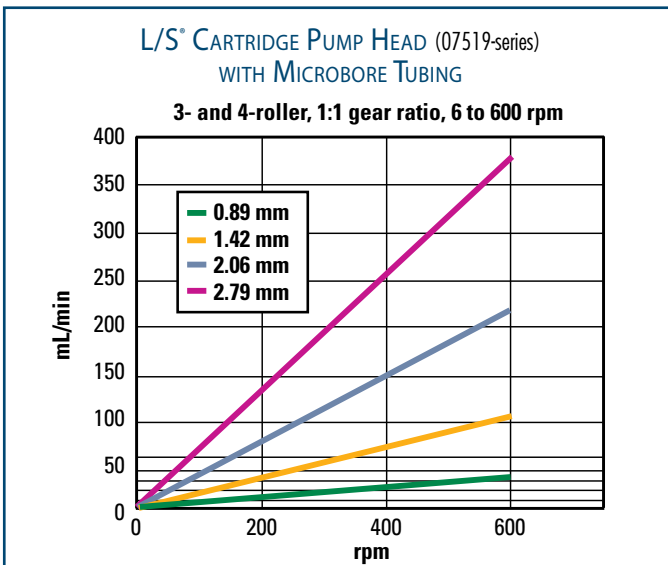
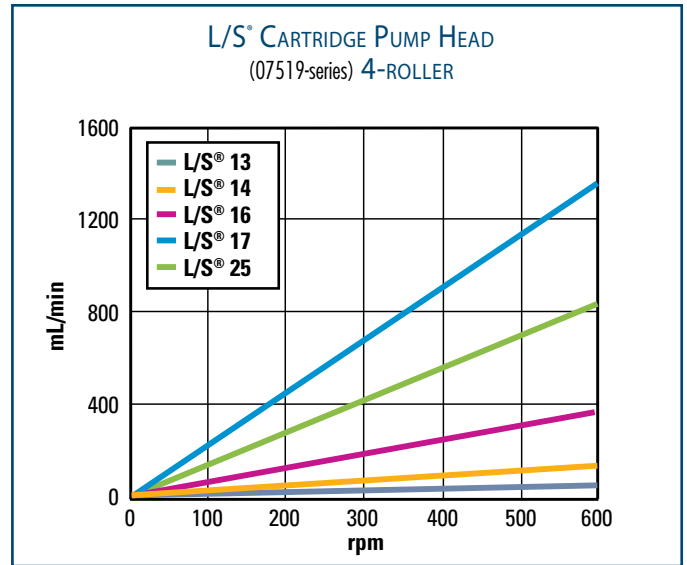
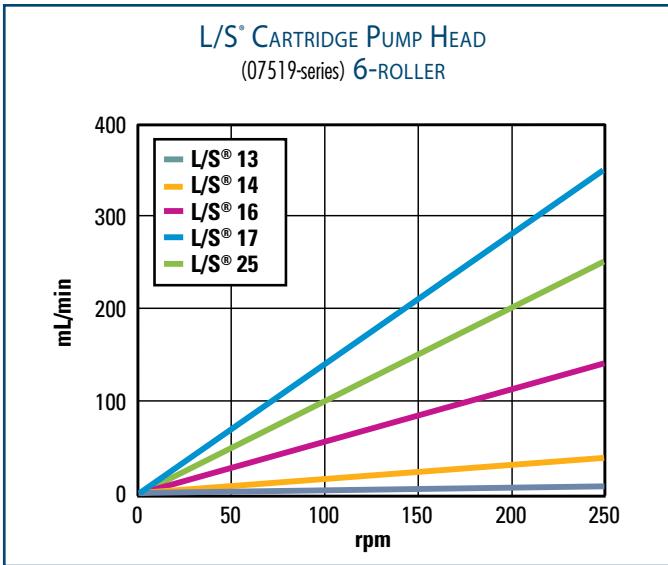
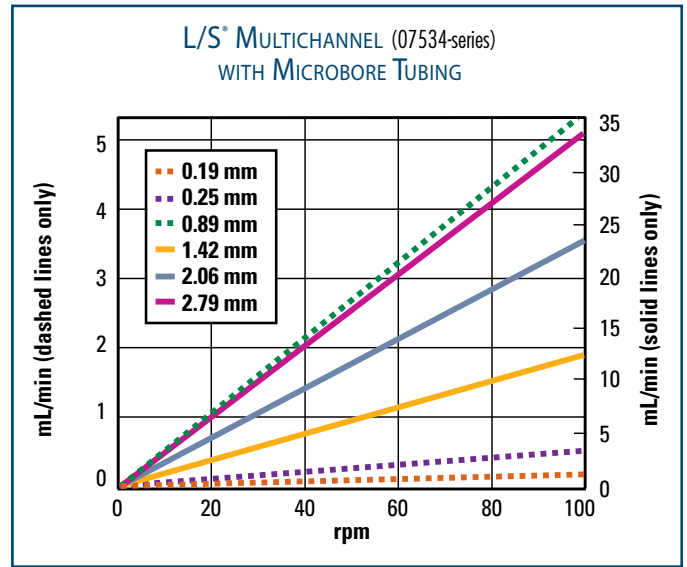
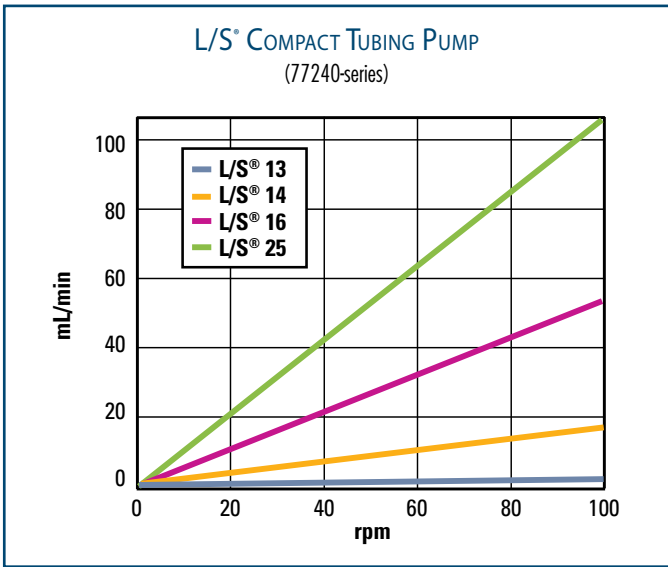



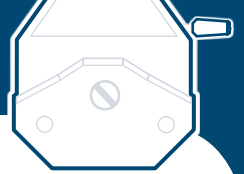

**L/S® MULTICHANNEL**  
(07535-, 07536-series)

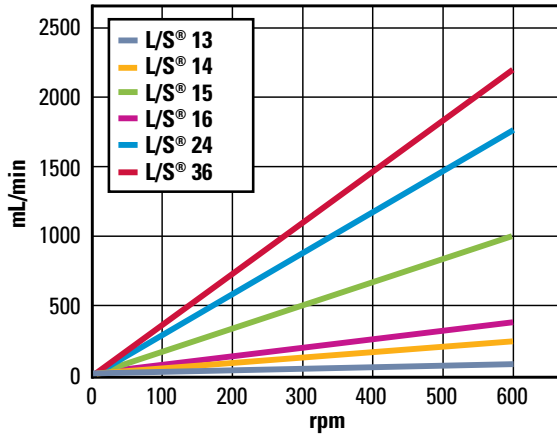

**L/S® STANDARD (070XX-series),  
EASY-LOAD® (07518-series), EASY-LOAD® II (77200-,  
77201-series), AND EASY-LOAD® 3 (77800-series)**

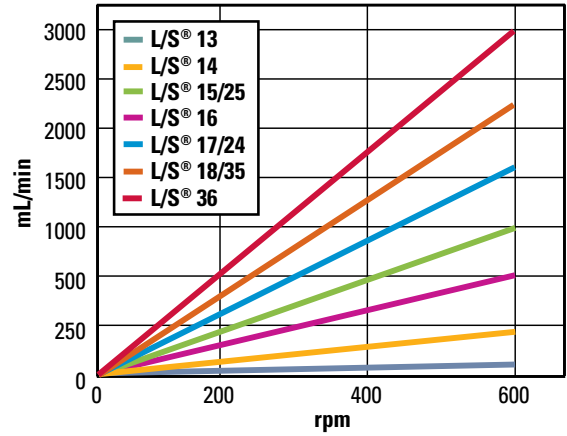

**L/S® HIGH-PERFORMANCE PUMP HEAD**  
(77250-62, -82)

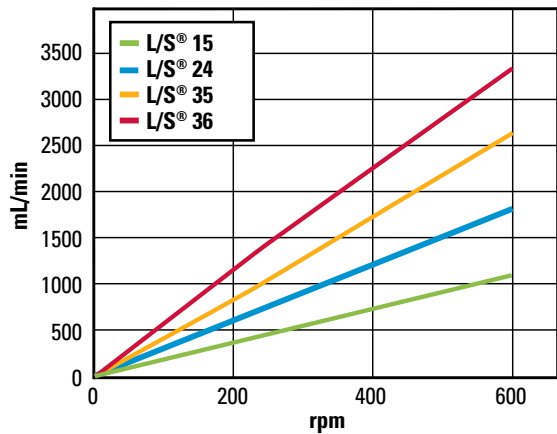

**I/P® STANDARD (07019-series)  
AND EASY-LOAD® (77601-series)**

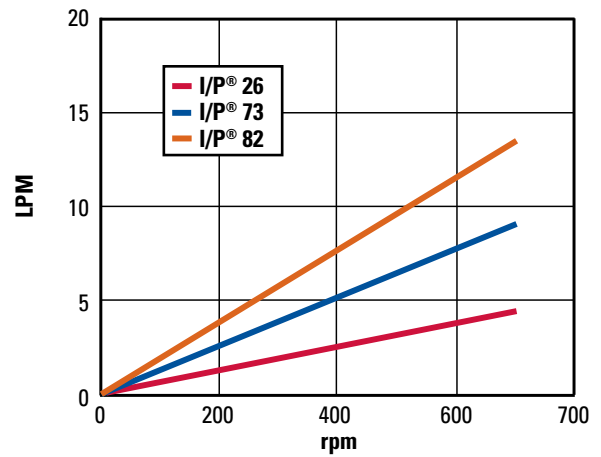

**I/P® HIGH-PERFORMANCE PUMP HEAD**  
(77600-62, -82)

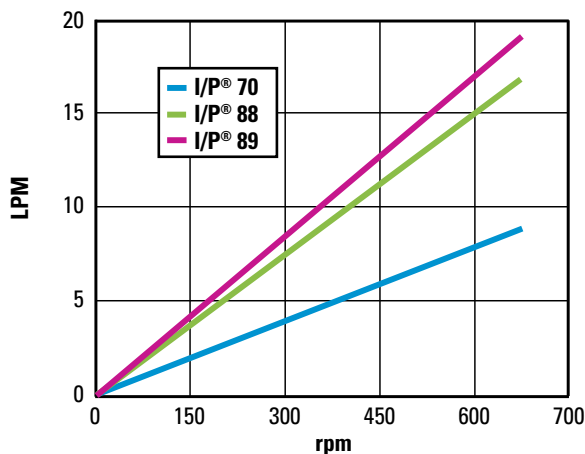

**B/T® PUMP HEAD**  
(77111-series)

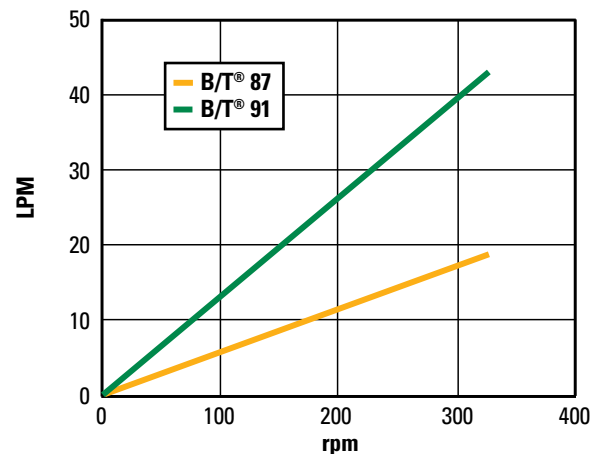

## PUMP HEAD FLOW CURVES

### L/S® STANDARD PUMP HEAD

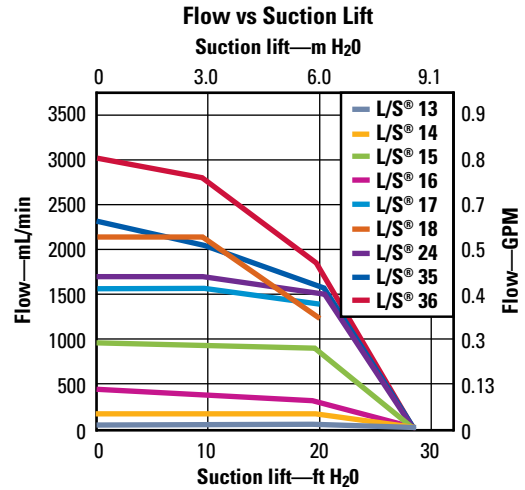
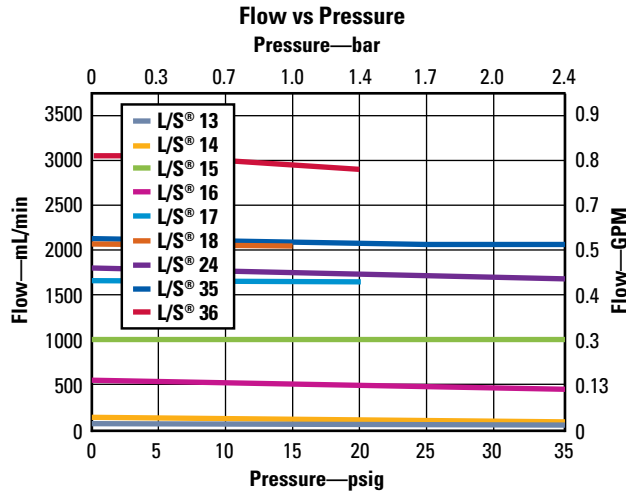

### L/S® EASY-LOAD®, EASY-LOAD® II, AND EASY-LOAD® 3 PUMP HEAD

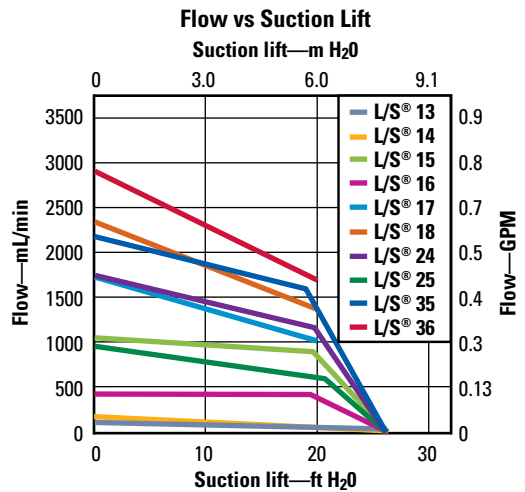
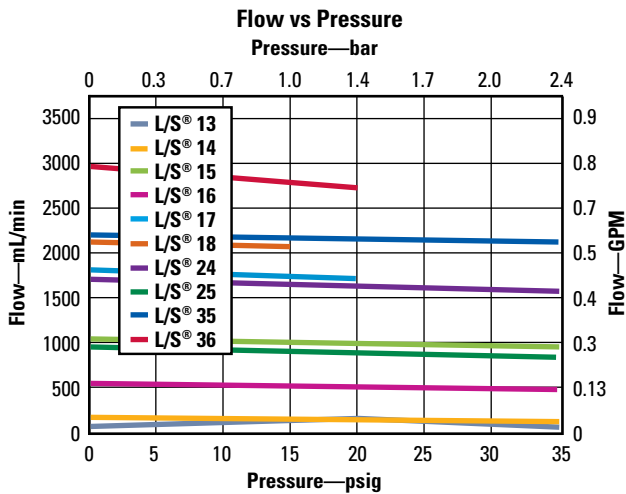

### L/S® HIGH-PERFORMANCE PUMP HEAD

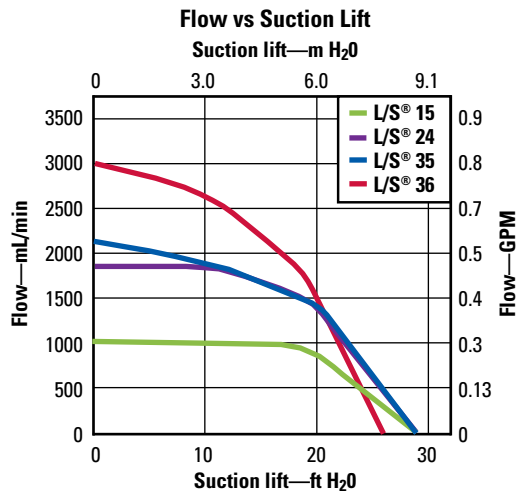
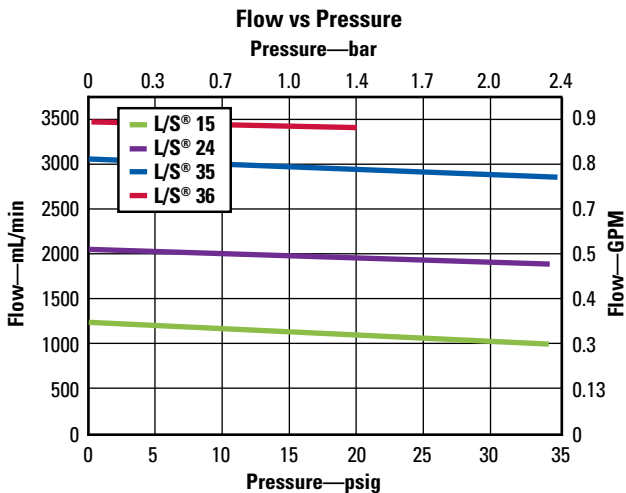

**Note:** Pressure curves developed with zero to one foot suction lift. Suction lift curves developed with zero discharge pressure. Pump speed: 650 rpm. Fluid: water at ambient temperature.

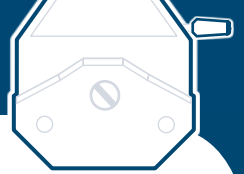

### I/P<sup>®</sup> STANDARD PUMP HEAD

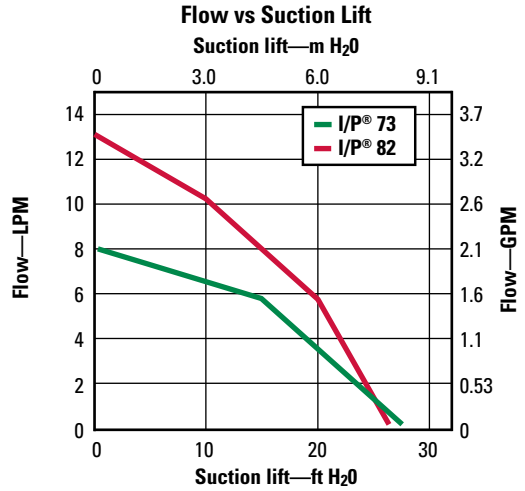
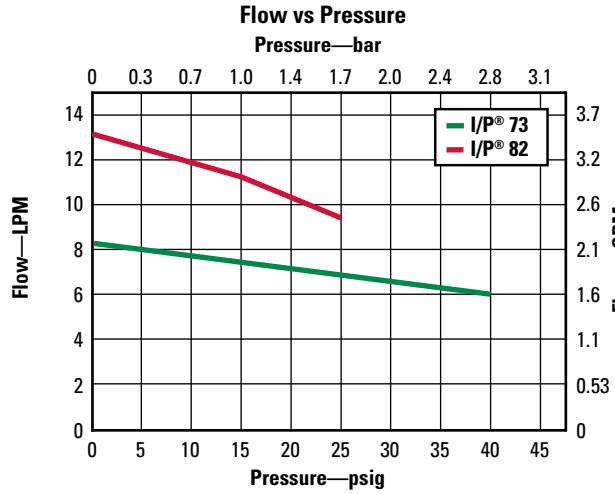

### I/P<sup>®</sup> EASY-LOAD<sup>®</sup> PUMP HEAD

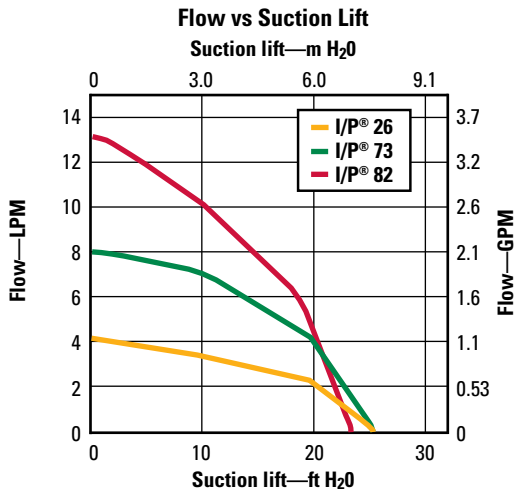
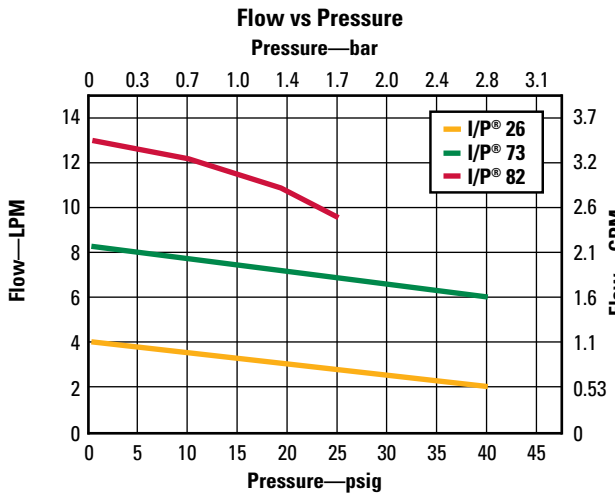

### I/P<sup>®</sup> HIGH-PERFORMANCE PUMP HEAD

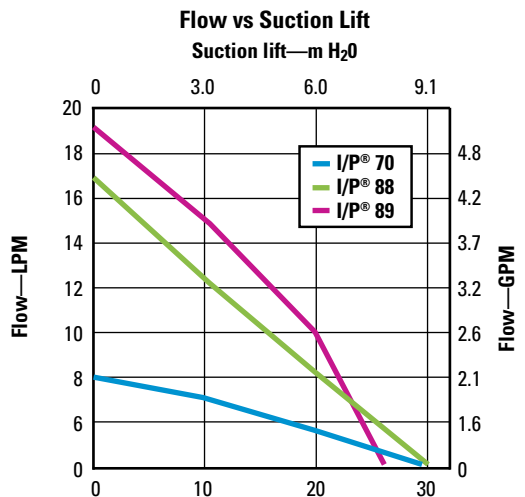
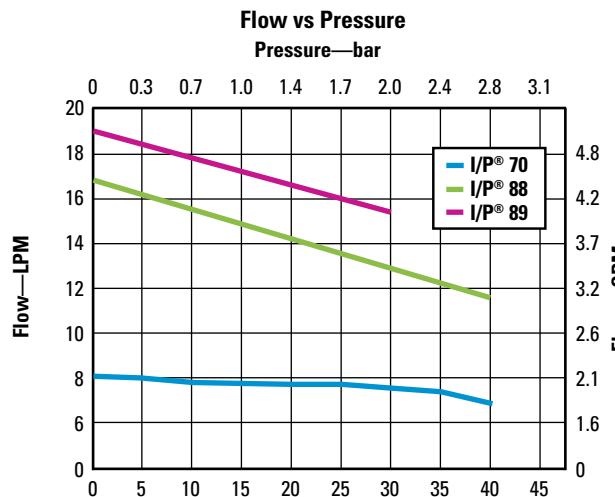

**Note:** Pressure curves developed with zero to one foot suction lift. Suction lift curves developed with zero discharge pressure. Pump speed: 650 rpm. Fluid: water at ambient temperature.

## PUMP HEAD TORQUE REQUIREMENTS

### HOW TO USE THESE TABLES

Use this guide to help you select the number of pump heads and tubing formulations that can be used with your drives.

To define your torque needs:

1. Consider the following:
  - ▶ Discharge pressure (increase necessary torque)
  - ▶ Tubing material (firm or soft)
2. Multiply by the number of pump heads you would like to use (to run two heads with the same size and formulation of tubing, multiply the value from the table by 1.9). See example at right.
3. See drive specifications for maximum torque limits. (Consider starting torque when selecting a drive.) The torque of the drive must exceed the starting torque value for the pump head/tubing combination. Note: starting torque is equal to approximately three times (3x) maximum running torque for drives of 75 W (1/10 hp) or greater.

4. Several factors influence starting torque:

- ▶ New or used tubing
- ▶ Tubing formulation
- ▶ Length of time tubing has been in closed pump head without running
- ▶ Temperature
- ▶ Pressure

### EXAMPLE

Using one Easy-Load® II pump head with L/S® 15 Norprene® tubing requires a drive capable of supplying at least 81.1 N-cm (115 oz-in.) of starting torque.

When using two Easy-Load® II pump heads with L/S® 15 Norprene® tubing, you will need a drive capable of supplying 154 N-cm (218 oz-in.) of starting torque.

### STARTING TORQUE USING THE L/S® AND I/P® STANDARD PUMP HEAD

Tubing size	C-FLEX® / Silicone		BioPharm Plus silicone		Viton®		Tygon® E-Lab		Tygon® E-LFL		Tygon® E-Food / Tygon® Fuel & Lubricant		Tygon® Chemical		Chem-Durance® Bio		Norprene® / Puri-Flex™ / PharMed® BPT / C-Flex® ULTRA		PharmaPure®		GORE® Style 100SC	
	N-cm	oz-in	N-cm	oz-in	N-cm	oz-in	N-cm	oz-in	N-cm	oz-in	N-cm	oz-in	N-cm	oz-in	N-cm	oz-in	N-cm	oz-in	N-cm	oz-in	N-cm	oz-in
<b>L/S® Precision pump tubing</b>																						
L/S 13	7.7	11	9.2	13	11.3	16	22.5	32	17	24	42.3	60	—	—	—	—	19.8	28	—	—	NA	NA
L/S 14	9.9	14	11.3	16	13.4	19	49.4	70	22.5	32	84.7	120	—	—	—	—	25.3	36	—	—	81.1	115
L/S 16	18.3	26	18.3	26	15.5	22	70.6	100	51.5	73	81.1	115	—	—	—	—	52.9	75	—	—	88.2	125
L/S 17	26.9	38	33.9	48	45.9	65	105.8	150	77.6	75	127	180	—	—	—	—	116.4	165	—	—	226	320
L/S 18	42.3	60	38.8	55	60	85	91.7	130	70.6	90	180.6	256	—	—	—	—	169.3	240	—	—	305	432
<b>L/S® High-performance Precision pump tubing</b>																						
L/S 15	24	34	35.3	50	21.2	30	105.8	150	70.6	115	225.8	320	—	—	—	—	91.7	130	—	—	91.7	130
L/S 24	42.3	60	98.8	140	64.9	92	127	180	98.8	140	316.1	448	—	—	—	—	135.4	192	—	—	120	170
L/S 35	41.7	59	50.8	72	113	160	151	214	113	160	304.8	432	—	—	—	—	152.4	216	—	—	124.2	176
L/S 36	49.4	70	77.6	110	147	208	140	198	113	160	—	—	—	—	—	—	169.3	240	—	—	NA	NA
<b>I/P® Precision pump tubing</b>																						
I/P 73	90.4	128	124.2	176	137.6	195	225.8	320	147	208	548	776	—	—	—	—	214.5	304	—	—	226	320
I/P 82	77.6	110	203.4	288	NA	NA	338.7	480	135.4	192	678	960	—	—	—	—	225.8	320	—	—	452	640

### STARTING TORQUE USING L/S® AND I/P® EASY-LOAD® AND EASY-LOAD® II PUMP HEADS

Tubing size	C-FLEX® / Silicone		BioPharm Plus silicone		Viton®		Tygon® E-Lab		Tygon® E-LFL		Tygon® E-Food / Tygon® Fuel & Lubricant		Tygon® Chemical		Chem-Durance® Bio		Norprene® / Puri-Flex™ / PharMed® BPT / C-Flex® ULTRA		PharmaPure®		GORE® Style 100SC	
	N-cm	oz-in	N-cm	oz-in	N-cm	oz-in	N-cm	oz-in	N-cm	oz-in	N-cm	oz-in	N-cm	oz-in	N-cm	oz-in	N-cm	oz-in	N-cm	oz-in	N-cm	oz-in
<b>L/S® Precision pump tubing</b>																						
L/S 13	7.7	11	9.2	13	12	17	21.2	30	12	17	56.4	80	17	24	21.2	30	14.1	20	20.5	29	NA	NA
L/S 14	11.3	16	12.7	18	16.3	23	31.8	45	19	27	63.5	90	35.3	50	35.3	50	28.2	40	27.5	39	24.7	35
L/S 16	11.3	16	13.4	19	24.7	35	38.8	55	42.4	60	63.5	90	45.9	65	56.4	80	31.8	45	63.5	90	63.5	90
L/S 25	21.2	30	45.9	65	21.2	30	60	85	35.3	50	52.9	75	63.5	90	84.7	120	35.3	50	50.8	72	91.7	130
L/S 17	24.7	35	36	51	35.3	50	56.4	80	61.4	87	84.7	120	45.9	65	84.7	120	84.7	120	70.6	100	42.3	60
L/S 18	35.3	50	38.8	55	52.9	75	70.6	100	35.3	50	84.7	120	52.9	75	113	160	84.7	120	91.7	130	70.6	100
<b>L/S® High-performance Precision pump tubing</b>																						
L/S 15	45.9	65	49.4	70	45.9	65	88.2	125	77.6	110	197.6	280	—	—	113	160	81.1	115	77.6	110	70.6	100
L/S 24	38.8	55	49.4	70	74.1	105	95.3	135	70.6	100	208.2	295	192	272	119.9	170	84.7	120	113	160	49.4	70
L/S 35	56.4	80	60	85	77.6	110	98.8	140	70.6	100	192	272	—	—	124.1	176	124.2	176	—	—	91.7	130
L/S 36	49.4	70	77.6	110	70.6	100	113	160	105.8	150	214.5	304	—	—	135.3	192	109.4	155	—	—	NA	NA
<b>I/P® Precision pump tubing</b>																						
I/P 76	113	160	113	160	—	—	203.2	288	147	208	248.3	352	327.4	464	—	—	180.6	256	226	320	127	180
I/P 73	169.3	240	169.3	240	192	272	316.1	448	180.6	256	481.9	683	282.2	400	304.6	432	316.1	448	248.3	352	192	272
I/P 82	180.6	256	192	272	NA	NA	304.8	432	225.8	320	474.1	672	395.1	560	429.3	608	282.2	400	338.7	480	338.7	480

NA = Not available or applicable

— Not recommended

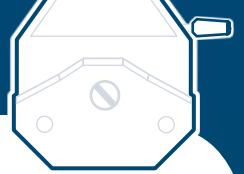

## HOW TO USE THIS TABLE

Use this guide to help you select the number of pump heads and tubing formulations that can be used with your drives.

To define your torque needs:

1. Consider the following:
  - ▶ Discharge pressure (increase necessary torque)
  - ▶ Tubing material (firm or soft)
2. See drive specifications for maximum torque limits. (Consider starting torque when selecting a drive.) The torque of the drive must exceed the starting torque value for the pump head/tubing combination. Note: starting torque is equal to approximately three times (3x) maximum running torque.
3. Several factors influence starting torque:
  - ▶ New or used tubing
  - ▶ Tubing formulation
  - ▶ Length of time tubing has been in closed pump head without running
  - ▶ Temperature
  - ▶ Pressure

### EXAMPLE

Using one High-Performance pump head with L/S® 15 Norprene® tubing requires a drive capable of supplying at least 105.8 N-cm (150 oz-in) of starting torque.

## STARTING TORQUE USING THE L/S® AND I/P® HIGH-PERFORMANCE PUMP HEADS

Tubing size	C-FLEX® / Silicone		BioPharm Plus silicone		Viton®		Tygon® E-Lab		Tygon® E-LFL		Tygon® E-Food / Tygon® Fuel & Lubricant		Tygon® Chemical		Chem-Durance® Bio		Norprene® / Puri-Flex™ / PharMed® BPT / C-Flex® ULTRA		PharmaPure®		GORE® Style 100SC		
	N-cm	oz-in	N-cm	oz-in	N-cm	oz-in	N-cm	oz-in	N-cm	oz-in	N-cm	oz-in	N-cm	oz-in	N-cm	oz-in	N-cm	oz-in	N-cm	oz-in	N-cm	oz-in	
<b>L/S® High-pressure pump tubing</b>																							
L/S 15HP†	NA	NA	NA	NA	NA	NA	NA	NA	NA	NA	NA	NA	NA	NA	NA	NA	NA	428.9	608	NA	NA	NA	NA
L/S 16HP†	NA	NA	NA	NA	NA	NA	NA	NA	NA	NA	NA	NA	NA	NA	NA	NA	NA	496.7	704	NA	NA	NA	NA
<b>L/S® High-performance Precision pump tubing</b>																							
L/S 15	35.3	50	56.4	80	70.6	100	127	180	84.7	120	271	384	—	—	—	—	105.8	150	—	—	123.5	175	
L/S 24	35.3	50	63.5	90	91.7	130	120	170	77.6	110	282.2	400	—	—	—	—	120	170	—	—	180.5	256	
L/S 35	52.9	75	64.9	92	84.7	120	158.1	224	98.8	140	—	—	—	—	—	—	124.2	176	—	—	225.8	320	
L/S 36	52.9	75	77.6	110	105.8	150	146.7	208	112.9	160	—	—	—	—	—	—	135.4	192	—	—	NA	NA	
<b>I/P® High-performance Precision pump tubing</b>																							
I/P 26‡	226	320	248.3	352	NA	NA	338.7	480	316.1	448	—	—	—	—	485.8	688	496.7	704	—	—	237.1	336	
I/P 73‡	180.6	256	237.1	336	NA	NA	—	—	259.6	368	—	—	—	—	575.3	816	428.9	608	—	—	338.7	480	
I/P 82‡	158.1	224	180.6	256	NA	NA	361.2	432	259.6	368	—	—	—	—	564.5	800	451.6	640	—	—	406.4	576	

† Can only be used and started on a 100 rpm drive    ‡ Starting torque based on notch #1.    NA = Not available or applicable    — Not recommended

### TORQUE SPECIFICATIONS FOR L/S® PTFE-DIAPHRAGM PUMP HEAD

Catalog number	HL-07090-62		HL-07090-42	
Discharge pressure	0 bar (0 psi)		0 bar (0 psi)	
Start	56.8 N-cm (80 oz-in)		127.4 N-cm (180 oz-in)	
Average	21.2 N-cm (30 oz-in)		24.5 N-cm (35 oz-in)	
Peak	31.8 N-cm (45 oz-in)		63.5 N-cm (90 oz-in)	



## DRIVE TORQUE REQUIREMENTS TO OBTAIN 19 LPM WITH I/P® HIGH-PERFORMANCE PUMP HEADS

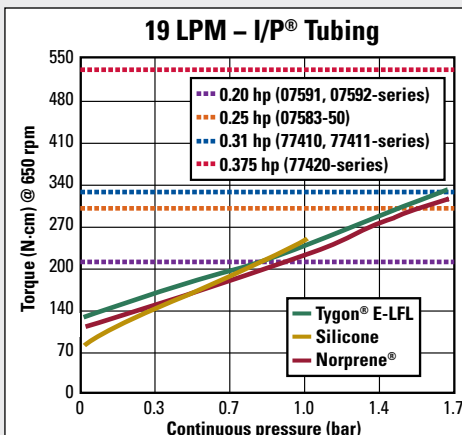

Choose your drive based on desired flow rate, pressure in your application, and type of tubing used. For example, if you need 19 LPM at 1.4 bar and are using Norprene® tubing, you need a drive that supplies 0.25 hp (07583-50).

Some flow rate/pressure combinations are not possible with all drives. High-performance pump head is designed exclusively for use with High-performance Precision tubing.



High-Performance pump head 77600-62. Order on pages 126–127.

## TIPS FOR DISPENSING APPLICATIONS

Masterflex® digital pump drives are ideal for laboratory and process dispensing applications. Accuracies of  $\pm 0.5\%$  and better are achievable with careful pump system selection and by following some simple guidelines.

### DISPENSING BENEFITS OF MASTERFLEX® TUBING PUMPS

- ▶ Variety of available tubing formulations ensures chemical and biocompatibility with your fluid
- ▶ A continuous piece of tubing from inlet to outlet minimizes obstructions and interruptions in the fluid path
- ▶ Gentle pumping action is ideal for shear-sensitive fluids and fluids containing proteins and other large molecules
- ▶ Wide range of flow rates provides flexibility in volume and time of dispense
- ▶ Simple and reliable calibration ensures accuracy and repeatability
- ▶ Nonsiphoning; prevents backflow and enhances dispensing accuracy
- ▶ Multichannel capability with synchronous or independently controlled channels

### PUMP HEAD SELECTION

Masterflex® Standard, Easy-Load®-series, and High-performance pump heads all deliver excellent results in dispensing applications.

#### Multichannel Options

Three types of pump head adapt easily to multichannel applications: stackable single-channel heads, multichannel heads, and cartridge heads. Multichannel and cartridge heads provide for the maximum number of tubing channels within a relatively small space.

#### Stackable Single-Channel Pump Heads

You can add or remove stackable single-channel heads as needed for different applications. Stackable pump heads are therefore popular for applications that require the flexibility to frequently reconfigure the pump design. Stackable heads are preferred for larger tubing sizes, and when the application involves high suction lift and/or discharge pressure.

Two or four stacked heads can typically be mounted on a drive depending on the drive's speed range and horsepower. The dual channel Masterflex® L/S® Easy-Load® II pump head can give you up to 8 channels with four heads stacked on a single drive.

#### Multichannel Pump Heads

Multichannel heads are a second option for multiple channel applications. These heads combine many of the best features of both cartridge heads and stacked single-channel heads.

These heads offer relatively low pulsation flow from two, four, or eight channels with no cartridges. They are also stackable for up to 32 channels depending on tubing size and formulation and drive power. Between-channel flow is synchronous with no adjustment of occlusion. These features give multichannel heads the configuration flexibility of stacked single-channel heads, as well as the synchronous flow and channel capacity of cartridge heads.

Masterflex® L/S® multichannel pump heads are available for microbore tubing and for Masterflex® L/S® tubing sizes.

### REDUCED PULSATION

Minimal pulsation is essential to ensuring accuracy in peristaltic dispensing. Pulsation causes variations in flow rate and splashing and frothing in the receiving vessel. Combining the split-channel tubing configuration with the offset rollers of two stacked Easy-Load® II pump heads merges a pulse from one channel with a trough from the other. The reduced pulsation is measured at the outlet and shown in the graph at right.

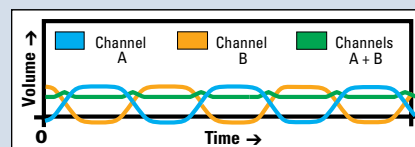

### Cartridge Pump Heads

Cartridge pump heads accept a predetermined maximum number of channels—any number of these channels can be used, up to the capability of the head and the drive. Masterflex® L/S® cartridge heads can be mounted on most Masterflex® L/S® drives. Up to 12 individual channels mount on a single head with flow rates as low as 0.0005 mL/min per channel.

Cartridge pumps have long rollers that provide synchronous fluid delivery between the cartridges. These pump heads also have a higher number of rollers than single-channel heads, which results in lower pulsation flow and higher accuracy at low volumes and low flow rates. These pumps are recommended for low volume/low flow rate fluid transfer applications.

Cartridge heads with adjustable occlusion offer the highest between-channel accuracy of all pump head types. Fine adjustments to the occlusion in individual channels can effectively compensate for any minor variations in tubing dimensions that lead to slight variations in flow.

### Accuracy

Cartridge and multichannel pump heads are popular for accurate sampling, dispensing, and metering of fluids. The synchronous rollers provide coordinated fluid delivery between each channel in the pump head. Multichannel heads deliver between-channel flow accuracies in the range of 1.5 to 2% (depending on tubing formulation). With adjustable occlusion, cartridge pump heads can deliver flow accuracies of <1% between channels. Precise dispensing and metering require this high level of performance and accuracy.

## FREE TECHNICAL APPLICATIONS ASSISTANCE

Our team of **scientific experts** is trained to answer your most **challenging questions** because they are **experienced** in a wide variety of backgrounds, including **biology, chemistry, biochemical engineering, and physics**.



For answers, call our  
**APPLICATION SPECIALISTS**

**CHALLENGE:** A pharmaceutical manufacturer needed to dispense volumes of 300 mL in 15 seconds or less repeating three times per minute; and 20 mL in 2 seconds or less repeating 20 times per minute. The desired accuracy target for both applications was  $\pm 1.5\%$ . The efficiency of simultaneously pumping multiple channels was critical.

**OUR SOLUTION:** The manufacturer now uses a Masterflex® L/S® digital drive 07522-20 (see pages 88–89) with an L/S four-channel pump head 07536-04 (see pages 54–55). Size L/S 15 two-stop BioPharm Plus silicone tubing (96116-15) met the smaller flow requirement; while size L/S 35 two-stop BioPharm Plus silicone tubing (96116-35) met the larger flow requirement. BioPharm Plus silicone tubing is recommended for high-accuracy dispensing applications due to its exceptional flow stability over time. Careful calibration of the drive and the synchronous multichannel flow capability of the pump head enabled the manufacturer to meet the accuracy target.

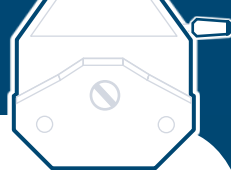

## TUBING SELECTION

### Chemical Compatibility

Refer to the chemical compatibility charts specific to pump tubing on pages 30–31. These charts are compiled from actual test data in peristaltic pumps.

### Temperature Sensitivity

The friction caused by the rollers moving over the tubing will generate measurable heat. This heat generation can affect the mechanical properties of the tubing and result in slight variations in performance. PVC-based formulations show the most pronounced temperature sensitivity. Due to minimal temperature sensitivity, recommended formulations for dispensing applications are BioPharm Plus silicone, PharMed® BPT, PharmaPure®, Norprene®, and GORE® Style 100SC. BioPharm Plus tubing has characteristics that make it ideal for dispensing: superior shape memory throughout its life in the pump, little cross-sectional distortion over time, and minimal variation in flow over time. This superior shape memory is sufficient to offset the need for an initial break-in period.

### Size/Flow Range

Size your tubing so that you are operating at the middle of the tubing's flow range (volume per unit time). This will give you maximum flexibility to make adjustments without approaching either the upper or lower limit of the tubing flow range.

### Loading the Tubing in the Pump Head

You will realize optimal performance, and best pumping life, if you are careful not to impart any twist or torsion to the tubing when loading. Tubing has a natural curvature—follow that curvature when laying the tubing across rollers or onto occlusion bed.

### Tubing Break-In Period

Peristaltic pump tubing shows a distinct increase in flow stability after the first few minutes of pumping. During this break-in period the tubing adapts to the repeated compression of the rollers. For tubing in the L/S® sizes the break-in period is 10 to 15 minutes; for I/P® tubing sizes 12 to 18 minutes.

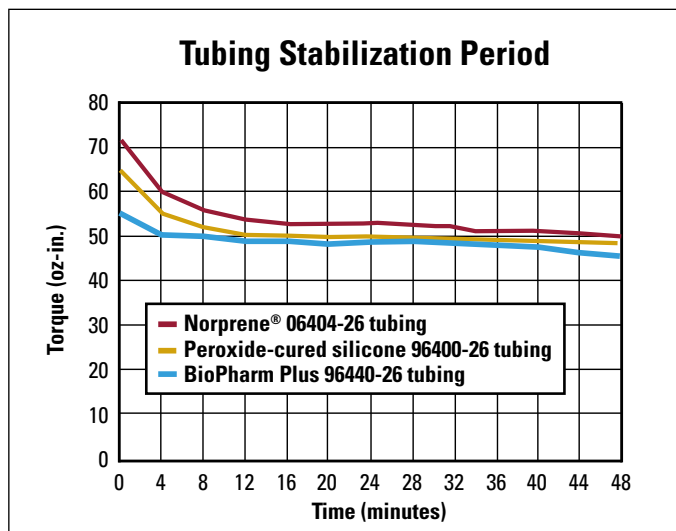

### Tubing Dimensions and Tolerances

Masterflex drives, pump heads, and pump tubing have all been co-designed, and are continually being monitored and refined, to deliver best performance when used together in complete pump systems. The exact dimensions and manufacturing tolerances of the tubing have direct impacts on maximizing tubing life and dispensing accuracy.

The flow rate for a given size of tubing is derived from the volume pumped per each revolution of the rollers. Volume pumped per revolution is directly proportional to the inside diameter of the tubing. Even slight variations in inside diameter can have significant impact on flow accuracy. Variations in the outside diameter of the tubing can result in the tubing not being properly retained in the pump head and being either over- or under-occluded. These

problems can also impact accuracy as well as tubing life. Masterflex pump tubing is manufactured to very precise tolerances and monitored and tested to verify those tolerances. To realize the maximum accuracy and repeatability from your Masterflex pump drive, we strongly recommend that you use only Masterflex pump tubing.

### Regulatory Classifications for Tubing

Several Masterflex tubing formulations comply with industry-critical regulations. Relevant classifications include those specified by the United States Pharmacopoeia (USP), European Pharmacopoeia (EP), US Food and Drug Administration (FDA), U.S. Department of Agriculture (USDA) and National Sanitation Foundation (NSF).

Upon request, Cole-Parmer will provide you with a certificate validating that the tubing is in compliance with a particular regulation. This documentation will ensure that you can demonstrate compliance with your individual protocols.

## DRIVE SELECTION

Masterflex systems offer digital drives with features designed for dispensing applications. Drives are available in console, modular, and modular washdown configurations.

### Dispense Features

- Dispense by volume—lets you program the volume to be dispensed for either single or multiple cycles
- Dispense by time—allows you to run the pump at a programmed flow rate for a specified period of time
- Copy—lets you program the number of dispense cycles or repeats.
- Dispense interval—an adjustable time delay between cycles, gives you ample time to reposition the tubing or filling accessory or to switch target vessels
- Batch count—this feature allows you to program a defined number of batches; as the pump operates, the number of batches completed is displayed alongside the programmed total
- Cumulative volume—displays the total volume dispensed over multiple cycles
- Dispense by weight—requires an RS-232 or balance-compatible interface (available on the L/S 07551-00 and -10 Computer-Compatible drive and on the L/S Digi-Staltic® modular dispensing pump)
- Antidrip feature—briefly reverses the rollers at the end of the dispense cycle, further ensuring accuracy (available on the L/S Digi-Staltic modular dispensing pump)



### Remote Control

Remote control options enable easy integration of pumps into automated systems and also enhance user comfort in repetitive dispensing applications. Controllable functions include start/stop, reverse, prime, dispense or copy, and speed. Drives are available with analog (DC voltage, current, or contact closure) and/or digital (RS-232, USB) interfaces. Control accessories include foot switches and dispensing wands for momentary start/stop and a full-function handheld remote controller for selected drives.

### Calibration

Proper calibration is essential to dispensing accuracy. Follow the directions in the drive operating manual and perform no more than two or three successive calibrations. Masterflex® digital dispensing drives store one calibration value per tubing size and will hold that value in memory until the pump is recalibrated for that particular tubing size. Calibration conditions should be identical to the actual dispensing conditions. Backpressure, fluid viscosity, and temperature should not vary from calibration throughout dispensing. Remember to break in the tubing for the described period (see above) before calibration.

## PUMPING ABRASIVE FLUIDS

Masterflex® tubing pumps are well suited for pumping abrasive slurries for several reasons. The peristaltic pumping action is gentle on the fluid, reducing tubing wear. The only part of the pump the fluid comes in contact with is a smooth piece of tubing; there are no fittings or valves that particles may clog. Abrasive materials shorten the life of any pump, but with peristaltic pumps the tubing is quickly and inexpensively replaced.

Follow these suggestions to get the maximum performance from your peristaltic tubing pump:

- 1. Choose abrasion-resistant tubing.** Norprene® and PharMed® BPT have good abrasion resistance. Tygon® is fair with abrasives, while C-FLEX®, silicone, and Viton® are moderately resistant to wear from abrasive materials.
- 2. Use an adjustable-occlusion pump head.** The standard occlusion for all Masterflex® fixed-occlusion pump heads is shown in Figure A. Abrasive materials, especially hard particles, are pressed into the tubing wall and can cause a great amount of wear. Using an adjustable-occlusion pump head allows you to reduce the amount that the tubing is squeezed (Figure A); the result is less wear on the tubing. By increasing the occlusion to prime the tubing and then reducing it to pump, you'll get maximum performance from your pump with the least amount of wear on the tubing.
- 3. Select a larger tubing size.** This will reduce the rate that particles come into contact with the tubing wall. Soft particles should have an ID less than 25% of the ID of the tubing. Hard particles should be even smaller in relation to the ID of the tubing (less than 5%). Maintaining these ratios will reduce the rate that the tubing is being worn from the inside (Figure B).
- 4. Slow down the speed of the drive.** This will cause a more gentle pumping action and increase the life of your tubing. Since many slurries are also viscous, slowing down the drive speed will also increase the efficiency of the pump.

FIGURE A



Fully occluded tubing



Partially occluded tubing

FIGURE B

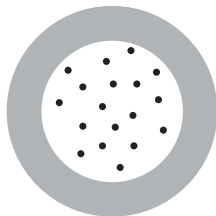

Hard particle size should be 5% of tubing ID

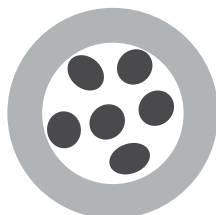

Soft particle size should be 25% of tubing ID

## VISCOUS FLUID BEHAVIOR

Effective viscosity can be better understood by looking at the behavior of viscous fluids at different shear rates. There are a number of types of viscous fluid behavior.

### NEWTONIAN FLUIDS

Viscosity is constant with change in shear rate or agitation. Forces to cause motion increase proportionately as speed increases. Fluids showing Newtonian behavior include water, mineral oils, syrup, hydrocarbons, and resins.

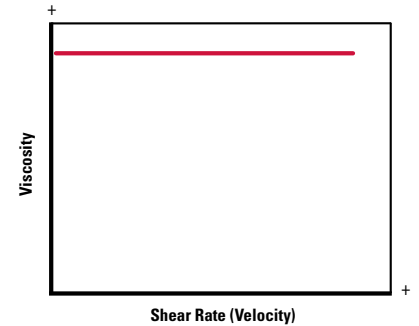

### DILATANT FLUIDS

Viscosity increases as shear rate increases. Forces to cause motion may greatly increase as speed increases. Some liquids showing dilatant behavior are slurries, clay, and candy compounds.

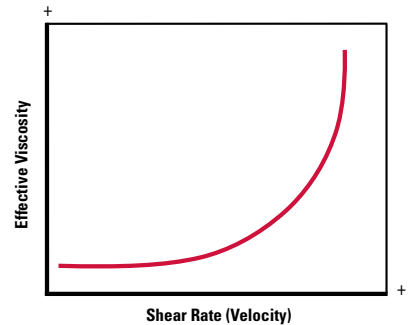

### THIXOTROPIC FLUIDS

Viscosity decreases as shear rate or agitation increases. The forces to cause motion are relatively lower as speed increases. Examples are soaps, tars, vegetable oils, shortening, glue, inks, peanut butter, and some slurries.



### PLASTIC/PSEUDO-PLASTIC FLUIDS

Viscosity decreases as shear rate increases, but initial viscosity may not be great enough to prevent start of flow in a typical pumping system. Typical plastic fluids are gels, latex paints, lotions, and shortening.

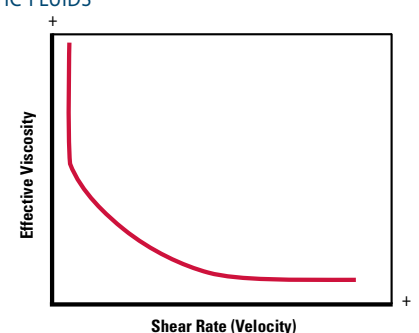





## TUBING SELECTION FOR PUMPING VISCOUS FLUIDS

TO MAXIMIZE THE PUMPING EFFICIENCY OF VISCOUS FLUIDS, FOLLOW THESE STEPS:

1. Slow down the speed of your pump. Increasing the speed beyond a certain point will not have any effect on flow rate. The maximum efficient speed of the pump decreases as viscosity increases and tubing size decreases.
2. Choose a larger size tubing than required to pump water. The table below will help you choose the best size.
3. Choose a firm tubing such as Chem-Durance® Bio, GORE® Style 100SC and Style 500, Norprene®, PharmaPure®, PharMed® BPT, and Tygon® E-LFL. Performance will be better because the tubing returns to its original shape quickly after pump head occlusion. For L/S®, I/P®, and B/T® sizes, choose high-performance precision tubing—the thicker wall also returns more quickly to its original shape than precision tubing. The quicker return allows liquid to be pulled into the tubing with greater force.
4. Select a tubing with a smooth bore. A smooth bore will decrease frictional forces. BioPharm, BioPharm Plus, Tygon® E-Lab, Tygon® E-LFL, or silicone formulations are good choices.
5. Decrease the viscosity of your fluid. Heat your fluid if possible; viscosity usually decreases with temperature.



### TUBING SELECTION GUIDE FOR PUMPING VISCOUS FLUIDS

#### How to use this graph:

Example: You have an 800 centipoise fluid that you wish to pump and you need to determine what the minimum tubing size you need to pump this viscous fluid. Look at the Viscosity axis on the left hand side of the graph and find 800 centipoise. Follow this over until it meets the line. At the intersection of the line and 800 centipoise, follow this down to the Minimum Tube Size axis to see which tubing range it falls within. In this scenario the 800 centipoise falls in the range of the L/S 16 tubing size. Therefore, the minimum tube size needed to pump 800 centipoise is L/S size 16. All viscosities below 800 centipoise can be used with an L/S size 16 tube as well.

Considerations: All viscosity test data was obtained using firm tubing materials such as Norprene®, PharMed® BPT, Viton®, and Tygon® because these formulations perform the best in viscous fluid applications. Tests were performed with fluids at 21°C (70°F) and 0 bar (0 psig) of back pressure. This graph is best used as a general guideline only, and is not a guarantee that you will achieve the results shown.

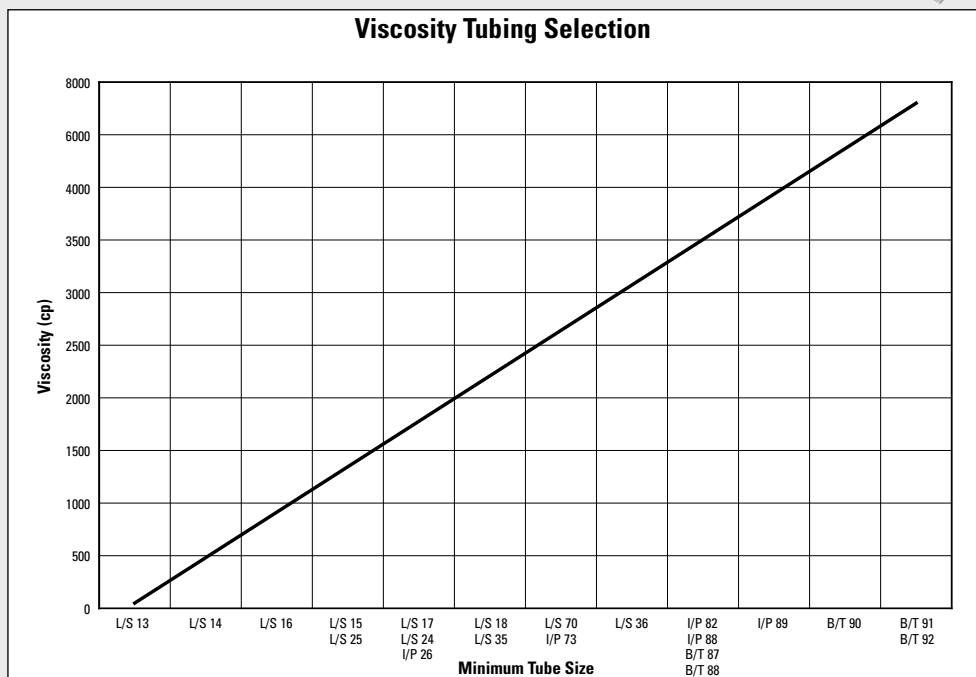

### FREE TECHNICAL APPLICATIONS ASSISTANCE

Our team of **scientific experts** is trained to answer your most **challenging questions** because they are **experienced** in a wide variety of backgrounds, including **biology, chemistry, biochemical engineering, and physics**.



For answers, call our  
**APPLICATION SPECIALISTS**

**CHALLENGE:** An adhesives manufacturer needed to dose different types and different volumes of viscous rapid-drying glue. Pumps with valves and moving parts were prone to getting stuck or would have to be cleaned very thoroughly at the end of a session. In some cases, pumps were damaged beyond recovery.

**OUR SOLUTION:** We recommended L/S® 24 high-performance precision (thicker-walled) platinum-cured silicone tubing. Silicone is the only tubing that can be used more than once. The rapid-drying glue can actually be stored in the silicone tubing for several days if the outlet of the tubing is closed.

The manufacturer now uses an L/S® standard digital drive 07522-20 (see pages 88–89) and Easy-Load® II pump head 77200-62 (see pages 44–45) to dose 20 and 50 mL of rapid-drying glue with a viscosity of approximately 1200 cp. Oversizing the tubing allows the pump to run at speeds under 200 rpm; facilitating pumping of the viscous glue.

## MASTERFLEX® VACUUM/SUCTION LIFT DATA

Masterflex® pumps offer excellent vacuum/suction lift. To achieve maximum lift, choose your tubing size and material carefully. The lower the ID-to-wall ratio, the better the vacuum performance. The stiffer the wall material, the better the vacuum level. In general, Norprene®/PharMed® BPT materials enable you to generate the highest level of vacuum before collapsing, and give you the longest life in a fluidless application; adjustable occlusion pump heads generate the best level of vacuum.

The easy-to-use graph and table below can help you determine the speed required to achieve the vacuum level required. All of the vacuum tests were conducted with either the Standard, High-Performance, or Rapid-Load® pump heads, depending on tubing size. The rated vacuum was generated after running for two minutes.

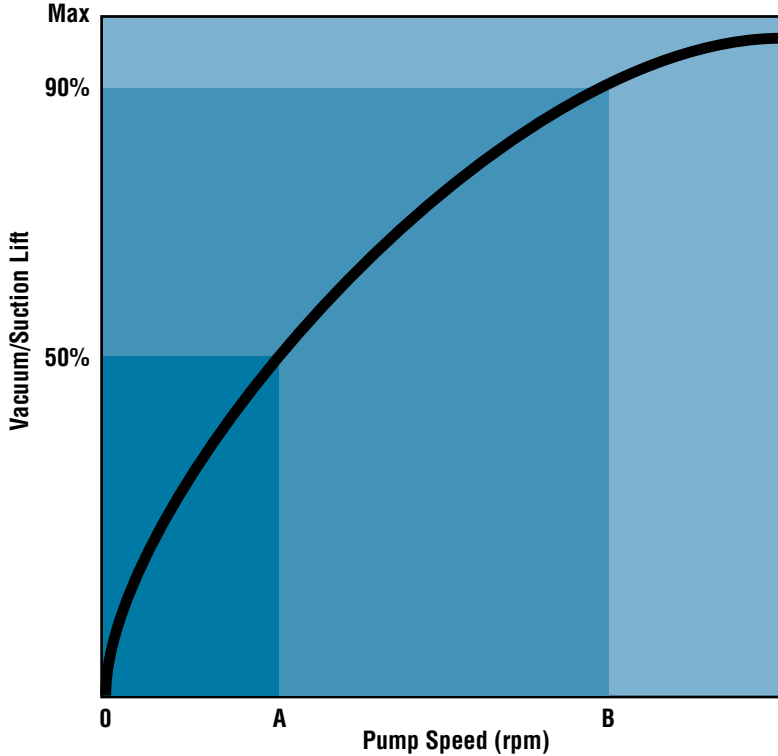

### VACUUM/SUCTION LIFT

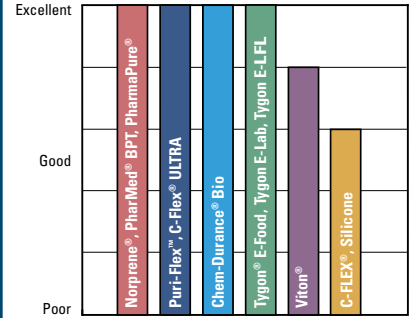

Vacuum/suction lift capability depends greatly on the tubing's ability to maintain its shape. Thus, a firmer tubing type in the smallest possible bore size will generate a stronger vacuum for your application. Higher drive speeds are required to generate the strongest possible vacuum with some tubing sizes.

#### EXAMPLE 1

To generate a 13 in. Hg vacuum (almost 50%) using L/S® 13 silicone tubing, the motor speed must be at least 5 rpm. The pump system will generate the vacuum in about 30 to 60 seconds, depending on the length of the tubing system that needs to be evacuated.

#### EXAMPLE 2

To develop a suction lift of 8.8 m (29 ft) H<sub>2</sub>O with L/S® 15 Norprene® tubing, the motor speed needs to be >50 rpm. At 50 rpm it will take approximately 2 to 3 minutes to prime the pump.

### VACUUM/SUCTION LIFT SPECIFICATIONS

Masterflex® Precision and High-Performance Precision pump tubing																
Tubing size	C-FLEX®/Silicone				Tygon®/Tygon® E-LFL				Norprene®/PharMed® BPT				Viton®			
	Max vac. mm (in.) Hg	Suction m (ft) H <sub>2</sub> O	Pump speed (rpm)		Max vac. mm (in.) Hg	Suction m (ft) H <sub>2</sub> O	Pump speed (rpm)		Max vac. mm (in.) Hg	Suction m (ft) H <sub>2</sub> O	Pump speed (rpm)		Max vac. mm (in.) Hg	Suction m (ft) H <sub>2</sub> O	Pump speed (rpm)	
			A	B			A	B			A	B			A	B
L/S® 13	560 (24)	7.6 (25)	5	50	560 (24)	7.6 (25)	5	20	560 (24)	7.6 (25)	5	20	560 (24)	7.6 (25)	5	50
L/S® 14	560 (24)	7.6 (25)	5	50	560 (24)	7.6 (25)	5	20	560 (24)	7.6 (25)	5	20	560 (24)	7.6 (25)	5	50
L/S® 16	560 (24)	7.6 (25)	5	50	560 (24)	7.6 (25)	5	20	560 (24)	7.6 (25)	5	20	560 (24)	7.6 (25)	5	50
L/S® 25	560 (24)	7.6 (25)	10	50	560 (24)	7.6 (25)	5	50	560 (24)	7.6 (25)	10	50	560 (24)	7.6 (25)	25	50
L/S® 17	313 (12)	4.3 (14)	10	150	313 (12)	4.9 (16)	5	50	403 (16)	5.5 (18)	10	200	403 (16)	5.5 (18)	25	200
L/S® 18	313 (12)	4.3 (14)	10	150	313 (12)	4.9 (16)	10	100	403 (16)	5.5 (18)	10	200	403 (16)	5.5 (18)	25	200
L/S® 15	560 (24)	7.6 (25)	10	75	560 (24)	7.6 (25)	5	50	560 (24)	7.6 (25)	5	50	560 (24)	7.6 (25)	10	100
L/S® 24	560 (24)	7.6 (25)	10	150	560 (24)	7.6 (25)	10	75	560 (24)	7.6 (25)	10	100	560 (24)	7.6 (25)	10	200
L/S® 35	493 (19)	6.7 (22)	50	300	515 (20)	7.3 (24)	50	300	560 (24)	7.6 (25)	50	300	560 (24)	7.6 (25)	50	300
L/S® 36	493 (19)	6.7 (22)	50	300	515 (20)	7.3 (24)	50	300	560 (24)	7.6 (25)	50	500	560 (24)	7.6 (25)	50	300
I/P® 26	560 (24)	7.6 (25)	10	50	560 (24)	7.6 (25)	10	50	560 (24)	7.6 (25)	10	50	515 (20)	7.3 (24)	10	50
I/P® 73	560 (24)	7.6 (25)	25	50	560 (24)	7.6 (25)	10	50	560 (24)	7.6 (25)	10	50	515 (20)	7.3 (24)	25	50
I/P® 82	515 (20)	7.0 (23)	50	200	493 (19)	7.0 (23)	10	50	560 (24)	7.6 (25)	50	200	—	—	—	—
I/P® 70	560 (24)	7.6 (25)	10	50	560 (24)	7.6 (25)	10	50	560 (24)	7.6 (25)	10	50	—	—	—	—
I/P® 88	470 (18)	6.4 (21)	25	50	560 (24)	7.6 (25)	10	50	560 (24)	7.6 (25)	10	50	—	—	—	—
I/P® 89	314 (12)	4.3 (14)	50	200	314 (12)	4.9 (16)	10	50	515 (20)	7.0 (23)	10	50	—	—	—	—
B/T® 87	538 (22)	7.3 (24)	20	40	515 (20)	7.0 (23)	20	40	560 (24)	7.6 (25)	20	40	—	—	—	—
B/T® 91	470 (18)	6.4 (21)	20	40	515 (20)	7.0 (23)	20	40	560 (24)	7.6 (25)	20	40	—	—	—	—

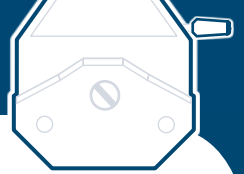

## ELECTRICAL DATA / REGULATORY AGENCIES AND APPROVALS

### RECEPTACLE INFORMATION



### REGULATORY AGENCIES AND APPROVALS

**3-A:** 3-A Sanitary Standards, Inc. (3A SSI) has developed standards and practices for sanitary and hygienic equipment and systems used in the dairy, food processing, and pharmaceutical industries. Products carrying the 3-A designation adhere to standards governing the design, fabrication, installation and operation of equipment and machinery.

**ASCII:** American Standard Code for Information Interchange is a method of encoding characters into 7 or 8 binary bits (typically 7 bits plus an 8th bit for parity).

**ANSI:** The American National Standards Institute is a private organization that coordinates the creation of voluntary standards in a number of fields including engineering, electronics, and construction.

**ASTM:** The American Society for Testing and Materials is a scientific and technical organization that develops material standards and testing methods.

**DIN:** The Deutsche Industrie Normen is a German organization that develops standards from physical quantities engineering to material engineering.

**ISO 9000 series:** The ISO 9000 series of process standards and guidelines address issues concerning product quality. The standards guide manufacturers on the development, production, installation, and inspection of products to ensure consistent quality. Manufacturers must pass a rigorous audit to achieve certification/registration.

**FDA:** Food & Drug Administration is responsible for approving food and drugs for widespread use. Definitions for proper use are found in a series of regulations published annually under Government Regulations CFR 21.

**FM:** FM Global (formerly Factory Mutual) is an international leader in third-party testing, certification, and approval of commercial and industrial products. Product types include electrical, fire protection, fire detection, and hazardous location equipment. FM approval indicates conformance to relevant national and international standards.

**NEMA:** The National Electrical Manufacturers Association is a trade association of electrical equipment manufacturers that develops and publishes many manufacturing standards.

**NIST:** The National Institute of Standards and Technology is a U.S. government agency that provides standard reference materials and calibration services. NIST-certified instruments have been calibrated at NIST or through an official NIST program or collaboration. NIST-traceable instruments have been factory or lab calibrated, by a non-NIST or non-official NIST program/collaboration, where an **unbroken chain of comparisons to stated references** has been established. Non-NIST or non-official NIST programs/collaborations are responsible for establishing the traceability of their own results or values to those of NIST or other stated references.

**NSF:** The National Sanitation Foundation is a nongovernment agency focused on health-related standards for products and services. Certification indicates products suited for applications such as food handling/processing, plumbing, and water distribution.

**NTEP:** National Type Evaluation Program (NTEP) is an evaluation program administered by the National Conference on Weights and Measures (NCWM). Weighing and measuring devices are examined by NTEP to verify that operating characteristics and features comply with the applicable

The icons below represent agencies that give various product approvals. Look for them next to products in this catalog.

Products with this symbol meet ISO quality standards for design, development, and servicing capabilities.



Products with this symbol conform to ATEX Directive 94/9/EC—a European directive applied to equipment intended for use in potentially explosive atmospheres.



Products with this symbol are listed by Underwriters Laboratories, Inc. Samples of these products have been evaluated by UL and meet the applicable UL standards for safety.



Products with this mark meet certain requirements as reported by FM Global.



Products with this symbol bear the UL Listing Mark for Canada.



Products with this symbol have been tested and certified by NSF International. NSF is a nongovernmental agency that focuses on health-related standards for products and services.



Products with this symbol bear the UL Listing Mark for Canada and the U.S.



Products with this symbol have been approved for use with dairy products. It is recognized and used by industries that require sanitary products.



Products with this symbol are recognized under the Recognized Component Program of Underwriters Laboratories, Inc.



Products with this symbol are listed by ETL Testing Laboratories, Inc. and meet applicable safety standards within the U.S. and Canada.



Products with this symbol meet specific standards related to official EPA test protocols.



This symbol assures you that the product meets certain safety standards and/or performance criteria as set by the Canadian Standards Association.



Products with this symbol meet specific standards of the American Water Works Association; applicable to equipment used in the delivery, treatment, and testing of drinking water.



Products with this symbol conform to certain standards and are eligible to be placed on the market in the European Community.



Products with this symbol measure temperatures based on the ITS-90 temperature scale.



Products with this symbol have been certified to Cenelec (European Electrotechnical Standardization) and/or IEC (International Electrotechnical Commission) for use in hazardous areas.



Products with this symbol comply with standards of the National Type Evaluation Program applicable to the performance characteristics of weighing and measuring devices.



requirements of NIST Handbook 44, *Specifications, Tolerances, and Other Technical Requirements for Weighing and Measuring Devices*.

**OEM:** Products used by Original Equipment Manufacturers in the design of equipment.

**OSHA:** The Occupational Safety and Health Administration oversees and regulates workplace health and safety.

**REACH:** a European Community Regulation on chemicals and their safe use (EC 1907/2006). It deals with the Registration, Evaluation, Authorization and Restriction of Chemical substances.

**RoHS:** The Restriction of Hazardous Substances directive aims to restrict certain dangerous substances commonly used in electrical and electronic equipment.

**UL:** Underwriters Laboratories, Inc. is concerned with safety of personnel and property. UL listing indicates compliance with UL safety standards for electrical, mechanical, and fire hazards.

**USP Class VI:** Safety evaluation standards of the U.S. Pharmacopoeia/National Formulary for biocompatibility with plastics.

## ENCLOSURE RATINGS / STANDARD PIPE THREAD FITTINGS

### INGRESS PROTECTION (IP) RATINGS

The IP rating system classifies the degrees of protection from solid objects and liquids afforded by electrical equipment and enclosures. The system is recognized in most countries and is set out in a number of British and European standards.



These include: Classification of Degrees of Protection Provided by Enclosures, BS (British Standards) 5490:1977; IEC (International Electrotechnical Commission) 529:1976.

Specifications for Degrees of Protection of Enclosures of Switchgear and Control Gear for voltages up to and including 1000 VAC and 1200 VDC, BS 5420:1977; and IEC 144:1963.

#### First Digit

##### Protection against solid objects

- 0 no protection
- 1 protected against solid objects over 50 mm (e.g. accidental touch by hands)
- 2 protected against solid objects over 12 mm (e.g. fingers)
- 3 protected against solid objects over 2.5 mm (tools)
- 4 protected against solid objects over 1 mm (fine tools/wires)
- 5 protected against dust—limited ingress (no harmful deposits)
- 6 totally protected against dust

#### Second Digit

##### Protection against liquids

- 0 no protection
- 1 protected against vertically falling drops of water (e.g. condensation)
- 2 protected against direct sprays of water up to 15° from the vertical
- 3 protected against spraying water up to 60° from the vertical
- 4 protected against water sprayed from all directions—limited ingress permitted
- 5 protected against low-pressure jets of water from all directions—limited ingress permitted
- 6 protected against strong jets of water from all directions—limited ingress permitted (e.g. for use on ship decks)
- 7 protected against the effects of immersion between 15 cm and 1 m

### NEMA/IEC ENCLOSURE RATINGS

Conversion of NEMA type classifications to IEC classification designation (IP ratings).

**Note:** NEMA standards meet or exceed IEC standards; therefore, the conversion does not work in the opposite direction.

NEMA enclosure type no.	NEMA definition	IEC enclosure class
1	General-purpose. Protects against dust, light, and indirect splashing but is not dust-tight; primarily prevents contact with live parts; used indoors and under normal atmospheric conditions.	IP10
2	Drip-tight. Similar to Type 1 but with addition of drip shields; used where condensation may be severe (as in cooling rooms and laundries).	IP11
3 and 3S	Weather-resistant. Protects against weather hazards such as rain and sleet; used outdoors on ship docks, in construction work, and in tunnels and subways.	IP54
3R	Intended for outdoor use. Provides a degree of protection against falling rain and ice formation. Meets rod entry, rain, external icing, and rust-resistance design tests.	IP14
4 and 4X	Watertight (weatherproof). Must exclude at least 65 GPM of water from 1-in. nozzle delivered from a distance not less than 10 ft for 5 minutes. Used outdoors on ship docks, in dairies, and in breweries.	IP56
5	Dust-tight. Provided with gaskets or equivalent to exclude dust; used in steel mills and cement plants.	IP52
6 and 6P	Submersible. Design depends on specified conditions of pressure and time; submersible in water; used in quarries, mines, and manholes.	IP67
7	Hazardous. For indoor use in Class I, Groups A, B, C, and D environments as defined in the NEC.	—
8	Hazardous. For indoor and outdoor use in locations classified as Class I, Groups A, B, C, and D as defined in the NEC.	—
9	Hazardous. For indoor and outdoor use in locations classified as Class II, Groups E, F, or G as defined in the NEC.	—
10	MSHA. Meets the requirements of the Mine Safety and Health Administration, 30 CFR Part 18 (1978).	—
11	General-purpose. Protects against the corrosive effects of liquids and gases. Meets drip and corrosion-resistance tests.	—
12 and 12K	General-purpose. Intended for indoor use, provides some protection against dust, falling dirt, and dripping noncorrosive liquids. Meets drip, dust, and rust resistance tests.	IP52
13	General-purpose. Primarily used to provide protection against dust, spraying of water, oil, and noncorrosive coolants. Meets oil exclusion and rust resistance design tests.	IP54

### STANDARD PIPE THREAD FITTINGS

The illustrations are actual size. If you have any question as to the size of fitting you require, simply compare the threads per inch, the diameter and length of the threading, and the taper of the threading of your existing fittings to these drawings.

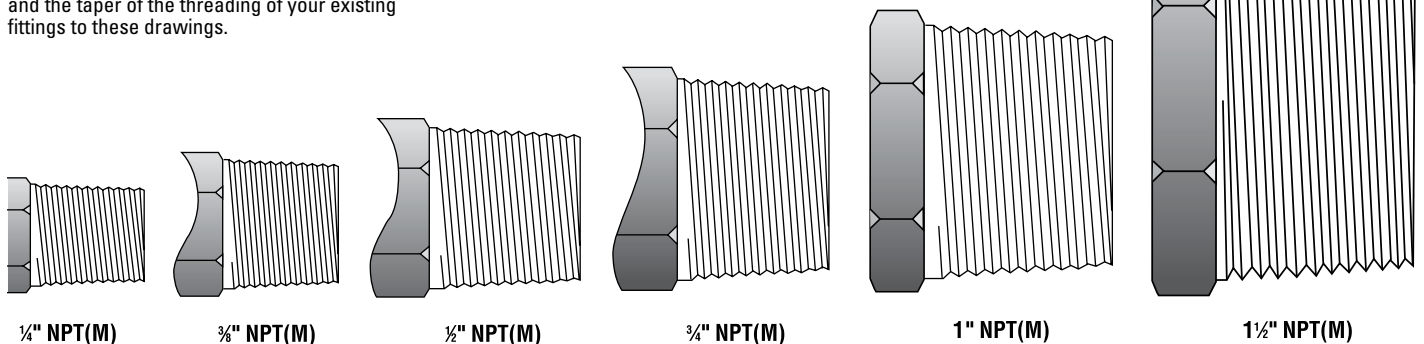
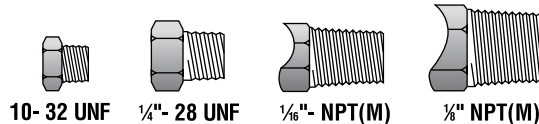

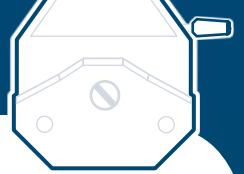

## ELECTRICAL DATA / HAZARDOUS AREA CLASSIFICATIONS

### ATEX DIRECTIVE 94/9/EC

Since 1st July 2003 the ATEX Directive 94/9/EC has required equipment and protective systems that are for use in potentially explosive atmospheres, to conform to specific safety standards. The directive is applicable to all countries within the EU.

#### Equipment Marking

The following is a guide only to the identification markings on ATEX marked equipment and protective systems.

Determining the suitability of ATEX marked equipment and safety systems is the responsibility of the user.

### EU Directive 94/9/EC from July 1, 2003 —Table 1

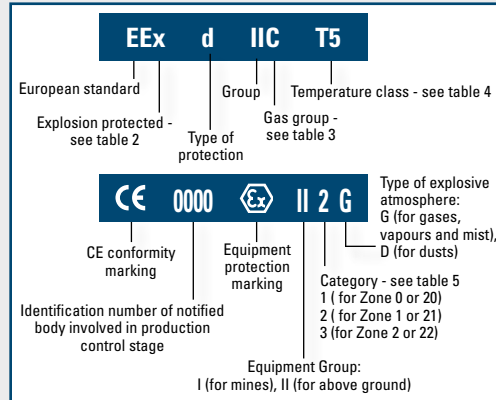

### Methods of Protection—Table 2

Method of protection	Marking	Protection principle
<b>Electrical equipment for gases, vapours and mists according to CENELEC</b>		
Flameproof enclosure	<b>EEx d</b>	Contain the explosion and prevent flame propagation
Increased safety	<b>EEx e</b>	No arcs, sparks, or hot surfaces
Nonsparking	<b>EEx n</b>	No arcs, sparks, or hot surfaces
Intrinsic safety	<b>EEx i</b>	Limit the energy of the spark and surface temperature
Oil immersion	<b>EEx o</b>	Keep the ignition source constantly immersed in oil
Pressurised enclosure	<b>EEx p</b>	A protective gas contains the ignition source
Sand filling	<b>EEx q</b>	Fine ground filling surrounds the ignition source and therefore, an arc from inside of the housing cannot ignite the surrounding combustible atmosphere

### Classification of Gases and Dusts per CENELEC/IEC—Table 3

Gas group	Temperature class					
	T1	T2	T3	T4	T5	T6
I	Methane	—	—	—	—	—
IIA	Acetone Methane Ethane Propane	Ethyl alcohol Cyclohexane <i>n</i> -butane <i>n</i> -butyl alcohol	Diesel fuel Aircraft fuel Fuel oil <i>n</i> -hexane Heptane	Acetaldehyde	—	—
IIB	Coal (lighting) gas Acrylonitrile	Ethylene Ethylene oxide	Ethylene glycol Hydrogen sulphide	Ethyl methyl ether	—	—
IIC	Hydrogen	Ethine (Acetylene)	—	—	—	Carbon disulphide

### Temperature Classification—Table 4

CENELEC/IEC (Group II) Class	Max surface temperature	Comments
T1	450°C (842°F)	Temperature relates to all parts of equipment that can come into contact with the potentially explosive atmosphere
T2	300°C (572°F)	
T3	200°C (392°F)	
T4	135°C (275°F)	
T5	100°C (212°F)	
T6	85°C (185°F)	Assessment of equipment temperature class is the responsibility of the user
Tx	Maximum surface temperature not defined	

#### Example equipment marking:

**CE Ex II 2 G EEx d IIC T5**

ATEX Category 2 (gas) equipment designated for installation in Zone 1. Protection by flameproof enclosure, suitable for hydrogen atmosphere with maximum equipment surface temperature of 100°C.

### Equipment Groups I and II: Categories M1, M2, 1, 2, and 3—Table 5

Group I Mines: methane and/or combustible dusts		Group II Above ground: potentially explosive atmospheres or gas/air or dust/air mixtures, mist or vapours					
Category M		Category 1		Category 2		Category 3	
1	2	G (Gas) (Zone 0)	D (Dust) (Zone 20)	G (Gas) (Zone 1)	D (Dust) (Zone 21)	G (Gas) (Zone 2)	D (Dust) (Zone 22)
Equipment which guarantees a very high degree of safety. Operation guaranteed in case of errors.	Equipment which guarantees a very high degree of safety. Switching off possible if potentially explosive atmosphere occurs.	For equipment which guarantees a very high degree of safety. Intended for cases where potentially explosive atmospheres are often or constantly to be expected.		For equipment which guarantees a high degree of safety. Intended for cases where a potentially explosive atmosphere is to be expected.		For equipment which guarantees a standard degree of safety. Intended for cases where a potentially explosive atmosphere can be expected only rarely, and then, only for a short time.	
Very high protection level	High protection level	Very high protection level		High protection level		Normal	

### National Electrical Code (NEC) Hazardous Area Classifications

- CLASS I:** Areas where flammable gases or vapors may be present in the air in sufficient quantities to be explosive
- Group A:** Atmospheres containing acetylene
- Group B:** Atmospheres such as butadiene, ethylene oxide, propylene oxide, acrolein, or hydrogen (or gases or vapors equivalent in hazard to hydrogen, such as manufactured gas)
- Group C:** Atmospheres such as cyclopropane, ethyl ether, or ethylene (or gas or vapors of equivalent hazard)
- Group D:** Atmospheres such as acetone, alcohol, ammonia, benzene, benzol, butane, gasoline, hexane, lacquer solvent vapors, naphtha, natural gas, propane, or gas or vapors of equivalent hazard
- CLASS II:** Areas made hazardous by the presence of combustible dust
- Group E:** Atmospheres containing combustible
- metal dusts, regardless of resistivity
  - dust of similarly hazardous characteristics having a resistivity less than 100 kΩ-cm
  - electrically conductive dusts
- Group F:** Atmospheres containing combustible
- carbon black, charcoal, or coke dusts having more than 8% total volatile material
  - dusts so sensitized that they present an explosion hazard, and dusts having a resistivity greater than 100 Ω-cm but less than or equal to  $1 \times 10^8 \Omega\text{-cm}$
- Group G:** Atmospheres containing combustible
- dust having resistivity equal to or greater than 100 kΩ-cm
  - electrically nonconductive dusts
- CLASS III:** Areas made hazardous by the presence of easily ignitable fibers or dust, but which are not likely to be suspended in the air in sufficient quantities to ignite
- Division 1:** Atmospheres where hazardous concentrations exist continuously, intermittently, or periodically under normal operating conditions
- Division 2:** Atmospheres where hazardous concentrations exist only in case of accidental rupture or breakdown of equipment
- EXPLOSION-PROOF:** Enclosures or housings are designed to withstand internal explosions and prevent the spread of fire to the outside.
- INTRINSICALLY SAFE:** Systems in which electrical energy in the circuits is not present at levels that would ignite a flammable mixture of a gas and air.

## GLOSSARY

**Accuracy:** The degree of precision. Usually expressed, in terms of error, as a percentage of the specified value, or as a percentage of a range.

**A/D:** Analog-to-digital conversion. The process changes an analog signal into a digital value representative of the magnitude of the signal at the moment of conversion.

**Absolute pressure (psia):** The total force per unit area exerted by a fluid. It is the sum of atmospheric and gauge pressures.

**Alternating current (AC):** Current that reverses polarity at a uniform frequency.

**Atmospheric pressure:** The force exerted per unit area by the weight of the atmosphere.

**Automatic temperature compensation (ATC):** meters with ATC receive a continuous signal from a temperature sensor in a solution and then automatically standardize the displayed value to 25°C.

**Baud rate:** A unit of measure for data transmission speed. It represents the number of signal elements (typically bits) transmitted per second. Typical baud rates are 600, 1200, 2400, 4800, 9600, 19.2K, 35.4K, and 115.2K.

**Buffer:** In chemistry terms, a solution that maintains a set pH value regardless of added acids or bases; often used for calibration. In computer terms, a device used to store data temporarily, normally to compensate for differences in speed between system components (for example, a high-speed data acquisition board and main memory).

**Byte:** Eight related bits of information processed as a unit. Eight bits equal one byte.

**Cavitation:** Process in which small bubbles are formed and implode violently. This results in aggressive cleaning action in ultrasonic cleaners.

**Contacts:** Elements used to mechanically make or break an electric circuit.

**Continuous duty:** A device able to operate continuously with no off or rest periods.

**Convection:** Transmission of energy or mass in a medium by movement of the medium itself.

**Density:** The mass of a given substance per unit volume, often expressed as pounds/ft<sup>3</sup> or grams/cm<sup>3</sup>.

**Direct current (DC):** A current with a constant polarity.

**Double-pole, double-throw (DPDT):** A term used to describe a switch or relay output contact form (form C). Two separate switches that operate simultaneously, each with a normally open and normally closed contact and a common connection.

**Explosion-proof (XPRF) motor:** A totally enclosed motor that will withstand an explosion of a specific vapor or gas within its housing, or will prevent sparks or flashes generated within its housing from igniting surrounding vapor or gas.

**Factory calibration:** The tuning or altering of a control device by the manufacturer to bring it into specification.

**Gain:** Ratio of output voltage, current, or power to input voltage, current, or power.

**Gauge pressure (psig):** A measure of the force per area exerted by a fluid using atmospheric pressure as a zero reference.

**Impedance:** The opposition in an electric circuit to the flow of an alternating current. It consists of ohmic resistance, inductive reactance, and capacitive reactance.

**Inductive load:** Electrical devices made of wound or coiled wire. Current passing through the coil creates a magnetic field that in turn produces mechanical work.

**Intrinsically safe motor:** A motor designed to prevent sparks generated within its housing from igniting surrounding vapor or gas, but is not rated "explosion-proof."

**Ion-selective electrode (ISE):** An electrode that is sensitive to specific ions in a solution.

**LIMS (Laboratory Information Management System):** A system that manages operations of a testing laboratory.

**Linearity:** The degree to which performance or response approaches the condition of being linear. Expressed in percent.

**Normally closed (NC):** A switch in which the contacts are closed (contacting) without any external force acting upon it.

**Normally open (NO):** A switch in which the contacts are open (separated) when no external forces act upon the switch.

**On/off control:** A simple control system in which the device being controlled is either full on or full off, with no intermediate operating positions.

**Open drip-proof (ODP) motor:** An open motor with ventilator openings that prevent liquids and solids, dropped from an angle of 0° to 15° from vertical, from interfering with its operation.

**Parallel transmission:** The transmission of data bits over different lines, usually simultaneously; as opposed to serial transmission.

**pH:** An indication of the acidity or alkalinity of a solution. Units range from 0 (most acidic), to 7 (neutral), to 14 (most alkaline).

**PID control (proportional, integral, derivative):** Control in which the control signal is a linear combination of the error signal, its integral, and its derivative.

**Pressure:** Force exerted per unit area.

**Proportional control:** Control in which the amount of corrective action is proportional to the amount of error.

**Range:** The limits within which a device or circuit operates or the distance over which a transmitter operates reliably.

**RS-232:** A standard computer interface used primarily to connect PCs and microprocessors with instruments, such as pH meters.

**Serial transmission:** Sending one bit at a time on a single transmission line.

**Series (Universal) motor:** A non-induction type motor utilized for small equipment. Speed will decrease as load increases.

**Shaded-pole motor:** A low-starting torque motor that depends on induced current to create the magnetic field necessary to start the motor.

**Shunt:** A conductor joining two points in an electrical circuit to form a parallel path. All or some portion of the current may pass through the shunt.

**Single-phase motor:** Any motor energized by a single alternation voltage.

**Single-pole, double-throw (SPDT):** A switch that in one position completes one of two circuits. In the second position the switch completes a second circuit and breaks the first circuit.

**Single-pole, single-throw (SPST):** A switch that will open or complete a circuit.

**Solid-state:** Any element that controls current without moving parts, heated filaments, or vacuum gaps.

**Standard operating conditions, standard temperature and pressure (STP):** Defined temperature and pressure to which all values are referenced for comparison. Generally 760 mm Hg (1 atm), 25°C.

**Stop bit:** A signal following a character or block that prepares the receiving device to receive the next character or block.

**Temperature compensation:** Correction for the influence of temperature on a measurement.

**Tolerance:** The maximum allowable deviation from a specified standard, as the range of variation permitted, expressed in actual values or more often as a percentage of the nominal value.

**Totally enclosed (TE) motor:** Motors that prevent the free flow of air from the inside of the motor enclosure to the outside.

**Totally enclosed, nonventilated (TENV) motor:** A motor in a totally enclosed housing that is not equipped with an external cooling device.

**Totally enclosed, fan-cooled (TEFC) motor:** A motor in a totally enclosed housing that is equipped with a separate external blower.

**Transducer:** Any device that generates an electrical signal from real-world physical measurements.

**Transmitter:** A device that translates the low-level output of a sensor or transducer to a higher level signal suitable for transmission to a site where it can be further processed.

**Three-phase motor:** A relatively inexpensive, self-starting motor (no starting winding or capacitor); can start heavy loads. The motor requires a three-phase AC power supply.

**Universal Serial Bus (USB):** A serial bus standard to connect devices to a host computer. Conveniences include plug-and-play and low-power transmission.

**Viscosity:** The resistance of a fluid to flow when subjected to shear stress.

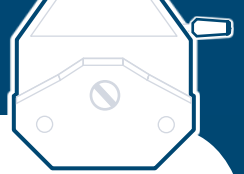

## CONVERSION FACTORS

To go from	Multiply by	To get
atm	33.89854	ft H <sub>2</sub> O
atm	760	mm Hg
atm	1.033227	kg/cm <sup>2</sup>
atm	14.705	psi
atm	1.01325	bar
atm	101.325	kPa
atm	101325	Pa
bar	14.50377	psi
bar	0.9869233	atm
bar	100,000	Pa
BTU	778.196	lb-ft
BTU/min	0.01757	kW
BTU/hr	0.216158	lb-ft/sec
BTU/min	0.023575	hp
cm	0.3937008	inch
cm	0.03280840	feet
cm <sup>3</sup>	0.03381402	oz (fluid)
cm <sup>3</sup>	0.001	liter
cc/min	1	mL/min
cc/min	0.016	GPH
deg C	(1.8 x °C) + 32	deg F
deg C	deg °C + 273.2	K
deg F	0.555 (°F - 32)	deg C
K	K - 273.2	deg C
dyne	0.00102	gm
dyne	0.000002248	lb (force)
dyne	0.00003597	oz
dyne-cm	0.00102	gm-cm
dyne-cm	0.00000007376	lb-ft
dyne-cm	0.000014	oz-in
dyne/cm <sup>2</sup>	0.1	Pa
feet (ft)	30.48	cm
ft	0.3048	m
ft H <sub>2</sub> O	0.4335	psi
ft H <sub>2</sub> O	0.0295	atm
ft H <sub>2</sub> O	0.8826	in Hg
ft <sup>3</sup>	7.480519	gal
ft <sup>3</sup>	0.028316847	m <sup>3</sup>
ft <sup>3</sup> /hr	0.4719474	LPM
ft <sup>3</sup> /hr	471.9474	mL/min
ft <sup>3</sup> /min	0.0283157	m <sup>3</sup> /min
ft <sup>3</sup> /min	28.3157	LPM
gallon (gal)	128	oz (fluid)
gal	3.785412	liter
gal	8.337	lb H <sub>2</sub> O
gal	0.1337	ft <sup>3</sup>
gal	230.9	in <sup>3</sup>
gal	0.003785	m <sup>3</sup>
gal (IMP)	1.20095	gal (US)
gal (US)	0.83267	gal (IMP)
GPH	63.1	mL/min
GPM	3.785412	LPM
GPM	0.2271247	m <sup>3</sup> /hr

To go from	Multiply by	To get
gram (gm)	0.002205	lb
gm	0.03527	oz (avd)
gm (force)	980.7	dyne
gm-cm	980.7	dyne-cm
gm-cm	0.0000723	lb-ft
gm-cm	0.01389	oz-in
gm-cm	0.000867	lb-in
gm-cm	0.000098	N-m
gm-cm <sup>2</sup>	0.22757	oz-in <sup>2</sup>
horsepower (hp)	0.7457	kW
hp	42.44	BTU/min
hp	1.01387	hp (metric)
hp	396,000	lb-in/min
hp (metric)	0.9862	hp
inch (in)	2.54	cm
in	25.40	mm
in <sup>3</sup>	0.004329	gal
in <sup>3</sup>	0.01639	liter
in <sup>3</sup>	16.39	mL
in Hg	1.1329	ft H <sub>2</sub> O
in Hg	0.4926	psi
in Hg	25.64	mm Hg
in Hg	3386	Pa
joule	0.0009478	BTU
joule	0.73756	lb-ft
kg	2.2046	lb
kg-cm	13.89	oz-in
kg-m	7.246	lb-ft
kg/cm <sup>2</sup>	14.22334	psi
kg/cm <sup>2</sup>	0.9678	atm
kW	56.92	BTU/min
kW	1.341	hp
kPa	0.009867841	atm
kPa	0.14504	psi
lb (pound)	444822	dyne
lb	453.597	gm
lb	0.453597	kg
lb	16	oz
lb (force)	4.44822	N
lbs H <sub>2</sub> O	0.1199	gal
lb-in	1152.5	gm-cm
lb-in	0.1129	N-m
lb-in/min	0.000002525	hp
lb-ft	0.001285	BTU
lb-ft	13,560,000	dyne-cm
lb-ft	1.3558	N-m
lb-ft	192	oz-in
lb-ft	0.1383	kg-m
lb-ft	13825	gm-cm
lb-ft/sec	1.355	watt
lb-ft/sec	4.625	BTU/hr
lb-ft/min	0.022589	watt
liter (L)	1000	cm <sup>3</sup>
liter	0.2642	gal
liter	0.001	m <sup>3</sup>
liter	61.0237	in <sup>3</sup>
LPM	0.2642	GPM
LPM	2.11888	ft <sup>3</sup> /hr
LPM	0.035316	ft <sup>2</sup> /min

To go from	Multiply by	To get
mL	0.061	in <sup>3</sup>
mL	0.033818	oz (fluid)
mL/min	0.0158	GPH
mL/min	0.0333818	oz/min
mL/min	1	cc/min
mL/min	0.00211	ft <sup>3</sup> /hr
mm	0.03937	in
mm Hg	0.03937	in Hg
mm Hg	0.001315	atm
mm Hg	133.3	Pa
meter (m)	3.2808	feet
m <sup>3</sup>	1000	liter
m <sup>3</sup>	35.316	ft <sup>3</sup>
m <sup>3</sup>	264.2	gal
m <sup>3</sup> /min	35.316	ft <sup>3</sup> /min
m <sup>2</sup> /hr	4.405	GPM
Newton (N)	0.2248	lb (force)
N-m	141.612	oz-in
N-m	10197.16	gm-cm
N-m	0.737562	lb-ft
N-m	8.850	lb-in
Newton/m <sup>2</sup>	1	Pa
ounce (oz)	28.3495	gm
oz	0.0625	lb
oz (force)	27801.39	dyne
oz	0.001943	slug
oz (fluid)	29.57	mL
oz (fluid)	0.007813	gal
oz (fluid)	29.57	gal cm <sup>3</sup>
oz-in	0.072	kg-cm
oz-in	72.007	gm-cm
oz-in	70620	dyne-cm
oz-in	0.00521	lb-ft
oz-in	0.007061	N-m
oz-in <sup>2</sup>	4.3941	gm-cm <sup>2</sup>
oz/min	29.57	mL/min
Pascal (Pa)	10	dyne/cm <sup>2</sup>
Pa	1	Newton/m <sup>2</sup>
Pa	0.0000099	atm
Pa	0.00001	bar
Pa	0.0002953	in Hg
Pa	0.000145	psi
Pa	0.0075	mm Hg
psi	6.895	kPa
psi	0.068046	atm
psi	0.0689	bar
psi	2.30666	ft H <sub>2</sub> O
psi	2.036	in Hg
psi	0.070307	kg/cm <sup>2</sup>
psi	6894.76	Pa
slug	514.785	oz
watt (W)	0.737562	lb-ft/sec
W	44.2537	lb-ft/min

### MORE online!

For additional technical data including more conversions, viscosity values, wire gauge sizes, conductivity values, electrical diagrams, and more.

[Masterflex.com/TechInfo](http://Masterflex.com/TechInfo)





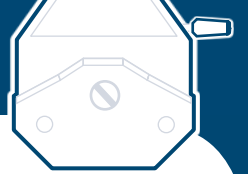

## CHEMICAL RESISTANCE CHARTS

### WARNING

The information in this chart has been supplied to Cole-Parmer by other reputable sources and is to be used **ONLY** as a guide in selecting equipment for appropriate chemical compatibility. Before permanent installation, test the equipment with the chemicals under the specific conditions of your application. Ratings of chemical behavior listed in this chart apply to a 48-hour exposure period; Cole-Parmer has no knowledge of possible effects beyond this period. Cole-Parmer does not warrant (neither expressed nor implied) that the information in this chart is accurate or complete or that any material is suitable for any purpose.

### ⚠ DANGER

Variations in chemical behavior due to factors such as temperature, pressure, and concentration can cause equipment to fail, even though it passed an initial test.

#### SERIOUS INJURY MAY RESULT.

Use suitable guards and/or personal protection when handling chemicals.

### RATINGS

#### Chemical Behavior

- A** – No effect
- B** – Minor effect
- C** – Moderate effect
- D** – Severe effect; not recommended
- No data available

CHEMICAL	Plastics											Elastomers										Metals					Nonmetals												
	ABS plastic	Acetal	CPVC	Epoxy	Hyrel®	HDPE	LDPE	Noryl®	Nylon	Polycarbonate	Polypropylene	PPS	PTFE	PVC	PVDF	Nitrile (Buna N)	EPDM	Hypalon®	Kel-F®	Natural rubber	Neoprene	Santoprene®	Silicone	Tygon®	Viton®	304 stainless steel	316 stainless steel	Aluminum	Brass	Bronze	Carpenter 20	Cast iron	Copper	Hastelloy C®	Titanium	Carbon graphite	Ceramic Al <sub>2</sub> O <sub>3</sub>	Ceramic magnet	
Arsenic Acid	A2	D	A1	A2	B1	B	B2	A1	C1	A1	A	A	A1	A	A2	A2	A	A	B	A	B	A	B	A2	A2	A2	D	D	B	A1	D	A	B	B	A	A	A	A	
Arsenic Salts	—	—	—	—	—	—	—	—	—	—	—	—	—	—	—	—	—	—	—	—	—	—	—	—	—	—	—	—	—	—	—	—	—	—	—	—	—	—	
Asphalt	—	B2	A2	A	A	—	A1	—	A	D	B1	A	A1	A2	A	B	D	D	A	D	D	—	—	—	—	—	—	—	—	—	—	—	—	—	—	—	—	—	—
Barium Carbonate	A2	A	A2	A2	—	—	B2	A2	A	A	A2	A	A	A	A	A	A	A	—	—	—	—	—	—	—	—	—	—	—	—	—	—	—	—	—	—	—	—	
Barium Chloride	A2	A	A1	A2	B1	B	A1	A	A	A	A	A	A	A	A	A	A	—	—	—	—	—	—	—	—	—	—	—	—	—	—	—	—	—	—	—	—	—	
Barium Cyanide	—	B	D	A	—	—	B	—	A1	—	D	—	A	—	C	A	—	—	C	—	—	—	—	—	—	—	—	—	—	—	—	—	—	—	—	—	—		
Barium Hydroxide	A2	D	A2	A1	—	—	B2	A2	A1	D	B	A	A	A	A	A	—	—	A	—	—	—	—	—	—	—	—	—	—	—	—	—	—	—	—	—	—	—	
Barium Nitrate	—	B2	A	A1	—	—	B2	A1	A1	D	D	A	A1	A	A2	A	—	—	A	—	—	—	—	—	—	—	—	—	—	—	—	—	—	—	—	—	—	—	
Barium Sulfate	A2	B2	B1	A2	D	B	B2	A1	A1	D	B1	A	A	A	A	A	—	—	A	—	—	—	—	—	—	—	—	—	—	—	—	—	—	—	—	—	—	—	
Barium Sulfide	A2	A	A2	B2	—	—	B2	A2	A1	—	B	—	A	A	A	A	—	—	A	—	—	—	—	—	—	—	—	—	—	—	—	—	—	—	—	—	—	—	
Beer	A2	A1	A2	A2	A1	—	A2	A1	A1	A2	A	A2	A	A	A	A	A	A	A	A	—	—	—	—	—	—	—	—	—	—	—	—	—	—	—	—	—	—	
Beet Sugar Liquids	B	B	A2	A1	—	—	A1	A1	A	A1	A1	A	A1	A2	A	A	A	A	A	A	—	—	—	—	—	—	—	—	—	—	—	—	—	—	—	—	—	—	
Benzaldehyde	B	D	D	D	—	—	B	A1	D	D	D	A	A1	D	D	D	D	D	D	D	—	—	—	—	—	—	—	—	—	—	—	—	—	—	—	—	—	—	
Benzene	B	A1	D	C1	C	B	D	A	A1	D	D	A	A	A	A	A	—	—	A	—	—	—	—	—	—	—	—	—	—	—	—	—	—	—	—	—	—		
Benzene Sulfonic Acid	—	—	—	—	—	—	—	—	—	—	—	—	—	—	—	—	—	—	—	—	—	—	—	—	—	—	—	—	—	—	—	—	—	—	—	—	—	—	
Benzoic Acid	—	B	A1	A1	D	A	A1	B	D	B1	B1	A2	A	A	D	D	D	D	B	—	—	B	D	A	B	B	B	—	B	B	D	—	B1	A	A	A	A		
Benzol	D	A	—	A1	C	—	C1	B	D	D	B	A	A	A	D	D	D	D	A	D	D	D	C1	A	A1	A1	B1	—	A	A	A	—	—	—	—	—	—		
Benzonitrile	—	—	—	—	—	—	—	—	A1	—	—	A2	—	—	—	—	—	—	A2	—	—	—	—	—	—	—	—	—	—	—	—	—	—	—	—	—	—		
Benzyl Chloride	D	A	—	—	—	—	—	D	A2	—	C1	—	—	—	D	D	D	—	—	—	—	—	—	—	—	—	—	—	—	—	—	—	—	—	—	—	—		
Bleach	B	D	A	D	—	—	A	A	D	D	A	A	A	A	A	D	B	D	D	D	—	—	B	—	A	A	—	—	—	—	—	—	—	—	—	—	—	—	
Bleaching Liquors	—	—	—	D	—	—	A1	—	C	—	A1	—	A	A1	—	D	A	—	D	—	—	—	—	—	—	—	—	—	—	—	—	—	—	—	—	—	—		
Borax (Sodium Borate)	—	B	A	A1	A1	A	A2	A1	A	—	B	A	A	A1	A	B	A	A	A	A	—	—	B	—	A	A	B1	—	B	A	A	B	A	B	B	A	A	—	
Boric Acid	—	A	A	A1	A1	A	A2	A1	B	—	A	A	A	A2	A	A	A	A	A	D	A	A	A	A	A	B2	A	A	B	B2	A	D	B	A	B	A	A	—	
Brewery Slop	—	B	D	D	—	—	—	—	—	—	—	—	—	—	—	—	—	—	—	—	—	—	—	—	—	—	—	—	—	—	—	—	—	—	—	—	—		
Bromine	D	D	D	D	D	D	A1	D	C1	D	C1	A	A	A	A	D	D	D	A	D	—	—	D	D	D	D	D	—	D	D	—	—	—	—	—	—	—	—	
Butadiene	—	A	A1	D	—	D	D	D	C1	D	C	A1	A2	C1	A	D	C	B	A	D	B	—	D	A	B	A	A1	—	C	A	—	C	C	—	—	—	—		
Butane	B	A	C1	A1	—	—	C1	D	D	A2	D	A	A	C1	A	A	D	B	A	D	A	—	D	A	A	A2	A2	—	C	A	—	C	A	—	—	—	—		
Butanol (Butyl Alcohol)	—	A	A	A	B1	—	B2	A	B1	B1	A	A	A2	C1	A	A	A	A1	A	A	B	—	D	D	A	A	B	—	C	A	—	C	B	—	—	—			
Butter	B	A	—	—	—	—	—	—	—	—	—	—	—	—	—	—	—	—	—	—	—	—	—	—	—	—	—	—	—	—	—	—	—	—	—	—	—		
Buttermilk	B	A	A1	A1	—	—	A1	A	B1	A1	A1	—	—	—	A	A1	—	—	A	D	D	—	A	B	A	A	A	—	D	—	—	—	—	—	—	—	—		
Butyl Amine	—	C1	—	B2	—	—	C1	D	A2	D	B1	D	A2	D	A1	—	—	D	D	D	—	B1	D	D	—	A	A2	—	B	—	—	—	—	B2	B2	A2	—		
Butyl Ether	—	D	—	—	—	—	—	D	A2	D	D	A2	A1	A2	—	B2	D	—	A1	D	D	—	D	A2	—	A1	B2	—	—	—	—	—	—	—	—	—	—		
Butyl Phthalate	—	—	D	B2	—	—	A	C1	A2	D	B2	A	A2	—	B1	D	B2	D	A1	D	D	—	D	C1	B1	B2	—	—	—	—	—	—	—	B2	B	A	—		
Butylacetate	—	A	C1	B1	B	B	C1	B	A	D	B1	A	A	D	B2	D	B	D	A1	D	D	—	D	D	B	A	A	—	A	B1	A	A	—	—	—	—	—		
Butylene	—	A	A	A1	—	—	B1	—	B1	—	—	—	—	—	—	—	—	—	—	—	—	—	—	—	—	—	—	—	—	—	—	—	—	—	—	—	—		
Butyric Acid	D	A	D	A	B1	D	D	D	C1	D	B1	A	A2	B1	A	D	B	D	A	D	D	A	D	D	B1	B2	B2	B	—	D	B	D	C	A1	A	A	—		
Calcium Bisulfate	—	—	—	—	—	—	—	—	—	—	—	—	—	—	—	—	—	—	—	—	—	—	—	—	—	—	—	—	—	—	—	—	—	—	—	—	—		
Calcium Bisulfide	—	D	A1	A	B1	—	B1	A	—	—	A	—	A2	A	A	A1	C	—	A	D	A	—	C	—	A	B	C	—	C	B	—	—	—	—	—	—	—		
Calcium Bisulfite	—	D	A1	A1	B	A	A1	A1	A2	D	A	A	A	B	A	A	D	A	A	D	A	—	A	—	A	B	A	D	—	B1	—	—	—	—	—	—	—		
Calcium Bromide 38%	—	—	—	—	—	—	—	—	—	—	—	—	—	—	—	—	—	—	—	—	—	—	—	—	—	—	—	B	B	—	—	—	—	—	—	—	—		
Calcium Carbonate	—	A	A1	—	—	—	B1	A2	—	A	C2	A	—	A	A2	A	A	A	—	A	—	—	—	—	—	A1	B	D	—	A	B1	—	—	—	—	—	—		
Calcium Chlorate	—	A	A1	—	—	—	—	—	—	—	—	—	—	—	—	—	—	—	—	—	—	—	—	—	—	—	—	—	—	—	—	—	—	—	—	—	—		
Calcium Chloride (30% in water)	B	D	A2	A1	A1	A	B2	A	A1	—	A2	A	A	A	C	A	A	A	A	A	—	—	—	—	—	C2	B2	D	—	A	B	C	A	B	A	A	A		
Calcium Chloride (saturated)	A	D	A	A4	—	—	—	—	—	—	—	—	—	—	—	—	—	—	—	—	—	—	—	—	—	B	B	B	—	—	—	—	—	—	—	—	—		
Calcium Fluoride	—	—	—	—	—	—	—	—	—	—	—	—	—	—	—	—	—	—	—	—	—	—	—	—	—	—	—	—	—	—	—	—	—	—	—	—	—		
Calcium Hydroxide 10%	—	A	A	A	—	—	—	—	—	—	—	—	—	—	—	—	—	—	—	—	—	—	—	—	—	B	B	C1	—	—	—	—	—	—	—	—	—		
Calcium Hydroxide (saturated)	A	—	A	A	—	—	—	—	—	—	—	—	—	—	—	—	—	—	—	—	—	—	—	—	—	B	B	D	B	C	—	—	—	—	—	—	—		
Calcium Hydroxide	A	D	A2	A1	B1	A	A2	A2	A2	D	A2	A	A	A	B	A2	A	A	A	—	—	—	—	—	—	A	B1	B	C1	—	—	—	—	—	—	—	—		
Calcium Hypochlorite 30%	—	—	A	A	—	—	—	—	—	—	—	—	—	—	—	—	—	—	—	—	—	—	—	—	—	—	—	—	—	—	—	—	—	—	—	—	—		
Calcium Hypochlorite (saturated)																																							











## CHEMICAL RESISTANCE CHARTS



**COLE-PARMER'S CHEMICAL COMPATIBILITY DATABASE APP**

Chemical compatibility ratings where and when you need it—FREE!

Go to [ColeParmer.com/chemchart](http://ColeParmer.com/chemchart) to download iPhone App. Scan the QR code at right with your mobile device to get to our chemical compatibility database.



### WARNING

The information in this chart has been supplied to Cole-Parmer by other reputable sources and is to be used **ONLY** as a guide in selecting equipment for appropriate chemical compatibility. Before permanent installation, test the equipment with the chemicals under the specific conditions of your application. Ratings of chemical behavior listed in this chart apply to a 48-hour exposure period; Cole-Parmer has no knowledge of possible effects beyond this period. Cole-Parmer does not warrant (neither expressed nor implied) that the information in this chart is accurate or complete or that any material is suitable for any purpose.

### DANGER

Variations in chemical behavior due to factors such as temperature, pressure, and concentration can cause equipment to fail, even though it passed an initial test.

#### SERIOUS INJURY MAY RESULT.

Use suitable guards and/or personal protection when handling chemicals.

### RATINGS

#### Chemical Behavior

- A** – No effect
- B** – Minor effect
- C** – Moderate effect
- D** – Severe effect; not recommended
- No data available

CHEMICAL	Plastics												Elastomers										Metals					Nonmetals														
	ABS plastic	Acetal	CPVC	Epoxy	Hytre®	HDPE	LDPE	Noryl®	Nylon	Polycarbonate	Polypropylene	PPS	PTFE	PVC	PVDF	Nitrile (Buna N)	EPDM	Hypalon®	Kal-®	Natural rubber	Neoprene	Santoprene®	Silicone	Tygon®	Viton®	304 stainless steel	316 stainless steel	Aluminum	Brass	Bronze	Carpenter 20	Cast iron	Copper	Hastelloy C®	Titanium	Carbon graphite	Ceramic Al <sub>2</sub> O <sub>3</sub>	Ceramic magnet				
Phosphorus Trichloride	D	D	D	A1	—	A	B	—	A	A2	A	A	D	A2	D	A1	D	A2	D	D	D	—	C	A1	A1	A2	D	—	—	—	—	—	D	D	A2	A	A	A	A	—	—	
Photographic Developer	B	D	A	A	—	A	A	—	A	A2	A	A	D	A2	D	A1	B	B	—	D	D	—	B	A1	A1	A2	D	—	—	—	—	—	D	D	B2	A	A	A	A	—	—	
Photographic Solutions	D	D	A	B2	B	A	A	A1	A1	A2	A2	A	A	B2	D	A1	A1	A2	—	B	B1	—	A	A2	B1	D	—	—	—	—	—	D	D	D	B2	A	A	A	A	—	—	
Phthalic Acid	B	C	D	—	—	B	B2	—	B1	—	—	A2	A	A2	D	D	A	—	—	—	—	—	B1	D	A1	B2	A	B2	—	—	—	—	—	C	C	B2	A	A	A	—	—	
Phthalic Anhydride	B	C	D	—	—	—	—	—	A1	D	—	A	A	A	D	D	A	—	—	—	—	—	—	D	A	A	A	A	—	—	—	—	—	C	C	B2	A	A	A	—	—	
Picric Acid	A	A	D	A	—	D	A	—	C1	D	B1	A	A	D	A1	C	B	—	—	D	A	D	—	A	A	A	B	A	C	—	—	—	—	—	A	B	A	A	A	—	—	
Plating Solutions																																										
Antimony Plating 130°F	—	A	A	B	—	—	—	A	D	—	A	A	A	A	A	—	—	—	—	A	—	—	—	—	A	A	A	A	—	A	A	A	—	A	A	—	A	A	—	—	—	
Arsenic Plating 110°F	—	A	A	B	—	—	—	—	A	—	A	A	A	A	A	—	—	—	—	A	—	—	—	—	A	A	A	A	—	A	A	A	—	A	A	—	A	A	—	—	—	
Brass Plating:																																										
Regular Brass Bath 100°F	—	A	A	B	—	—	B	A	A	—	A	A	A	B	A	—	—	—	—	A	—	—	—	—	A	A	A	A	—	A	A	A	—	A	A	—	A	A	—	—	—	
High-Speed Brass Bath 110°F	—	A	A	B	—	—	B	A	A	—	A	A	A	B	A	—	—	—	—	A	—	—	—	—	A	A	A	A	—	A	A	A	—	A	A	—	A	A	—	—	—	
Bronze Plating:																																										
Cu-Cd Bronze Bath R.T.	—	A	A	B	—	—	—	A	A	—	A	A	A	A	A	—	—	—	—	A	—	—	—	—	A	A	A	A	—	A	A	A	—	A	A	—	A	A	—	—	—	
Cu-Sn Bronze Bath 160°F	—	B	D	C	—	—	—	A	A	—	A	A	D	A	A	—	—	—	—	A	—	—	—	—	A	A	A	A	—	A	A	A	—	A	A	—	A	A	—	—	—	
Cu-Zn Bronze Bath 100°F	—	A	A	B	—	—	—	A	A	—	A	A	A	A	A	—	—	—	—	A	—	—	—	—	A	A	A	A	—	A	A	A	—	A	A	—	A	A	—	—	—	
Cadmium Plating:																																										
Cyanide Bath 90°F	—	A	A	B	—	—	—	A	A	—	A	A	A	A	A	—	—	—	—	A	—	—	—	—	A	A	A	A	—	A	A	A	—	A	A	—	A	A	—	—	—	
Fluoroborate Bath 100°F	—	C	A	B	—	—	—	A	D	—	A	A	A	A	A	B	—	—	—	A	—	—	—	—	A	A	A	A	—	A	A	A	—	A	A	—	A	A	—	—	—	
Chromium Plating:																																										
Barril Chrome Bath 95°F	—	D	A	C	—	—	—	D	D	—	A	—	A	A	C	D	—	—	—	D	—	—	—	—	A	A	A	—	D	A	—	—	—	—	D	C	—	D	C	—	—	
Black Chrome Bath 115°F	—	D	A	C	—	—	—	D	D	—	A	—	A	A	C	C	—	—	—	D	—	—	—	—	A	A	A	—	D	A	—	—	—	—	C	A	—	—	—	—		
Chromic-Sulfuric Bath 130°F	—	D	A	C	—	—	—	D	D	—	A	—	A	A	C	D	—	—	—	D	—	—	—	—	A	A	A	—	D	A	—	—	—	—	C	A	—	—	—	—		
Fluoride Bath 130°F	—	D	A	C	—	—	—	D	D	—	A	—	A	A	C	D	—	—	—	D	—	—	—	—	A	A	A	—	D	A	—	—	—	—	C	A	—	—	—	—		
Fluosiilicate Bath 95°F	—	D	A	C	—	—	—	D	D	—	A	—	A	A	C	D	—	—	—	D	—	—	—	—	A	A	A	—	D	A	—	—	—	—	C	A	—	—	—	—		
Copper Plating (Cyanide):																																										
Copper Strike Bath 120°F	—	A	A	B	—	—	—	A	A	—	A	—	A	A	B	A	—	—	—	A	—	—	—	—	A	A	A	—	A	A	—	—	—	—	A	—	A	—	—	—	—	
High-Speed Bath 180°F	—	B	D	C	—	—	—	A	A	—	A	—	A	D	A	A	—	—	—	B	—	—	—	—	A	A	A	—	A	A	—	—	—	—	A	—	A	—	—	—	—	
Rochelle Salt Bath 150°F	—	B	D	C	—	—	—	A	A	—	A	—	A	D	A	A	—	—	—	B	—	—	—	—	A	A	A	—	A	A	—	—	—	—	A	—	A	—	—	—	—	
Copper Plating (Acid):																																										
Copper Fluoroborate Bath 120°F	—	C	A	D	—	—	—	A	D	—	A	—	A	A	A	B	—	—	—	C	—	—	—	—	A	A	D	A	—	D	A	—	—	—	D	D	—	D	A	—	—	
Copper Sulfate Bath R.T.	—	A	A	D	—	—	—	A	D	—	A	—	A	A	A	A	—	—	—	A	—	—	—	—	A	A	D	A	—	D	A	—	—	—	D	D	—	D	A	—	—	
Copper Plating (Misc):																																										
Copper Pyrophosphate	—	A	A	B	—	—	—	A	A	—	A	—	A	A	A	A	—	—	—	A	—	—	—	—	A	A	A	—	A	A	—	—	—	—	A	—	A	—	—	—	—	
Copper (Electroless)	—	D	A	B	—	—	—	A	A	—	A	—	A	A	A	D	—	—	—	D	—	—	—	—	A	A	A	—	A	A	—	—	—	—	A	—	A	—	—	—	—	
Gold Plating:																																										
Acid 75°F	—	—	A	A	—	—	—	A	A	—	A	—	A	A	—	—	—	—	A	—	—	—	—	—	A	—	C	—	—	—	—	—	—	—	—	—	—	A	A	—	—	
Cyanide 150°F	—	—	D	D	—	—	—	A	A	—	A	—	A	D	—	—	—	—	A	—	—	—	—	—	A	—	C	—	—	—	—	—	—	—	—	—	—	—	A	A	—	—
Neutral 75°F	—	—	A	A	—	—	—	A	A	—	A	—	A	A	—	—	—	—	A	—	—	—	—	—	A	—	C	—	—	—	—	—	—	—	—	—	—	—	A	A	—	—
Indium Sulfamate Plating R.T.	—	—	A	A	—	—	—	A	D	—	A	—	A	A	—	—	—	—	A	—	—	—	—	—	A	—	C	—	—	—	—	—	—	—	—	—	—	—	A	A	—	—
Iron Plating:																																										
Ferrous Am Sulfate Bath 150°F	—	—	D	D	—	—	—	A	D	—	A	—	A	D	—	—	—	—	B	—	—	—	—	—	A	—	C	—	—	—	—	—	—	—	—	—	A	A	—	—		
Ferrous Chloride Bath 190°F	—	—	D	D	—	—	—	A	D	—	A	—	A	D	—	—	—	—	B	—	—	—	—	—	A	—	C	—	—	—	—	—	—	—	—	—	—	A	A	—	—	
Ferrous Sulfate Bath 150°F	—	—	D	D	—	—	—	A	D	—	A	—	A	D	—	—	—	—	B	—	—	—	—	—	A	—	C	—	—	—	—	—	—	—	—	—	—	A	A	—	—	
Fluoroborate Bath 145°F	—	—	D	D	—	—	—	A	D	—	A	—	A	D	—	—	—	—	B	—	—	—	—	—	A	—	C	—	—	—	—	—	—	—	—	—	—	A	A	—	—	
Sulfamate 140°F	—	—	D	D	—	—	—	A	D	—	A	—	A	D	—	—	—	—	B	—	—	—	—	—	A	—	C	—	—	—	—	—	—	—	—	—	—	A	A	—	—	
Sulfate-Chloride Bath 160°F	—	—	D	D	—	—	—	A	D	—	A	—	A	D	—	—	—	—	B	—	—	—	—	—	A	—																





To find the safest materials for your application, search this database by chemical, material, or compatibility level.



Scan the QR code at right with your mobile device to get to our chemical compatibility database.

## CHEMICAL RESISTANCE CHARTS

### WARNING

The information in this chart has been supplied to Cole-Parmer by other reputable sources and is to be used **ONLY** as a guide in selecting equipment for appropriate chemical compatibility. Before permanent installation, test the equipment with the chemicals under the specific conditions of your application. Ratings of chemical behavior listed in this chart apply to a 48-hour exposure period; Cole-Parmer has no knowledge of possible effects beyond this period. Cole-Parmer does not warrant (neither expressed nor implied) that the information in this chart is accurate or complete or that any material is suitable for any purpose.

### DANGER

Variations in chemical behavior due to factors such as temperature, pressure, and concentration can cause equipment to fail, even though it passed an initial test.

#### SERIOUS INJURY MAY RESULT.

Use suitable guards and/or personal protection when handling chemicals.

### RATINGS

#### Chemical Behavior

- A – No effect
- B – Minor effect
- C – Moderate effect
- D – Severe effect; not recommended
- No data available

CHEMICAL	Plastics										Elastomers							Metals					Nonmetals																				
	ABS plastic	Acetal	CPVC	Epoxy	Hytral®	HDPE	LDPE	Noryl®	Nylon	Polycarbonate	Polypropylene	PPS	PTEF	PVC	PVDF	Nitrile (Buna N)	EPDM	Hypalon®	Kel-F®	Natural rubber	Neoprene	Santoprene®	Silicone	Tygon®	Viton®	304 stainless steel	316 stainless steel	Aluminum	Brass	Bronze	Carpenter 20	Cast Iron	Copper	Hastelloy C®	Titanium	Carbon graphite	Ceramic Al <sub>2</sub> O <sub>3</sub>	Ceramic magnet					
Stannic Chloride	—	C	A <sup>2</sup>	A	—	—	A <sup>2</sup>	A <sup>1</sup>	B <sup>1</sup>	A <sup>1</sup>	A	A	A <sup>2</sup>	A	A	A	C <sup>1</sup>	A	A	C <sup>1</sup>	—	B	—	A	D	D	D	—	A	D	D	D	—	B	A	A	A	A	—	—			
Stannic Fluoroborate	—	A	A <sup>2</sup>	A	—	—	B <sup>2</sup>	A <sup>2</sup>	C <sup>1</sup>	—	A	A <sup>1</sup>	A	A	A	A	C	A <sup>1</sup>	A	A	A <sup>1</sup>	—	B	A	A	C <sup>2</sup>	A <sup>2</sup>	D	—	A <sup>1</sup>	D	D	—	B	A	A	A	A	—	—			
Stannous Chloride	—	A	A	A	C	—	—	A <sup>2</sup>	A <sup>1</sup>	—	A	A	A	A	A	A	A	A	A	A	A <sup>1</sup>	—	B	A	A	A	A	D	—	A <sup>1</sup>	D	D	—	B	A	A	A	A	—	—			
Starch	—	A	A	A	—	—	—	A <sup>2</sup>	A <sup>1</sup>	—	A	A	A	A	A	A	A	A	A	A	A <sup>1</sup>	—	B	A	A	A	A	D	—	A <sup>1</sup>	D	D	—	B	A	A	A	A	—	—			
Stearic Acid	—	A	B <sup>2</sup>	B	C	A	B <sup>1</sup>	A	A <sup>2</sup>	A <sup>1</sup>	—	A	A	B <sup>2</sup>	A	B	C	—	—	—	A	B	D	A <sup>1</sup>	B	A	A	D	—	A <sup>1</sup>	D	D	—	B	A	A	A	A	—	—			
Stoddard Solvent	B	A	C <sup>1</sup>	A	—	—	C <sup>2</sup>	D	A	A <sup>2</sup>	C	A	A	C <sup>1</sup>	A	D	D	—	A	D	C <sup>1</sup>	D	D	C	A	A	A	A	A	A	A	A	A	A	A	A	A	A	—	—			
Styrene	B	A	D	A	D	—	—	—	A <sup>2</sup>	A <sup>1</sup>	—	A	A	D	A	D	D	—	A	D	D	D	D	B	A	A	A	A	A	A	A	A	A	A	A	A	A	A	A	—	—		
Sugar (Liquids)	B	A	—	A	—	—	—	—	A <sup>2</sup>	A <sup>1</sup>	—	A	A	A	A	A	A	—	A	A	A	D	—	B	B	B	D	—	A	A	A	A	A	A	A	A	A	A	A	—	—		
Sulfate (Liquors)	—	D	B	A	—	—	A	A <sup>2</sup>	A <sup>1</sup>	—	A	A	B	A	A <sup>2</sup>	A	B	—	—	—	B	B	—	A	A <sup>1</sup>	B	B	D	—	A	A	A	A	A	A	A	A	A	—	—			
Sulfur Chloride	—	D	C <sup>1</sup>	C	—	—	C <sup>1</sup>	A	A	C <sup>1</sup>	—	A	A	C <sup>1</sup>	A <sup>1</sup>	D	D	—	A	D	D	—	C	D	A	D	D	D	—	A	A	A	A	A	A	A	A	A	A	—	—		
Sulfur Dioxide	D	B	A <sup>2</sup>	A <sup>1</sup>	C	D	B <sup>1</sup>	A	C <sup>1</sup>	A <sup>1</sup>	—	A <sup>1</sup>	A	A	A	D	A <sup>2</sup>	C	A	—	B	—	B	A	A	D	A <sup>1</sup>	B	D	B	B	A	A	—	B	C	A	A	A	—	—		
Sulfur Dioxide (dry)	—	B	A <sup>2</sup>	A <sup>1</sup>	C	A	A <sup>1</sup>	A	B <sup>1</sup>	A <sup>1</sup>	A	A	A	A <sup>2</sup>	B	B	B	—	A	C	D	—	B	A	A	D	A	B	D	B	A	A	—	B	A	A	A	A	—	—			
Sulfur Hexafluoride	—	—	—	—	—	—	B	B	B	—	—	—	B	B	B	B	B	—	—	D	A	—	B	B	A	A	D	A	B	D	B	A	A	—	B	A	A	A	A	—	—		
Sulfur Trioxide	—	—	A	A	—	—	—	D	D	—	C	—	A	A	A	D	D	—	—	C	D	—	B	A	A	A	C	A	D	C	B	A	A	—	B	A	A	A	A	—	—		
Sulfur Trioxide (dry)	—	D	A	A	—	—	C <sup>1</sup>	D	A <sup>1</sup>	D	A	—	A	A <sup>1</sup>	C <sup>1</sup>	D	D	—	—	—	D	—	B	A	A	D	A	A	A	A	A	A	A	A	A	A	A	A	A	—	—		
Sulfuric Acid (<10%)	B	D	A	A <sup>1</sup>	A	A	A <sup>1</sup>	A	C <sup>1</sup>	A <sup>1</sup>	A <sup>2</sup>	A	A	A <sup>1</sup>	A <sup>1</sup>	A	A	A	A <sup>1</sup>	B <sup>2</sup>	A	C	A	A	A	A	D	B	D	C	—	B	D	C	—	B <sup>1</sup>	D	A <sup>1</sup>	A	—	—		
Sulfuric Acid (10-75%)	B	D	—	—	—	—	A	A <sup>1</sup>	A	D	B <sup>1</sup>	A	A	A <sup>1</sup>	A	B <sup>2</sup>	A	A	A	C	B <sup>1</sup>	B	D	C	A <sup>2</sup>	D	D	D	—	B	A <sup>2</sup>	D	D	—	B <sup>1</sup>	D	D	C <sup>1</sup>	A	—	—		
Sulfuric Acid (75-100%)	—	—	C	C <sup>1</sup>	C	B	C	A	D	D	C <sup>1</sup>	A <sup>1</sup>	A	D	A	C	C	B <sup>1</sup>	A	D	D	D	D	A <sup>2</sup>	B	C	D	B	B	—	B	A <sup>2</sup>	D	—	A <sup>1</sup>	D	D	D	A	—	—		
Sulfuric Acid (cold concentrated)	—	—	D	D	B	B	D	A	D	A <sup>2</sup>	A <sup>1</sup>	A	D	D	A	C	A	A	D	D	D	D	D	B	C	D	B	B	—	B	D	D	—	B	A	A	A	A	—	—			
Sulfuric Acid (hot concentrated)	—	—	D	D	—	—	—	D	D	D	D	A	D	D	A	C	D	D	—	—	D	—	D	A <sup>2</sup>	D	C	D	B	—	B	D	D	—	B	A	A	A	A	—	—			
Sulfurous Acid	—	C	A <sup>2</sup>	A	—	B	B <sup>1</sup>	A	D	—	A	A	A <sup>2</sup>	A	B <sup>1</sup>	B	B	—	—	D	B	A	B <sup>1</sup>	B	B <sup>1</sup>	B	B <sup>1</sup>	—	B	D	D	D	—	B	A	A	A	A	—	—			
Sulfuryl Chloride	—	A	—	—	—	—	—	—	—	—	—	—	—	—	—	—	—	—	—	—	—	—	—	—	—	—	—	—	—	—	—	—	—	—	—	—	—	—	—	—	—		
Tallow	—	A	—	—	—	A	C	A	A <sup>1</sup>	—	A <sup>2</sup>	—	—	—	—	—	—	—	—	B	—	—	—	A	A	A	—	—	—	—	—	—	—	—	—	—	—	—	—	—	—		
Tannic Acid	—	B	A <sup>1</sup>	A	A	A	B <sup>2</sup>	A <sup>2</sup>	C <sup>1</sup>	C	A	A	A	A <sup>1</sup>	B	A	A	A	A	A	A	C	C	A	A	A <sup>2</sup>	A	C	A	C	A	—	B	A	A	—	B <sup>1</sup>	A	A	A	A	—	—
Tanning Liquors	—	B	A <sup>1</sup>	A	—	—	A <sup>1</sup>	A <sup>2</sup>	A <sup>1</sup>	—	A <sup>1</sup>	—	A	A <sup>1</sup>	—	B <sup>1</sup>	B	B	—	C	A	—	B	A	A	A <sup>2</sup>	A	B	A	—	A <sup>2</sup>	A	—	A	—	B	A	A	A	A	—	—	
Tartaric Acid	—	B	A <sup>1</sup>	A	C	A	A <sup>1</sup>	A <sup>1</sup>	B <sup>2</sup>	—	A	A	A	A	B	A	B	A	A <sup>2</sup>	A	A <sup>2</sup>	A	B	A	A	C <sup>2</sup>	C <sup>2</sup>	B <sup>1</sup>	D	B <sup>1</sup>	A	C	A	A	A	A	A	A	A	A	—	—	
Tetrachloroethane	—	A	C	A	—	—	D	D	C <sup>1</sup>	—	C	—	A	C	D	D	D	—	—	—	D	D	—	—	—	—	—	—	—	—	—	—	—	—	—	—	—	—	—	—	—	—	
Tetrachloroethylene	—	A	C	A	—	C	B	D	C <sup>1</sup>	D	D	—	A	D	D	D	D	—	—	—	D	D	—	—	—	—	—	—	—	—	—	—	—	—	—	—	—	—	—	—	—	—	
Tetrahydrofuran	—	A	D	A	B	C	C <sup>1</sup>	D	D	A	D	C <sup>2</sup>	A	A	D	D	D	—	—	—	D	D	—	—	—	—	—	—	—	—	—	—	—	—	—	—	—	—	—	—	—	—	
Tin Salts	—	—	—	—	—	—	—	—	—	—	—	—	—	—	—	—	—	—	—	—	—	—	—	—	—	—	—	—	—	—	—	—	—	—	—	—	—	—	—	—	—	—	
Toluene (Toluol)	D	C <sup>1</sup>	D	B <sup>1</sup>	B	D	C <sup>1</sup>	D	A <sup>1</sup>	D	C <sup>1</sup>	A	A	D	A <sup>1</sup>	D	D	B <sup>2</sup>	D	D	D	D	D	A	A	A	A	A	A	A	A	A	A	A	A	A	A	A	A	A	—	—	
Tomato Juice	B	B	—	—	—	A	A <sup>1</sup>	A	A <sup>1</sup>	A <sup>1</sup>	A	A	A	A	A	A	—	—	—	A	—	—	—	—	—	—	—	—	—	—	—	—	—	—	—	—	—	—	—	—	—	—	
Trichloroacetic Acid	—	—	—	—	—	C	A	—	C	D	A	A	A	B	A	—	B	—	—	A	C	D	—	D	A	C	D	D	—	A	A	C	—	D	D	B	D	A	A	A	—	—	
Trichloroethane	—	A	—	—	—	—	D	D	C <sup>1</sup>	D	C	—	A	C	D	D	D	—	—	—	A	D	D	D	D	A	B	B	D	—	A	A	B	—	A	A	A	A	A	A	A	—	—
Trichloroethylene	D	D	D	C <sup>1</sup>	C	D	D	D	C <sup>1</sup>	—	C <sup>1</sup>	A <sup>1</sup>	—	—	—	D	D	—	—	D	D	—	—	—	—	—	—	—	—	—	—	—	—	—	—	—	—	—	—	—	—	—	
Trichloropropane	D	A	—	A	—	—	D	—	—	—	—	A <sup>1</sup>	—	—	D	—	—	—	A	D	A	—	—	D	A	A	A	D	—	A <sup>2</sup>	A	A	A	A	A	A	A	A	A	A	—	—	
Tricresylphosphate	B	C	D	A	—	—	B <sup>1</sup>	A	A <sup>2</sup>	—	A <sup>1</sup>	—	A	D	D	A	—	—	A	D	—	B	C	—	C	D	A	A	D	—	A <sup>2</sup>	A	A	A	A	A	A	A	A	A	—	—	
Triethylamine	—	D	A	A	—	—	B	A <sup>1</sup>	—	D	—	A	B	A <sup>2</sup>	C	A	—	—	A	B	—	—	—	D	A	A	A	—	—	—	—	—	—	—	—	—	—	—	—	—	—	—	
Trisodium Phosphate	D	A	A	A	A	A	A	A	A	A	A	A	A	A	A	A	—	—	—	A	D	—	A	A	A	A	B	D	—	A	C	—	B	A	—	B <sup>1</sup>	A	A	A	A	—	—	
Turpentine	B <sup>1</sup>	A <sup>2</sup>	A	B	—	B	D	D	B	D	A	A	A	D	A	—	D	D	A	D	D	D	D	A	A	A	A	A	A	D	A	A	—	A	—	C	—	B	B	A	A	—	—
Urea	B	A	A	—	—	A	A	A	D	A	A	A	D	A	B	A	—	—	—	B	—	B	B	A	B	B	B	B	—	B	—	—	—	—	—	—	—	—	—	—	—	—	
Uric Acid	—	—	—	—	—	B	—	A	—	—	—	—	—	—	—	—	—	—	—	A	—	—	—	—	—	—	—	—	—	—	—	—	—	—	—	—	—	—	—	—	—	—	
Urine	—	A	A	A	—	A	A <sup>2</sup>	A <sup>2</sup>	B	—	A <sup>2</sup>	—	A	A	A	A <sup>1</sup>	A <sup>1</sup>																										



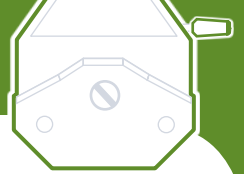

<b>12- and 24-VDC pump drives</b> ..... 107	<b>Chemical compatibility, tubing</b> ..... 30-31	Portable samplers..... 104-107	<b>I/P® Pumps</b>
<b>56C-face motors</b> ..... 103, 145, 159	<b>Chemical resistance charts</b> ..... 198-206	Remote control .... 78-81, 84-95, 98-99	Air-powered drives ..... 142
<b>Accessories</b>	<b>C/L® Tubing Pumps</b>	Variable-speed ..... 78-95, 98-99, 101-102	Analog drives ..... 134-137
BarbLock™ tubing	Tubing, microbore..... 34, 36	Washdown process ..... 86-87, 90-93	ATEX pump system ..... 151
retainers..... 166	Variable-speed pumps..... 34-37	Programmable..... 94-95, 98-99	Console drives..... 134-137, 140-141
Cord/plug assemblies ..... 171	<b>Clamps, tubing</b> ..... 166-167	Sampling..... 104-107	Digital drives..... 138-141
Dispensing nozzles..... 167	<b>Composite sampler</b> ..... 106	Selection guides	Dispensers ..... 138-141
Fittings ..... 162-167	<b>Computer-compatible drives, L/S®</b> ..... 94-95	B/T® ..... 152	Easy-Load® pump heads ..... 122-123
Fuses ..... 171	<b>Console drives</b>	I/P® ..... 131	Fixed-speed drives ..... 143
Liqui-Sense® fluid monitoring system ..... 160-161	I/P® ..... 134-137, 140-141	L/S® ..... 74-75	Hazardous-duty drives ..... 144
Microbore tubing	L/S® ..... 76-85, 88-89, 92-95	Washdown ..... 86-87, 90-93, 132-141, 154-158	High-Performance pump head..... 124-125
connectors ..... 163	<b>Conversion factors</b> ..... 197	Water sampling ..... 104-107	Modular drives ..... 132-133, 138-139
Mounting hardware ..... 168-169	<b>Cord and plug sets</b> ..... 171	<b>Easy-Load® pump heads</b>	Multichannel pump system... 150
Pinch valves..... 166-167	<b>DC-powered drives</b> ..... 107	I/P® ..... 122-123	Pump heads
Quick-disconnect couplings..... 164-165	<b>Detector, fluid/leak, Liqui-Sense®</b> ..... 160-161	L/S® ..... 46-47	Easy-Load® ..... 122-123
Replacement parts ..... 168-171	<b>Digi-Staltic® dispensing pumps</b> ..... 98-99	<b>Easy-Load® II pump heads</b> ..... 44-45	High-Performance ..... 124-125
Tubing clamps ..... 166-167	<b>Digi-Staltic® software</b> ..... 100	<b>Easy-Load® 3 pump heads</b> ..... 42-43	Standard..... 120-121
Tubing cutters ..... 162	<b>Digital drives</b>	<b>Emergency fluid cut-off system</b> ..... 160-161	Remote control drives .... 132-141
Tubing weights..... 167	B/T® ..... 156-157	<b>Enclosure ratings, NEMA/IEC</b> ..... 194	Replacement parts ..... 169
<b>Adapters</b>	I/P® ..... 138-141	<b>E/S® sampling pumps</b> ..... 104-106	Stainless steel drive ..... 140-141
Micropump® ..... 62	L/S® ..... 84-95, 98-99	<b>Fittings</b>	Standard pump heads ... 120-121
Piston pump head ..... 67	<b>Dispensers</b>	BarbLock™ retainers..... 166	Systems ..... 146-151
Pump head to 56C-face motor	I/P® ..... 138-141	Hose barb..... 162-165	Tubing ..... 126-130
I/P® ..... 145	L/S® ..... 88-95, 98-99	Microbore tubing ..... 163	Variable-speed drives..... 132-142, 144
L/S® ..... 103	<b>Dispensing nozzles</b> ..... 167	Quick disconnect ..... 164-165	Washdown drives ..... 132-141
<b>Air-powered drives</b>	<b>Drives</b>	Sanitary..... 72, 129	<b>I/P® Tubing</b>
B/T® ..... 154-155	Air-powered	<b>Fixed-speed drives</b>	Bulk-packed ..... 130
I/P® ..... 142	B/T® ..... 154-155	B/T® ..... 158	High-performance precision..... 128
L/S® ..... 101	I/P® ..... 142	I/P® ..... 143	Precision ..... 126-127
<b>Analog drives</b>	L/S® ..... 101	L/S® ..... 76-77	Sanitary assemblies..... 129
B/T® ..... 154-155	B/T®	<b>Float switch, level sensor</b> ..... 161	Spooled..... 130
I/P® ..... 134-137	Air-powered ..... 154-155	<b>Fluid monitoring system, Liqui-Sense®</b> ..... 160-161	<b>Ismatec® pump heads</b> ..... 66
L/S® ..... 76-83, 101-107	ATEX ..... 154-155	<b>Food-grade tubing</b>	<b>Liqui-Sense® monitoring system</b> ..... 160-161
<b>Application tips</b> ..... 33, 188-191	Analog ..... 154-155	Norprene® ..... 67, 69, 71, 127-128, 153	<b>L/S® Pump Heads</b>
<b>Applications</b> ..... 6-17	Digital ..... 156-157	Tygon® E-Food ... 69, 71, 127, 153	ATEX ..... 46-49
<b>ATEX</b>	Fixed-speed..... 158	<b>Frequently asked questions</b> ..... 17	Cartridge ..... 56-59
Hazardous area classifications ..... 195	Variable-speed ..... 154-157	<b>Fuses</b> ..... 171	Diaphragm ..... 60-61
Pump heads..... 46-49, 122-125	Washdown ..... 154-158	<b>Gear pumps</b>	Easy-Load® ..... 46-47
Pump systems ..... 117, 151, 154-155	C/L® ..... 34-37	Adapter for L/S® drives..... 62	Easy-Load® II ..... 44-45
<b>Barbed fittings</b> ..... 162-165	Computer-compatible ..... 94-95	Drives ..... 63-64	Easy-Load® 3 ..... 42-43
<b>BarbLock™ tubing retainers</b> ..... 166	DC-powered..... 107	Heads, Micropump® ..... 62	High-Performance ..... 48-49
<b>BioPharm platinum-cured silicone tubing</b> ..... 68, 70, 73, 126, 128, 130	Dispensing ..... 88-95, 98-99, 138-141, 156-157	Systems ..... 65	Multichannel ..... 52-55
<b>BioPharm Plus platinum-cured silicone tubing</b> ..... 68, 70, 126, 128, 153	Hazardous-duty ..... 101-102, 142, 144, 154-155	<b>GORE® tubing</b>	Multichannel cartridge..... 56-59
<b>B/T® Pumps</b>	I/P®	Style 100SC... 69-71, 127-128, 153	PTFE-diaphragm..... 60-61
Air-powered pumps ..... 154-155	Air-powered ..... 142	Style 400 ..... 69-71, 127-128, 153	PTFE-tubing ..... 50-51
Analog pumps ..... 154-155	Analog ..... 134-137	Style 500 ..... 69-71, 127-128	Replacement parts ..... 168
ATEX approved ..... 154-155	ATEX ..... 142	<b>Hazardous area classifications</b>	Selection guide..... 38-39
Digital pumps ..... 156-157	Console..... 134-137	ATEX ..... 195	Standard ..... 40-41
Fixed-speed pumps..... 158	Digital ..... 138-141	NEC..... 195	<b>L/S® Pumps</b>
Modular pumps ..... 154-157	Dispensers..... 138-141	<b>Hazardous-duty drives</b> ..... 101-102, 142, 144, 154-155	Air-powered drive ..... 101
PerfectPosition™ tubing..... 153	Fixed-speed..... 143	<b>High-Performance pump heads</b>	Analog drives ..... 76-83, 101-107
Pump heads..... 159	Hazardous-duty..... 142, 144	I/P® ..... 124-125	ATEX pump system ..... 117
Remote control..... 156-157	Modular ..... 132-133, 138-139	L/S® ..... 48-49	Cartridge pump heads ..... 56-59
Selection guide..... 152	Remote control ..... 132-141	<b>High-performance Precision tubing</b>	Compact drives ..... 78-81
Tubing ..... 153	Stainless steel ..... 140-141	B/T® ..... 153	Compact pump..... 78-79
Variable-speed pumps.... 154-157	Variable-speed ..... 132-142, 144	I/P® ..... 128	Computer-compatible drives..... 94-95
Washdown pumps ..... 154-158	Washdown ..... 132-141	L/S® ..... 70-71	Console drives..... 76-85, 88-89, 92-95
<b>Bulk-packed tubing</b> ..... 73, 130	L/S®	<b>High-pressure pump system, L/S®</b> ..... 117	DC-powered drives ..... 107
<b>Cables</b>	Air-powered ..... 101	<b>High-pressure tubing</b> ..... 49	Diaphragm pump heads..... 60-61
Balance interface..... 100	Analog ..... 76-83, 101-107	<b>Hose barb fittings</b> ..... 162-165	Digital drives..... 84-95, 98-99
RS-232 interface ..... 111	ATEX ..... 101	<b>IEC enclosure ratings</b> ..... 194	Dispensers ..... 88-95, 98-99
Serial ..... 111	Compact ..... 78-81	<b>Ingress Protection (IP) ratings</b> ... 194	Easy-Load® pump heads .... 46-47
USB interface..... 111	Computer-compatible ..... 94-95	<b>I/P® Pump Heads</b>	Easy-Load® II pump heads ..... 44-45
<b>Cartridge pump heads, L/S®</b> ..... 56-59	Console..... 76-85, 88-89, 92-95	ATEX ..... 122-125	Easy-Load® II pump heads ..... 44-45
<b>C-FLEX® tubing</b> ..... 34, 36, 68, 70, 73, 126, 128, 130, 153	DC-powered ..... 107	Easy-Load® ..... 122-123	Easy-Load® 3 pump heads ..... 42-43
<b>C-Flex® ULTRA tubing</b> ... 68, 70, 126	Digital ..... 84-95, 98-99	High-Performance..... 124-125	Easy-Load® 3 pump heads ..... 42-43
<b>Chem-Durance® Bio tubing</b> ..... 69, 71, 127-128, 153	Dispensers..... 88-95, 98-99	Replacement parts ..... 169	Economy drives..... 82-83
	Economy ..... 82-83	Selection guide..... 118-119	Fixed-speed drives..... 76-77
	Fixed-speed..... 76-77	Standard ..... 120-121	
	Hazardous-duty..... 101-102		
	Modular..... 86-87, 90-91, 98-99		

## INDEX

### L/S® Pumps (continued)

Hazardous-duty drives	101-102
High-Performance pump head	48-49
High-pressure pump system	117
High-pressure pump tubing	49
Microbore tubing	34, 36
Modular drives	86-87, 90-91, 98-99
Multichannel pump heads	52-55
Portable samplers	104-107
PTFE-diaphragm pump system	60, 116
PTFE-tubing pump system	51, 116
Pump heads	38-67
Remote control drives	78-81, 84-95, 98-99
Replacement parts	168-171
Sampling pumps	104-107
Selection guides	
Drives	74-75
Pump heads	38-39
Stainless steel drive	92-93
Standard pump heads	40-41
Systems	108-117
Tubing	68-73
Variable-speed drives	78-95, 98-99, 101-102
Washdown process drive	86-87, 90-93

### L/S® Tubing

Bulk-packed	73
High-Performance Precision	70-71
Precision	68-69
Sanitary assemblies	72
Spooled	73
Microbore tubing	34, 36
Microbore tubing connectors	163
Micropump®	
Adapter for L/S® drives	62
Compatible drives	63-64
Gear pump heads	62
Gear pump systems	65
Mixers, overhead	96-97
Motors	103, 145, 159
Mounting hardware	168-169
Multichannel pump heads, L/S®	52-55
Multichannel pump systems	
I/P®	150
L/S®	112-113
NEC hazardous area classifications	195
NEMA pump head adapters	103, 145
NEMA enclosure ratings	194
Norprene® food-grade tubing	69, 71, 73, 127-128, 130, 153
Norprene® tubing	49, 69, 71, 127-128
Nozzles, dispensing	167
OEM design/engineering services	5
Online tools and features	2-3
Parts, replacement	168-171
PerfectPosition™ pump tubing, B/T®	153
PharmaPure® tubing	68, 70, 126, 153
PharMed® BPT tubing	34, 36, 49, 68, 70, 72-73, 126, 128-130, 153
PharMed® BPT tubing, sanitary	72, 129
Pipe thread information	194

Piston pump head adapters	67
Plug and cord sets	171
Precision tubing	
B/T®	153
I/P®	126-127
L/S®	68-69
Programmable drives	94-95, 98-99
PTFE pump heads	
Diaphragm	60-61
Tubing	50-51
Pulse dampener	73
Pump comparisons	14-17
Pump head adapters for 56C-face motors	
I/P®	145
L/S®	103
Pump head technical data	181-187
Pump heads	
B/T®	159
Cartridge	56-59, 66
Diaphragm	60-61
Easy-Load®	
I/P®	122-123
L/S®	46-47
Easy-Load® II	44-45
Easy-Load® 3	42-43
Gear, Micropump®	62
High-Performance	
I/P®	124-125
L/S®	48-49
Ismatec®	66
L/S®	38-67
Minicartridge	66
Multichannel	52-55
Multichannel cartridge	56-59
Parts, replacement	168-169
Piston	67
PTFE-diaphragm	60-61
PTFE-tubing	50-51
Rapid-Load®	159
Selection guides	
I/P®	118-119
L/S®	38-39
Standard	
I/P®	120-121
L/S®	40-41
Pump systems	
B/T®	152-158
C/L®	34-37
I/P®	146-151
L/S®	108-117
Selection tips	18
Puri-Flex™ tubing	34, 36, 68, 70, 126, 128, 153
Quick-disconnect fittings	164-165
Rapid-Load® pump heads	159
Ratings, ATEX/IP/NEMA/IEC/NEC	194-195
Regulatory agencies and approvals	193
Replacement parts	168-171
Sampling drives	104-107
Sanitary	
Fittings	72, 129
Tubing assemblies	72, 129
Selection guides	
B/T® pumps	152
I/P® drives	131
I/P® pump heads	118-119
L/S® drives	74-75
L/S® pump heads	38-39
Sensors	
Float switch	161
Fluid leak	161
Level	161
Liqui-Sense®	160-161
ServoDyne™ mixers	96

### Silicone tubing

BioPharm Plus silicone (platinum-cured)	68, 70, 126, 128, 153
BioPharm silicone (platinum-cured)	68, 70, 73, 126, 128, 130
Bulk-packed	73, 130
Peroxide-cured	34, 36, 68, 70, 73, 126, 128, 130, 153
Platinum-cured	34, 36, 68, 70, 72-73, 126, 128-130, 153
Sanitary	72, 129
Spooled	73, 130
Spooled tubing	73, 130
Stainless steel process drives	
I/P®	140-141
L/S®	92-93
Standard pump heads	
I/P®	120-121
L/S®	40-41
Stir-Pak® mixers	97
Stirrers, overhead	96-97
Technical data	
Application tips	
Abrasive fluids	190
Dispensing	188-189
Viscous fluids	190-191
ATEX hazardous area classifications	195
Chemical resistance charts	198-206
Conversion factors	197
Glossary of terms	196
IEC enclosure ratings	194
Ingress protection (IP) ratings	194
NEC hazardous area classifications	195
NEMA ratings	194
Pump head data	
Flow rates	181-185
Pressure and suction lift	184-185
Torque requirements	186-187
Regulatory agencies/ approvals	193
Standard pipe threads	194
Tubing chemical compatibility	30-31
Tubing life data	
B/T®	179-180
I/P®	176-178
L/S®	173-175
Torque requirements, pump heads	186-187
Tubing	
Accessories	162-167
BioPharm Plus silicone (platinum-cured)	68, 70, 126, 128, 153
BioPharm silicone (platinum-cured)	68, 70, 73, 126, 128, 130
B/T®	153
Bulk-packed	73, 130
C-FLEX®	34, 36, 68, 70, 73, 126, 128, 130, 153
C-Flex® ULTRA	68, 70, 126
Chem-Durance® Bio	69, 71, 127-128, 153
Chemical compatibility tables	30-31
C/L®	34, 36
Clamps	166-167
Cutters	162
Fittings	162-166

Formulation descriptions	20-24
Formulation highlights	25-29
GORE®	
Style 100SC	69, 71, 127-128, 153
Style 400	69, 71, 127-128, 153
Style 500	69, 71, 127-128
High-Performance Precision	
B/T®	153
I/P®	128
L/S®	70-71
High-pressure	49
Introduction	19-31
I/P®	126-130
L/S®	68-73
Microbore	34, 36
Norprene®	69, 71, 127-128
Norprene® food	69, 71, 73, 127-128, 153
PerfectPosition™, B/T®	153
Peroxide-cured silicone	34, 36, 68, 70, 73, 126, 128, 130, 153
PharmaPure®	68, 70, 126, 153
PharMed® BPT	34, 36, 49, 68, 70, 72-73, 126, 128-130, 153
Platinum-cured silicone	34, 36, 68, 70, 72-73, 126, 128-130, 153
Precision	
B/T®	153
I/P®	126-127
L/S®	68-69
PTFE	50
Puri-Flex™ tubing	34, 36, 68, 70, 126, 128, 153
Sanitary tubing assemblies	72, 129
Silicone	
BioPharm	68, 70, 73, 126, 128, 130
BioPharm Plus	68, 70, 126, 128, 153
Peroxide-cured	34, 36, 68, 70, 73, 126, 128, 130, 153
Platinum-cured	34, 36, 68, 70, 72-73, 126, 128-130, 153
Spooled	73, 130
Technical data	20-31, 172-192
Tygon® Chemical	69, 71, 127
Tygon® E-Food	69, 71, 127-128, 153
Tygon® E-Lab	34, 36, 69, 71, 127-128
Tygon® E-LFL	34, 36, 69, 71, 127-128, 153
Tygon® Fuel & Lubricant	69, 71, 127
Viton®	34, 36, 69, 71, 127
Tubing chemical compatibility tables	30-31
Tubing life data	172-180
Tygon® tubing	34, 36, 69, 71, 127-128, 153
Variable-speed drives	
B/T®	154-157
C/L®	34-37
DC-powered	107
I/P®	132-142, 144
L/S®	78-95, 98-99, 101-102
Viton® tubing	34, 36, 69, 71, 127
Washdown drives	
B/T®	154-158
I/P®	132-141
L/S®	86-87, 90-93
Water sampling pumps	104-107

## NEW PRODUCT HIGHLIGHTS

### L/S® DIGITAL PROCESS DRIVES

- ▶ Sealed powder-coat steel housing is IP66 and NEMA 4X rated—spray or hose down to clean
- ▶ Intuitive graphical interface for easy setup and operation
- ▶ Dispense by volume, time, or copy; cumulative volume function totalizes volume dispensed over multiple batches
- ▶ Flow rates from 0.006 to 3400 mL/min with L/S pump tubing
- ▶ See pages 92–93



### I/P® DIGITAL MODULAR DISPENSING DRIVES

- ▶ Intuitive graphical interface for easy setup and operation
- ▶ Dispense by volume, time, or copy; cumulative volume and batch functions
- ▶ Modular format lets you place drive and controller where convenient
- ▶ Available with either a benchtop or washdown wall-mount controller
- ▶ Flow rates from 0.0006 to 19 LPM with I/P pump tubing
- ▶ See pages 138–139



### L/S® PRECISION MODULAR DRIVES

- ▶ Three-digit LED displays speed in rpm—ensures repeatable settings
- ▶ Modular format lets you place drive and controller where convenient
- ▶ Available with either a benchtop or washdown wall-mount controller
- ▶ Remote control of speed, start/stop, direction
- ▶ Flow rates from 0.06 to 3400 mL/min with L/S pump tubing
- ▶ See pages 86–87



### MASTERFLEX® TYGON® E-FOOD PUMP TUBING



- ▶ New non-DEHP formulation offers global approvals for the food, beverage, and sanitary industries
- ▶ Pumping life is second only to Masterflex Tygon E-LFL for the clear Tygon formulations
- ▶ Smooth inner bore resists entrapment of particles and contaminants
- ▶ Resistant to harsh cleaners, sanitizers; sterilize via EtO or autoclave
- ▶ Compliant with FDA, 3-A, EU Food, and NSF 51 standards
- ▶ See pages 22, 69, 71, 127–128, and 153

### CUSTOM CUT-TO-LENGTH TUBING SERVICE: SAVE TIME AND ENHANCE EFFICIENCY!

#### Tell us what tubing, how long, and how many pieces you need. We'll take care of the rest!

- ▶ Choose from our wide selection of tubing brands, formulations, and sizes
- ▶ Tubing lengths can be bulk or bagged, nonsterile, gamma irradiated, or even validated sterile
- ▶ We will provide you with samples to test in your application before you place an order

Contact a Cole-Parmer representative today at 866-802-0579 or go to [ColeParmer.com/ctl tubing](http://ColeParmer.com/ctl tubing) for more information.



# DISCOVER THE *MASTERFLEX*® ADVANTAGE!

## L/S® Modular Drives

See pages 86–87, 90–91



## Why we're tried, tested, and trusted around the world:

- ▶ Best value of peristaltic tubing pumps in the market
- ▶ Easy to install, operate, and maintain
- ▶ Contamination-free and easy to clean—simply change tubing
- ▶ Interchangeable pump heads to customize a single pump drive
- ▶ Wide selection of Masterflex pump tubing formulations and sizes

Compare  
Masterflex pumps  
to other pump  
technologies,  
see pages 14–17



## I/P® Modular Drives

See pages 132–133, 138–139