

Viscometry

VISCOSYSTEM® | AVS® | VISCOCLOCK | VISCOMETERS

SI Analytics

a **xylem** brand



Capillary viscometry from Xylem - know-how from the very beginning

Innovative capillary viscometry - from the outset

The viscosity of Newtonian fluids can be most precisely determined using capillary viscometers. This method of measurement, measures the time taken for a defined quantity of fluid to flow through a capillary with a known diameter and known length. With the industrial production of such precisely calibrated capillary viscometers, we have created the conditions to enable this measuring method to establish itself worldwide as a reliable procedure.

With the development of the first automatic measuring systems, we replaced the stopwatch with automatic registration of the fluid at the start of the 1970's.

To rule out systematic errors in automatic meniscus detection, viscometers are available which are specially calibrated for this type of automatic cycle time measurement and therefore comply with the relevant standard specifications.

In addition to automatic time measurement, AVS® measuring systems have further automations that make capillary viscometry much easier:

- Pneumatic pumping of the liquid in the viscometer, so that automatically repeated measurements can be carried out, from which an average value and the final result are calculated
- Waste system: Automatic emptying and flushing of viscometers
- The automatic filling of the viscometers on the AVS®Pro III automatic sampler

In addition to the accuracy of the measurement, all automated devices focus on user safety and the robustness of the system.

Further developments and improvements of viscometers, measuring instruments and accessories led to a range of products whose excellent performance is universally recognized. It is therefore no wonder that our viscosity measurement systems have become indispensable production control and quality insurance tools worldwide, whether in the mineral oil industry, for polymer manufacturers and processors, in the pharmaceutical or food industry.

Our capillary viscometers are the worldwide basis for precise viscosity measurements of Newtonian fluids.

Content

	Page
1. Measurement Devices	
1.1 Applications of the AVS® measurement systems	4
1.2 ViscoClock plus	6
1.3 ViscoPump III - The core of all AVS® systems	10
1.4 AVS® 470	12
1.5 AVS® 370	16
1.6 Software WinVisco 4	22
1.7 AVS® Pro III	26
1.8 CT 72 Thermostat Series - Transparent Thermostats conforming to Standards	34
2. Viscometer	
2.1 Viscometers and their range of use	38
2.2 Ubbelohde viscometers, normal form (DIN)	39
2.3 Ubbelohde viscometers, normal form (ASTM)	40
2.4 Ubbelohde viscometers, with additional tube and threads	41
2.5 Ubbelohde viscometers with TC sensors	42
2.6 Micro-Ubbelohde viscometers with TC sensors	44
2.7 Micro-Ubbelohde viscometers (DIN)	45
2.8 Cannon-Fenske viscometers	46
2.9 Ostwald Viscometer	48
3. Accessories	
3.1 Accessories for viscometers	49
3.1.1 Brackets and stands	49
3.1.2 Temperature stabilization jackets	51
3.1.3 LabPump	52
3.2 Accessories for measurement devices	52
3.2.1 Control thermometers	52
3.2.2 Safety devices	54
3.2.3 Filtration system ProClean II	56
3.2.4 Thermostat vessel for ViscoClock plus	57
3.2.5 Burette Titronic® 500 for sample preparation	58
3.2.6 AVS® measuring stands	60

1 Measurement Devices

1.1 Applications AVS® systems

AVS® measurement systems within quality assurance systems

Business sector	Product	Example
Automotive engineering	motor oil (fresh and used) uncured plastics	light weight construction parts
Brewery	original wort hop-wort	beer beer
Electrical engineering and electronics	uncured plastics of all types	chips, casings
Power supply	turbine oil transformer oil	generators
Plastics manufacturers	uncured plastics of all types	Polyamid (Nylon)
Plastics processors	uncured plastics of all types	injection moulding of polyester and polyamide
Food industry	starch	instant flour thickeners
	gelatin	jelly bears
	packaging materials	yogurt containers
	milk products	yogurt drink
	fruit and fruit juice concentrates gelatinizing agents	pectin
Aviation	uncured plastics of all types fuels hydraulic fluids	kerosene horizontal stabilizers and undercarriages
Mechanical engineering	mold oil hardening emulsions hydraulic fluids	mill trains stamp shops
Medicine	body fluids hyaluronic acid tinctures and drops blood substitute materials	blood, bile Na-Hyaluronat nose, eyes blood plasma
Mineral oil	light motor oil turbine oil liquid fuels of all types	gasoline, diesel fuel, kerosene (jet fuel)
Textile	uncured plastics of all types cotton	for mixed fibers
Entertainment	uncured plastics	CDs, DVDs made of polycarbonate

The table on the right illustrates the extensive area of high polymer plastics and the large variety of testing methods.

Polymer applications for the AVS® measurement systems

Recommended capillary sizes and AVS® measurement systems

For polymer analytics, mostly Ubbelohde viscometers are applied (type with suspended level). In general, viscometers according to DIN 53 000 as well as ASTM D446 can be used, as there is only a slight difference between both designs. Especially ISO standards for polymer analytic generally allow both designs. However, in case of ASTM standards, e.g. ASTM D4603, the ASTM viscometer design is more common.

Type	Abbr.	Solvent	Capillary size		Temperature	Operating Standards	Suitability of the AVS® measurement systems			
			DIN	ASTM			VC*	370	470	Pro III
Cellulose	CI	EWN Cuen (CED) Cuen (CED) Cuen (CED) Cuen (CED) Cuen (CED) Cuen (CED)			20 °C 20 °C 20 °C 25 °C 25 °C 25 °C 25 °C	SNV 195598 DIN EN 60450 ASTM D 4243 ISO 5351 ASTM; D 1795 SCAN CM 15:99 TAPPI T230-0M99	■	■	■	■
Cellulose acetate	CA	Dichlormethane/ methanol (90:10)	0c I I Micro	0C 1	25 °C	ASTM D817	■	■	■	■
Polyamide	PA	Sulphuric acid (96%)	II IIc	2 2C	25 °C	ISO 307	■	■	■	■
Polyamide	PA	Formic acid (90%)	I Ic	1 1C	25 °C	ISO 307	■	■	■	■
Polyamide	PA	m-cresol	II IIc	2 2C	25 °C	ISO 307	■	■	■	■
Polybutylene terephthalate	PBT	Phenol/dichloro benzene (50:50)	Ic II	1C 2	25 °C	ISO 1628-5	■	■	■	■
Polycarbonate	PC	Dichloromethane	0c I	0C 1	25 °C	ISO 1628-4	■	■	■	■
Polyethylene	PE	Decahydro- naphthalene	0a I	0B 1	135 °C	ISO 1628-3 ASTM D 1601	■	■	■	■
Polyethylene terephthalate	PET	Phenol/1,1,2,2- Tetrachlorethan (60:40)	Ia	1B	25 °C	ASTM D 4603	■	■	■	■
Polyethylene terephthalate	PET	m-cresol	II IIc IIc Micro	2 2C	25 °C	ISO 1628-5	■	■	■	■
Polyethylene terephthalate	PET	Phenol/dichloro benzene (50:50)	Ic II	1C 2	25 °C	ISO 1628-5	■	■	■	■
Polyethylene terephthalate	PET	Dichloroacetic acid	Ia II IIc Micro	1B	25 °C	ISO 1628-5	■	■	■	■
Polymethyl methacrylate	PMMA	Chloroform	0c I Micro	0C	25 °C	ISO 1628-6	■	■	■	■
Polypropylene	PP	Decahydro- naphthalene	0a I	0B 1	135 °C	ISO 1628-3	■	■	■	■
Polystyrene	PS	Toluene	I Ic	1 1c	25 °C		■	■	■	■
Polysulphone	PSU	Chloroform	0c	0C	25 °C		■	■	■	■
Polyvinyl chloride	PVC	Cyclohexanone	Ic	1C	25 °C	ISO 1628-2, ASTM D 1243	■	■	■	■
Styrene-acrylo-nitrile copolymer	SAN	Ethyl methyl ketone	0c I		25 °C		■	■	■	■
Styrene-butadiene copolymer	SB	Toluene	0c I		25 °C		■	■	■	■

■ excellent suitability ■ can be used ■ limited suitability for application related reasons

This table makes no claim to completeness.

VC* = ViscoClock plus

The highlighted capillary size is specified in the standard

Measurement Devices

1.2 ViscoClock plus

Measurement plus data storage

The ViscoClock plus is an electronic timing unit for glass capillary viscometers used to determine kinematic and relative viscosity. Succeeding the well-proven ViscoClock, the new instrument features data storage and simpler handling. The ViscoClock plus is especially designed for Ubbelohde type viscometers which are well-known for highest precision.

The ViscoClock plus

The ViscoClock plus automatically measures the flow time of temperature-stabilized liquids in capillary viscometers by means of infrared light barriers: the manual measurement with a stopwatch becomes obsolete.

The viscometer including a sample is inserted into the ViscoClock plus and immersed into a thermostatic bath for temperature stabilization. After thermostating, the sample is pumped into the measuring bulb, and the flow time is detected automatically. The large display enables easy read-off of flow times and additional information: date, time, sample ID and viscometer ID.



ViscoClock plus - Head



The viscometer stand: high-performance plastic PPA



Well arranged: The new display

Automatic measurement of flow times

The ViscoClock plus is designed for SI Analytics® Ubbelohde, Micro Ubbelohde and Micro Ostwald viscometers. The flow time is measured automatically by two infrared light barriers which detect the passing liquid meniscus. The repeatability of the automatic time measurement is considerably higher in comparison to the measurement using a stop watch. Therefore some viscometry standards allow a flow time reduction in case of automatic flow time measurement.

Properties and materials

The ViscoClock plus can be used for measuring temperatures ranging from -40 °C to 150 °C. The stand of the ViscoClock plus is made of high quality polymer PPA. For temperature stabilization in a thermostatic bath, the following liquids are suitable: Water, alcohol, glycol, paraffin oil, and silicon oil. The electronic measuring unit is built-in to a PP casing.

Easy handling

The ventilation of Ubbelohde viscometers is managed by an electromechanic valve which makes handling easier in comparison to the mechanical mechanism of the previous ViscoClock.

Data storage

The measuring results of the ViscoClock plus can be stored on a USB flash drive including date, time and sample/viscometer ID. The data are stored as pdf (non-editable) and csv (editable). Alternatively, for data transfer the ViscoClock plus can be connected to a printer (TZ 3863) or a PC.



- Automatic and precise flow time measurement for a low price
- Suitable for SI Analytics® Ubbelohde, Micro Ubbelohde and Micro Ostwald viscometers
- Data storage incl. time, date, viscometer and sample ID
- Stand is made of high performance engineering plastic PPA and enables measuring temperatures up to 150°C
- Electromagnetic venting valve for convenient handling of Ubbelohde viscometer
- Compatible with all SI Analytics® thermostatic bath types

Benefits
ViscoClock plus

ViscoClock *plus* - The *plus* for your measurements

Sample and viscometer identification

To allocate the stored measuring results, the user can enter 2-digit numbers to the ViscoClock *plus* before measurement. These IDs - together with date and time - ensure an unambiguous assignment of the flow times.

Absolute viscosity

To determine absolute kinematic viscosities, calibrated viscometers have to be used. To guarantee best accuracy, viscometers which were calibrated by automatic measurement should be used. The constant of automatic calibration can be slightly different in comparison to manual calibration, as the level of the light barriers may not be identical to the position of timing marks.

Relative viscosity

In the analytics of plastics, for evaluation the relative viscosity is calculated, and depending on this also viscosity number (VN), intrinsic viscosity (IV) or the K value according to Fikentscher. For determination of relative viscosities, calibrated as well as non-calibrated viscometers can be used. For evaluation, the calibration constant is not required in this case.

Ordering Information

Type No.	Order No.	Description	Page
ViscoClock <i>plus</i>	285417900	Timing unit for capillary viscometer. Including power supply 100-230V and hand pump	9
ViscoClock <i>plus</i> M1, 230V	285417910	ViscoClock <i>plus</i> and acrylic glass thermostatic bath CT72/P (230V) for temperatures +10 °C ... +60 °C	9, 39
ViscoClock <i>plus</i> M1, 115V	285417920	ViscoClock <i>plus</i> and acrylic glass thermostatic bath CT72/P (115V) for temperatures +10 °C ... +60 °C	9, 39
ViscoClock <i>plus</i> M2, 230V	285417930	ViscoClock <i>plus</i> and glass panelled thermostatic bath CT72/2 (230V) for temperatures -40 °C ... +150 °C	9, 39
ViscoClock <i>plus</i> M2, 115V	285417940	ViscoClock <i>plus</i> and glass panelled thermostatic bath CT72/2 (115V) for temperatures -40 °C ... +150 °C	9, 39
Thermostat vessel	285424400	Thermostat vessel ViscoClock <i>plus</i>	57

Technical Data - ViscoClock *plus*

Measuring range - Time	up to 999.99 s; resolution 0.01 s	
Accuracy of time measurement	±0.01 s/±1 digit; however no more precise than 0.1 %; indicated as measuring uncertainty with a confidence level of 95 %	
Measuring range - viscosity	0.35 to 10,000 mm ² /s (cSt) the absolute, kinematic viscosity is additionally dependent on the uncertainty of the numerical value of the viscometer constant and on the measuring conditions, in particular the measuring temperature.	
Display	LCD graphic display (FSTN) 128 x 64 pixel, 51x31mm (w x h) seconds indication with 2 decimal digits after the decimal point, resolution 0.01 s	
Voltage supply	DC + 9 V	
Power supply	in accordance to class of protection III degree of protection for dust and humidity IP 50 in accordance with DIN 40 050 Universal power supply TZ 1858: 100-240 V, 50-60 Hz (9 V, 550 mA) not suitable for use in areas subject to explosion hazards	
Interfaces	USB Host to connect USB flash drive or printer (TZ 3863) USB OTG to connect (PC), printer (TZ 3863) or USB flash drive	
Plug Connections	socket for low voltage connection: coaxial power connector, inner diameter 2.1 mm, plus pole at inner contact for connection of Universal power supply TZ 1858 Type A USB connector Type B mini USB connector	
Ambient Conditions	Ambient temperature	+10 to +40 °C for storage and transport Operating temperature stand: -40 to +150 °C electronic measuring unit: +10 to +40 °C
	Humidity	in accordance with EN 61 010, Part 1 max. relative humidity 80% for temperatures up to 31 °C, decreasing linearly to 50% of relative humidity at a temperature of 40 °C
Housing	Materials	stand: polyphthalamide (PPA) casing: polypropylene (PP) gaskets: silicone
	Dimensions	~515 x 90 x 30 mm (H x W x D)
	Weight	~450 g (without viscometer) power supply unit: ~220 g
Country of origin	Federal Republic of Germany	
CE symbol	In accordance with low voltage guideline 2014/35/EU Test regulation EN 61 010-1:2011-07 for laboratory instruments in accordance with EMC regulation 2014/30/EU Test regulation EN 61 326 Part1:2012 In accordance with RoHS regulation 2011/65/EU Test regulation EN 50 581:2013-02 FCC Symbol	
Viscometer types	Ubbelohde (DIN; ISO; ASTM; Micro), Micro-Ostwald, type SI Analytics®	
Transparent thermostatic baths	The ViscoClock <i>plus</i> can be used in all SI Analytics® bath types	

1.3 ViscoPump III

The ViscoPump exists currently in the 3rd generation. It is included in all AVS® devices and has several central functions:

- The signals of automatic meniscus detection - from measuring stands in the case of optical detection or TC viscometers - are evaluated to determine the flow time.
- With a built-in pump, the liquid is pneumatically pumped up into the measuring bulb of the viscometer.
- The available working modes are either the classic pressure or the suction mode. The operation (by suction of the liquid in the capillary tube) has advantages in some applications, in particular in automated measuring stations with a waste system.
- The built-in micro-processor controls the pumping process via several adjustable parameters.
- In the case of a connected waste system, the discharging by an external pump is also controlled by the ViscoPump III.



Ordering information

Type No.	Order No.	Description
VZ 8561	285424060	ViscoPump III for optical detection
VZ 8562	285424070	ViscoPump III for TC detection

The core of all AVS® systems

The measurement control by the ViscoPump is part of the modular device concept of AVS® systems:

- In multi-channel systems, one ViscoPump III controls the measurement at one measuring position.
- When servicing, a ViscoPump III can be easily replaced by the user.

Despite a new microcontroller, the new ViscoPump III is functionally compatible with its predecessors ViscoPump and ViscoPump II: Existing ViscoPump modules from older generations can be replaced by the new ViscoPump III. Also a mixed assembly in multi-channel systems, e.g. with ViscoPump II and ViscoPump III, is possible.

The ViscoPump III is available in two versions, for optical or TC detection.

The ViscoPump III is usually delivered in a package together with other components as a complete AVS® system, and only ordered separately in case of replacement or upgrade to additional measuring positions.

- ▶ Optimized command sequences of ViscoPump III compared to ViscoPump II
- ▶ Compatible to earlier versions
- ▶ Update possible via internal USB port
- ▶ Modular concept
- ▶ In case of service, the ViscoPump III can be easily replaced by the user.
- ▶ Pumping mode reversible, between suction and pressure mode
- ▶ Proven mechanical components (pump, valve) of high durability

Benefits
ViscoPump III

Measurement Devices



1.4 AVS® 470

Precise Capillary Viscometry – Easy, Flexible and Independent of a PC

- Perfectly equipped for automatic viscosity measurements

The AVS® 470 is a measuring system that includes everything you need to take precise and reproducible measurements. All types of viscosity calculations with polymer solutions are integrated into the device. A small keyboard allows you to enter additional data. A serial printer can be used to conveniently document your results.

So, in a minimum of space, you can set up a measuring station equal in every way to complex measuring installations in terms of precision and reproducibility.

- Simple and updateable Modular Concept

The AVS® 470 is equipped with a ViscoPump III and therefore limited to one measuring station.

Due to its modular design, the AVS® 470 can be used with a ViscoPump III, either for optical or TC detection.

You can use your existing accessories such as thermostats, stands or flow-through coolers. Also, virtually all SI Analytics® capillary viscometers can be used.



Measurement Devices

Preferred "Suction" or "Pressure"?
Applications in comparison

	"Pressure"	"Suction"
highly viscous samples e.g. oils, polymers	■	■
Solvents: highly volatile (examples)	■	-
Dichloromethane	■	-
Chloroform	■	-
Sulfuric acid	-	■
Dichloroacetic acid	-	■
Toluene	■	■
Hexafluoro-isopropanol	■	■
m-cresol	-	■
Formic acid	-	■
Phenol / dichlorobenzene	-	■
Phenol / Tetrachloroethane	-	■
Without waste system	■	-
With waste system	-	■

- Automatic and highly precise measurements - independent of a PC
- "Suction" and "pressure" measurements with the same system
- Simple data input and parameterization via included mini-keyboard
- GLP documentation compliant when connected to an optional printer

Advantages
AVS® 470

AVS® 470 - Precise and Reliable

Working with the AVS® 470 is easy

The desired measurement method can be preselected and started on the device. The entire measurement is automatic to eliminate subjective measurement errors. Once the set pre-heating time is reached, the desired number of measurements are taken. The status of the measurements is continuously displayed.

If required, individual parameters may be input via an included keyboard. A serial printer can be used to print measurement logs.

The connections are on the front panel of the device for easy control. Over-pumping and oversuction are prevented by the use of an optional capacitive sensor.

The print-out shows everything you need for reliable documentation of your test.



```

No. 1 = 77.20s
No. 2 = 77.21s
No. 3 = 77.20s

=====

*****
*                               *
*  ViscoSystem AUS470          *
*    protocol                   *
*                               *
*****

method : absolute

Id : 11
lot: SIM Test sample
usr: A. Eich

measurements [s]
No. 1 = 77.20*
No. 2 = 77.21*
No. 3 = 77.20*

delta%choice = 0.01%
pre temp. time = 0min

average      = 77.203s
stand. dev. = 0.006

constant = 0.029999996

AbsVisc=2.3161mm^2/s

temperature: 25.00 C
date:      05/12/2017
time:     09h 47m 27s
    
```

Individually determined readings

Indication of method set

Designation of specimen

Readings used for evaluation

Set equalization time

Corrected average running time

Calculated Viscosity

Charge Number

User

Set maximum permissible deviation from average

Average of running times

Viscosimeter constant

Operating temperature, date and time at time of test

Clear user guidance, clear status - even without PC!

```

ViscoSystem AUS470
ViscoPump Check
system check: OK
Press Enter
    
```

After switching on the AVS® 470 a self test is run and then an entry prompt appears.

```

create method
mode: absolute
      Sayboldt
      relative
      blank value
    
```

The parameters can be set in the test mode. In case of a required blank value, it is saved in the system.

```

ViscoPump Parameter
suction / Pressure
OFF      0.10
ramp:    15 %
PUMP Power: 0.35 %
meas. delay: 1.0 f
time above N1: 1.0 f
    
```

All setup parameters can be preset conveniently, e.g. pressure/suction, pumping speed, waiting time between two tests, etc.

```

result corr.
average      = 36.975s
stand. dev. = 0.092
correction = 0.000s
corr. ave.  = 36.975s
AbsVisc= 3.6605mm^2/s
    
```

The readings can be read off conveniently on the display regardless of whether or not a printer is connected.

Technical data

Measuring range (time)	5 s up to 9,999.99 s; resolution 0.01 s	
Measuring range (viscosity)	pressure:	0.35 to 1,800 mm ² /s (cSt)
	suction:	0.35 to ~5,000 mm ² /s (cSt)
Measured parameter	flow-through time [s]	
Time measuring accuracy	± 0.01 %	
Measured value display	LC-Display	
Display accuracy	± 0.01 s, ± 1 Digit, but not exceeding 0.1%	
Pumping pressure	fully automatically controlled	
	suction up to ~-160 mbar, pressure up to ~+160 mbar	
Preselectable tempering period	0 to 20 min	
Connections	Pneumatic connections	threaded connections for viscometers
	Electrical connections	circular connector with bayonet lock for viscometer 4-pin DIN socket for TC viscometer 4-pin circular connector for capacitive sensor 7-pin circular connector for AVS® 26, with bayonet lock RS232-C interface 9-pin for serial printer
Ambient Conditions	Mains connection	connector in acc. with EN 60320
	Pump connection	socket outlet in accordance with EN 60320
Housing	Ambient temperature	+10 to +40 °C for operation and storage
	Air humidity	max. 80 % in acc. with EN 61010, Part 1
Power supply	Material	steel aluminium housing with chemically resistant 2-component coating
	Dimensions	(W x H x D) ~255 x 205 x 320 mm
Equipment safety	Weight (incl. ViscoPump module)	~5.4 kg
		90 to 240 V ~, 50 to 60 Hz
	EMC in acc. with Council Directive 89/336/EWG; low-voltage directive	

Ordering information AVS® 470

The AVS® 470 viscosity test station is composed of individual components. Please request a detailed quote..

Type no.	Order no.	Description
AVS® 470 basic unit for opto-electronic sensing	285415709	AVS® 470 basic unit, housing incl. one ViscoPump III module for opto-electronic detection, keyboard Version: 95 V to 230 V/50-60 Hz
AVS® 470 basic unit for TC sensing	285415708	AVS® 470 basic unit, housing incl. one ViscoPump III module for TC detection, keyboard Version: 95 V bis 230 V/50-60 Hz
VZ 8561	285424060	ViscoPump III module for optical detection
VZ 8562	285424070	ViscoPump III module for TC detection
Z 910	285225640	RS232-C data printer

The AVS® 470 allows the use of the following SI Analytics®-viscometers: Ubbelohde viscometer to DIN, Ubbelohde viscometer to ASTM, micro Ubbelohde viscometer to DIN, micro Ostwald viscometer, Cannon-Fenske routine viscometer, TC Ubbelohde viscometer, TC micro Ubbelohde viscometer.

We reserve the right to make technical changes.

AVS® is a registered trademark of SI Analytics® and stands for: "Automatic Viscosity System".

1.5 AVS® 370

AVS® 370 makes maximum precision ...

Well equipped for all viscosity determination

The AVS® 370 is a PC-controlled measuring device, which not only measures as precisely and consistently as you expect, but also offers maximum flexibility and future extensions. Furthermore, it saves laboratory space.

▲ Suction and pressure mode - with one device

The AVS® 370 is operating with the ViscoPump III as the control unit for measurement and rinsing and therefore is able to pump the sample liquid in two different ways: by "suction" as well as by "pressure".

This makes it possible to simple adapt the method of measurement to different samples and applications: E.g. for non-critical samples as pharmaceutical solutions, we recommend to use the classic pressure mode. In pressure mode, at first the viscometer is filled and afterwards the filling and venting tube of

... easier and more flexible, with provision for future expansion!

the viscometer are connected to the ViscoPump. By applying pressure, the liquid is pumped to the measuring bulb.

The pressure mode is recommended for high-volatile solvents, as evaporation is lower compared to solvent mode. The viscometers have to be discharged and cleaned manually.

In suction mode, the sample liquid is pumped by vacuum up through the capillary. One main advantage is, that liquid can not leave the system. Therefore this method is often applied for hazardous samples.

For such samples, e.g. in polymer analytics, it is often requested to reduce liquid handling as much as possible, and therefore also the manual cleaning of viscometers. For these applications we recommend a waste system, combined with the AVS® 370, which makes manual discharge and cleaning of viscometers obsolete.

When combined with a waste system, the AVS® 370 exclusively is working in suction mode: due to increased safety, and the fact that in suction mode the filling tube of viscometer keeps open, which is required for sample filling.



- ▲ Automatic and highly precise measurements
- ▲ "Suction" and "pressure" measurements with the same module
- ▲ Modular concept for up to four ViscoPump III modules in one AVS® 370
- ▲ Each ViscoPump III module in a AVS® 370 can measure a different sample using a different method.
- ▲ Real multitasking for up to eight parallel measurements with the software Win-Visco 4
- ▲ TC version for measurement of nontransparent and black liquids

Advantages
AVS® 370

As a further advantage, the suction mode exhibits increased reproducibility of flow times in case of Ubbelohde viscometers and samples which tend towards foaming: The bubbles are created during pumping of the liquid to the measuring bulb, when air is mixed with the small amount of liquid remaining in the lowest part of the capillary. In suction mode, the liquid can be blown out by a special function of software WinVisco 4.

Two detection methods to measure flow times

To measure the flow time, the liquid meniscus can be detected by optoelectronics or thermally, by TC sensors. In both cases, the flow time is displayed with a resolution of 0.01 s.

Using optoelectronic detection, the liquid meniscus is registered by using IR light barriers; for detection with TC sensors, the different thermal conductivity of air and sample is utilized. With these options, the AVS370 covers a broad range of applications, including transparent and opaque samples as well.

Easy modular concept ideal for future expansion

The AVS® 370 has a modular design. The basic version is available with one ViscoPump III module in optical or in TC version. Up to 3 other ViscoPump III modules can be installed in the compact housing. The measuring station can be adapted to increasing requirements at any time.

Can be expanded from an affordable single measuring station up to an 8-sample station

The basic version of the AVS® 370 is able to measure the viscosity of liquids automatically. The TC version viscometers, it is ideal for measuring opaque and

black fluids. If necessary, each single measuring station can be expanded to a multiple measuring station with up to eight measuring positions. The WinVisco 470 software included with the standard equipment enables parallel operation of two fully equipped AVS® 370, with a total of eight ViscoPump III modules. Each module can measure a different sample using its own method. All the results can be quickly and easily evaluated and documented independently. It could hardly be more flexible!

Waste system and rinsing

As mentioned above for the suction mode operation, the AVS® 370 can be combined with a waste system.

When using a waste system, after measurement the sample is discharged from the viscometer into a waste bottle - the viscometer is rinsed while keeping installed. The manual cleaning of the viscometer becomes obsolete, and the effort for dis- and reassembling to the measuring stand as well.

For 1 and 2 measuring positions, we offer the AVS®370 as a package, containing all components including measuring stands, thermostat bath, recirculating cooler, safety sensors, filling and waste system with discharge pump, complete hose sets and PC software.

Compatible with existing accessories

Possibly existing accessories (thermostats, stands, flow through cooler, etc. von Vorgängermodellen) can continue to be used with the AVS® 370. Also, virtually all customary SI Analytics®-capillary viscometers can be used.



AVS® 370 – the right solution for all situations

Working with AVS® 370 is easy

The entire measurement procedure is place automatic, subjective measuring errors are reliably eliminated. The PC starts the measurement. After the set preconditioning period the selected number of Durchflusszeiten gemessen and the measured values saved.

The system protects against accidental overpumping or oversuction by means of a capacitive sensor.

This prevents the sample to be measured from getting into the vessel containing the liquid or inside the device.

Unique flexibility

In the PC-controlled multiple measurement station, the AVS® 370 offers unique flexibility while working in a very small space: Up to eight ViscoPump-modules, which equates to two fully equipped AVS® 370, can be run in parallel with the WinVisco 470 software.

Each module can measure the same or different samples using "pressure" or "suction", independent of each other. This significantly reduces the time required to carry out viscosity measurements im Parallelbetrieb, especially for in process controls and quality assurance. In this way, a series of measurements can be prepared quickly and immediately evaluated and documented with the computer.



Technical data

Measuring range (time)	up to 9,999.99 s; resolution 0.01 s	
Measuring range (viscosity)	pressure:	0.35 to 1,800 mm ² /s (cSt)
	suction:	0.35 to ~5,000 mm ² /s (cSt)
Measured parameter	flow through time [s]	
Accuracy of the time measurement	± 0.01 %	
Measured value display	via PC	
Display accuracy	± 1 digit (0.1%)	
Pump pressure	automatically controlled	
Preselectable tempering period	0 to 20 min	
Preselectable number of measurements	up to 10	
Connections	Pneumatic connections	threaded connections for viscometers
	Electrical connections	circular connector with bayonet lock for measuring stands and TC viscometers
	RS232-C interface	9-pin
	Mains connections	plug in accordance with EN 60320
	Pump connection	socket outlet in accordance with EN 60320
Data Input/Output	serial to EIA RS232-C	
Ambient conditions	Ambient temperature	+ 10 to + 40 °C
	Air humidity	max. 85% rel.
Housing	Material	coated aluminum plate
	Dimensions (for 1 to 4 modules)	(W x H x D) ~255 x 205 x 320 mm
	Weight (incl. 1 module)	~5.4 kg
Power supply	90 to 240 V ~, 50 to 60 Hz	
Equipment safety	EMC-Compatibility according to the Directive 89/336/EEC of the Council	
	low-voltage directive according to the Directive 73/23/EEC of the Council as amended by the Directive 93/68/EEC of the Council	
Multi-tasking	for 1 to 8 ViscoPump III modules, with WinVisco 4 software	

Ordering information AVS® 370

The AVS® 370 viscosity test station is composed of individual components. Please request a detailed quote.

Typ-Nr.	Bestell-Nr.	Beschreibung
AVS® 370 basic unit for opto-electronic detection	1056509	AVS® 370 basic unit, housing incl. one ViscoPump III-Moduls and Software WinVisco 370 software, for opto-electronic sensing
AVS® 370 basic unit for TC detection	1056515	AVS® 370 basic unit, housing incl. one ViscoPump III-Moduls and Software WinVisco 370 software, for TC sensing

Accessories for AVS 370® and AVS 470® you can find at page 49 and following.

The following viscometers can be used with the AVS® 370:
Ubbelohde viscometer to DIN, Ubbelohde viscometer to ASTM, micro Ubbelohde viscometer to DIN, micro Ostwald viscometer, Cannon-Fenske routine viscometer, TC-Ubbelohde viscometer, TC-micro Ubbelohde viscometer.

We reserve the right to make technical changes.
AVS® is a registered trademark of SI Analytics and stands for: "Automatic Viscosity System".

1.6 Software WinVisco 4

Software WinVisco 4 ...



Clearly separated: work area, main menu, menu bar and header



Individual Layout

The new WinVisco 4 is the ideal software to control the AVS®370, and it is included in the basic configuration of the instrument. Up to 8 viscometry measuring units (ViscoPumps) can be controlled by only few operating steps.

The WinVisco 4 is newly programmed - on the one hand combining clear representation of results, while on the other hand a comprehensive and detailed configuration of settings for the measuring method is possible.

As the previous version, the software is working in real multi-tasking operation, as WinVisco 4 is cooperating with the ViscoPumps, whose internal software is controlling the time measurement and the measuring sequences.

Individual configuration of user interface

- Multi-Language: English, German, French, Spanish, Chinese
- Changeable Layout, e.g. graphics in white/black or black/silver.

..the new control software for AVS®370

Simple operation

The daily measuring routine is carried out in a simple manner, using two windows: "Start" and "Overview"

Temperature monitoring

New: With WinVisco 4, the bath temperature can be monitored when using a thermostat of the CT52 and CT72 series.

Clearly arranged

The requested results, e.g. the kinematic viscosity or viscosity number, can be shown in the overview.

User management

The WinVisco 4 supports three different user types of users. In the lowest level, user, only operation is allowed. It includes the execution of measurements, but also the selection of methods and viscometers. In addition, the lab manager can change all settings: Configuration of the measuring position and method as well as the viscometer database.

The administrator additionally can manage the user access data.

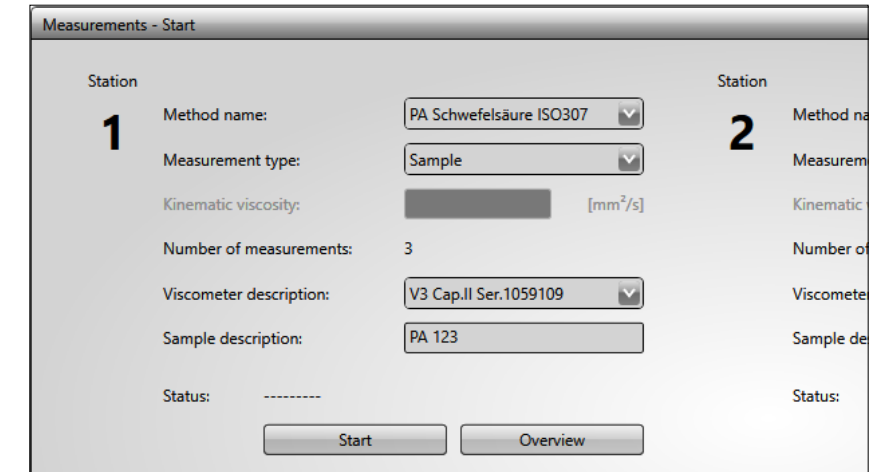

Sample input in window "Start"



Everything under control

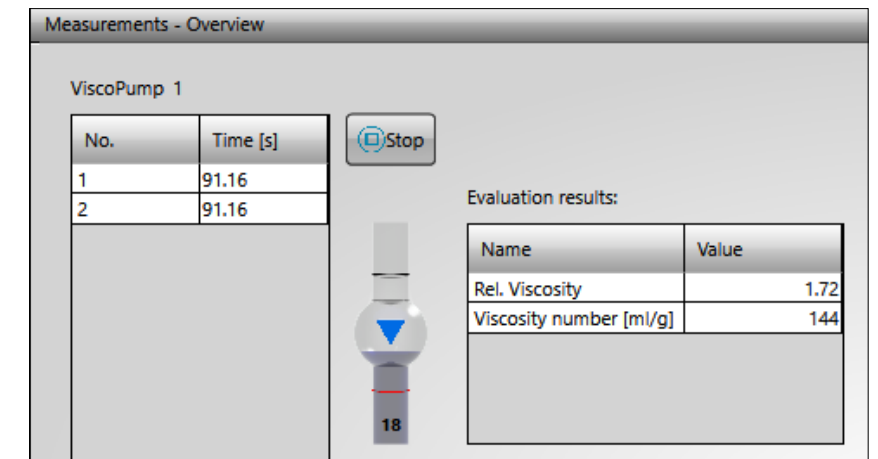

Overview of current measurements

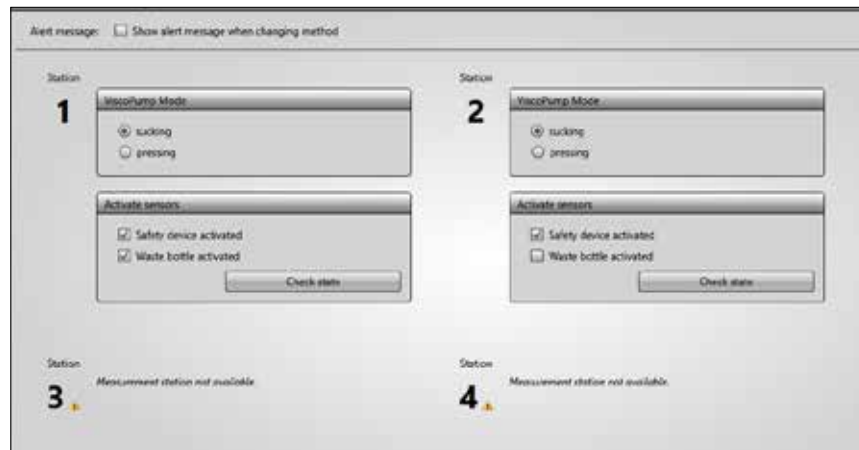

Configuration

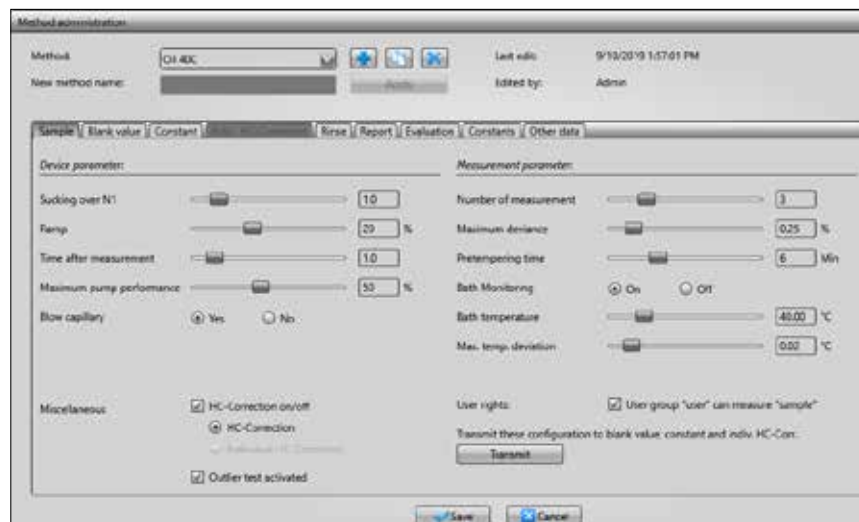

Method management

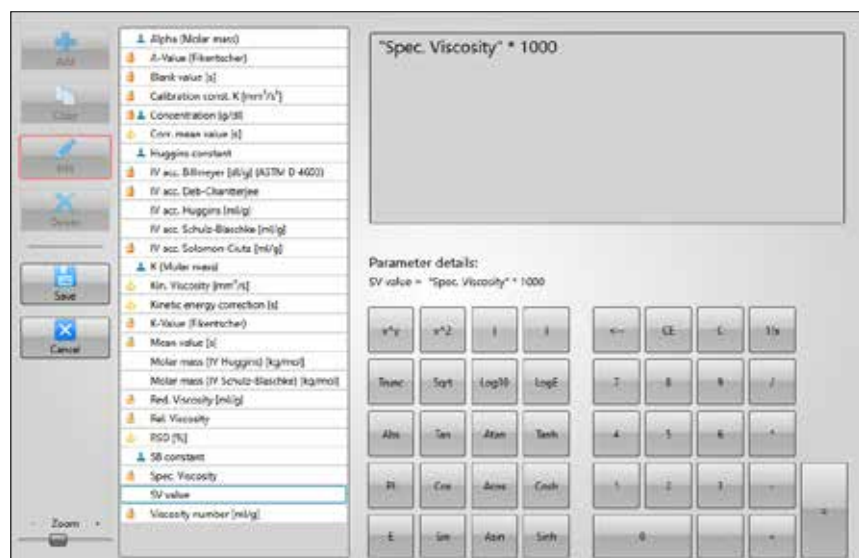

User-defined formula

Configuration of measurement station

For individual configuration of single measuring positions, e.g. "suction" or "pressure" mode, or activation of safety sensors.

Method

All measurement settings which valid for all positions are done in the method, e.g. parameters of the ViscoPump III and the measurement, the evaluation and the configuration of an optional rinsing sequence.

Rinsing

To rinse, there are two possibilities: rinsing with sample and rinsing with solvent. In both cases, the AVS® 370 is connected to a waste system, to enable rinsing of the viscometers keeping installed: With a build-in vacuum pump, samples and rinsing solvent are sucked into a waste bottle - the disassembling of viscometers for cleaning becomes obsolete.

- ▶ Simple handling in routing operation
- ▶ Individually configurable
- ▶ Multi-Language
- ▶ Monitoring the bath temperature with thermostat CT72
- ▶ Control up to eight measuring positions

Benefits
WinVisco 4

The rinsing with sample is especially used in case of some polymer applications. Alternatively, rinsing with up to two solvents for each measuring position is possible.

In case of solvent rinsing, a daisy chain connection enables the integration and control of additional burettes Titronic® 300 (or Titronic® 500) to the AVS® 370.

- ▶ The sequences for rinsing are individually configured in the software.

Evaluation

For evaluation, the WinVisco 4 includes many predefined formulas at state of delivery.

Additional calculations can be defined using a formel editor.

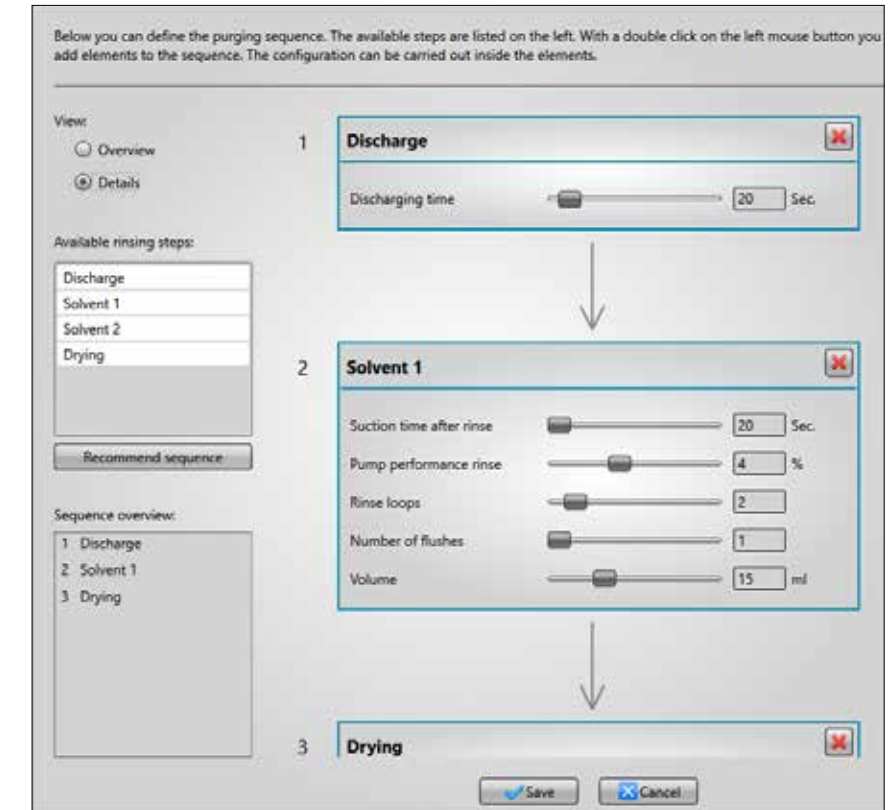

Clearly structured: Rinsing sequence

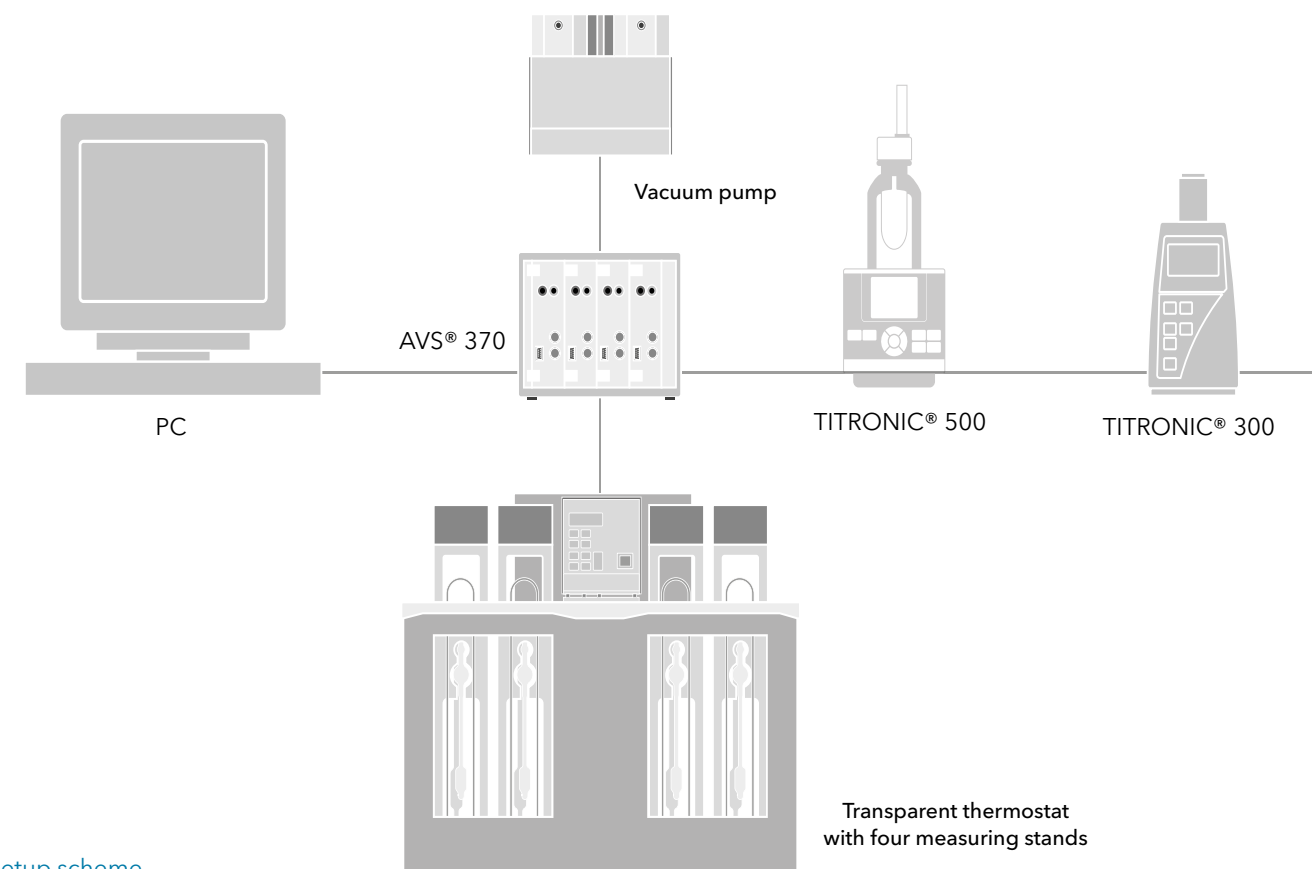

Setup scheme

1.7 AVS® Pro III

Automatic viscosity measurement has been improved ...

The AVS® Pro III automatic sampler is a fully automated instrument for determining the viscosity of Newtonian fluids using capillary viscometers. The system is mainly used for polymer analytics, e.g. according to ISO 307, ISO 1628 or ASTM D4603. But it also complies to the requirements of absolute measurements according to DIN 53 000, ASTM D445/D446 and ISO 3104/3105. In spite of the high sample throughput, the AVS® Pro III provides maximum accuracy and reproducibility. Furthermore, working with the automatic sampler is easy and allows unattended 24-hour operation.

In comparison to AVS® 370, at AVS® Pro III also the filling of the viscometer is automated. Therefore the complete measuring sequence - filling, measuring, discharging and rinsing - is fully automated, to enable unattended operation. The filling is done by a dosing module (piston/cylinder) in a 3-axis robotic system:

The samples are sucked by a sample needle from a sample bottle and transferred to the viscometer. Due to medium hose lines of only minimum length, any carryover can be kept low easily.

Particularly for high sample throughput, the AVS® Pro III helps to substantially reduce the burden on qualified users. The fully automatic mode offers an increased level of safety when handling aggressive media, e.g. sulphuric acid.

Applications

For the concept of AVS® Pro III, particularly the requirements of polymer quality control have been incorporated, e.g. for measurement of intrinsic viscosity, viscosity number, K value, or similar measures. But also the measurement of petrochemical products is possible.

Different configurations

The AVS® Pro III typically is equipped with 2 to 4 measuring positions, to achieve higher sample throughput when measuring in parallel.

The following viscometer types can be used: Ubbelohde (DIN, ASTM), Mikro-Ubbelohde (DIN), Cannon-Fenske routine and Micro-Ostwald of SI Analytics®.

The standard waste system contains a waste bottle for each measuring position. The advantage: This system is very reliable in operation, as it does not need valves being in contact to the medium. But as a special configuration, also a waste system with only one waste bottle is available.

... with the AVS® Pro III Automatic Sampler

Safety and reliability

The AVS® Pro III has an outstanding reliability: The dosing system (available as standard and Micro version) is operating without valve and therefore is suitable for nearly all samples. Due to further development of hardware components and software, the system has been continuously improved, resulting in a minimization of error sources. E.g., in the robotic system, non-contact switches are in use. And the system abstains from medium-conveying valves, if not required for special customer applications. Even

more important than reliability is the safety for the user. For this, the liquid in the waste system is transferred only by low instead of high pressure: Therefore, the liquid is only aspirated to the waste bottle, not pressed. In case of leakage, only air can enter into the system, but never liquid leave the system.

Regarding safety devices, there are capacitive sensors to control the suction line between viscometer and control unit, as well as liquid level detection of the waste bottles. In case of a signal of these safety devices, the corresponding measuring position is switched off.

- ▶ Fully automatic and highly precise measuring station. Time measurement with a precision of +/- 0.01 s (but less precise than 0.1%)
- ▶ Ideal for highly aggressive media
- ▶ Although in combination of optical and thermal sampling of the meniscus channel or different capillary sizes and types, up to four viscometers selectable
- ▶ Durch die optionale Filtration mit dem ProClean system eliminate manual filtration of the sample
- ▶ Individually configurable, e.g. for rinsing with sample or solvent, or use of different viscometer types.

Advantages
AVS® Pro III



Rinsing: Either with sample or with solvent

The rinsing of dosing module and viscometer is carried out according to the application and customer's preferences. Both alternatives have benefits and drawbacks.

Most AVS® III systems are configured for rinsing with next sample. For this, in total 3 fillings of viscometer are required: Using the first 2 charges, the dosing module and the viscometer are rinsed, and only the 3rd filling is used for measurement.

As Ubbelohde viscometers of standard size require a liquid volume of about 17 ml, the total sample volume needed is about 60 ml.

Therefore typically sample bottles of 100 ml volume are used. We recommend this configuration for applications in polymer analytics, when supply and disposal of the sample solvent is cheap and rinsing with external solvent exhibits drawbacks. An important application is the measurement of polyamide in sulfuric acid (96%) according to ISO 307.

When using expensive and hazardous solvents, e.g. for measurement of polyesters according to ISO 1628-5 or ASTM D4603, often the user wants to use only a small amount of sample. In this case it is possible to use micro viscometers with filling volume of max. 4 ml - in this case a sample volume of 20 ml is sufficient for rinsing and measurement. In case of micro viscometers, the AVS® Pro III is equipped with a special dosing module for small sample volumes.

Alternatively, instead changing to viscometers with smaller sample volume, there is the option of rinsing with external solvent - then only one filling of viscometer is required. In this way, also for standard Ubbelohde viscometers a total sample volume of 25 ml is sufficient. Using solvent rinsing, dosing module and viscometer are rinsed 2 times with solvent. Preferably, this solvent is volatile, to enable a drying step directly afterwards. Otherwise, subsequent a second solvent with low boiling point has to be used, but this does not need to be a solvent for original sample. During drying the remaining residues of

solvent are evaporated by applying vacuum respective in a stream of air, therefore afterwards the next sample can be filled in.

When rinsing with sample, not only some reagent for sample preparation is saved: due to smaller sample bottles, sample racks with 56 instead of 16 positions can be used.

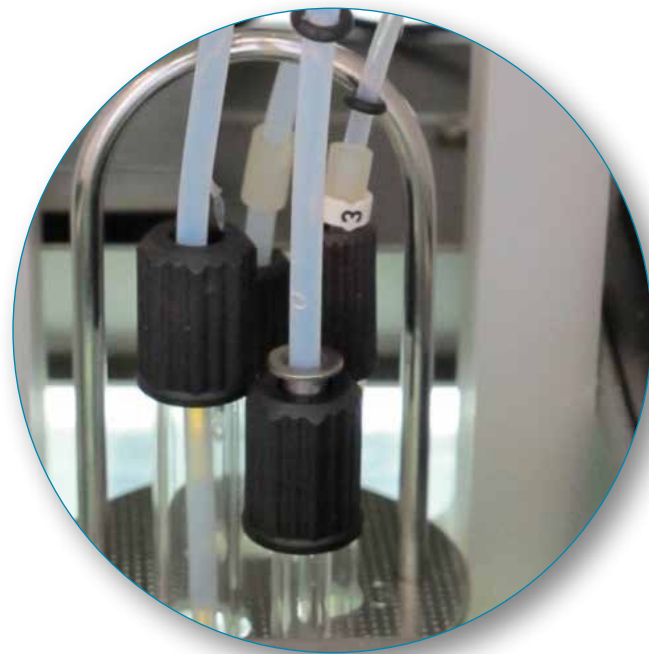

4-tube viscometer, for rinsing with solvent

As a special option it is also possible, to insert an additional rinsing sequence at the end of a measuring series.

Sample rack

There are several sample racks available, depending on the size of the sample bottles. For 100 ml bottles a sample rack with 16 positions is used. For 40 ml bottles and 20 ml vials, there is a sample rack with 56 positions available. The samples are positioned in the sample rack, which is easy to load due to an electric sample lift. The AVS® Pro III allows free selection of sample sequence and moreover individual allocation of samples to certain viscometers.



Two different sample racks are supplied:
a) rack with 56 positions for 20 ml and 40 ml (new) sample bottles.



b) Rack with 16 positions for 100ml sample bottles and viscometer with standard sample volume and rinsing with sample

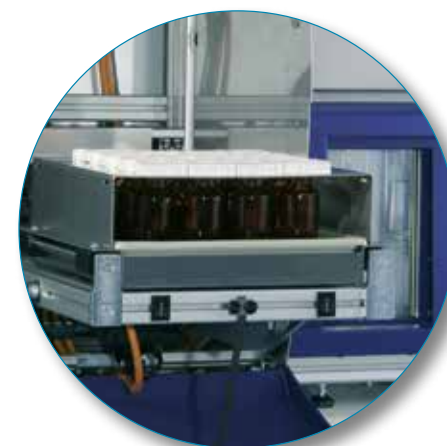

The electric sample lift ensures positioning of the samples in the rack at a convenient and easily monitored working height.

Filtration

As long as particle-free liquids are measured, there is no filtration necessary. In case of only occasional particles, inline filters can be integrated into the filling hoses, to avoid any issues by impurities entering the viscometer. But in case of measuring e.g. glass fiber reinforced polymer samples, inline filter can't be used - they would be blocked within short time of use. For such samples there is the ProClean filtration system available, which is already filtering the sample in the sample bottle.

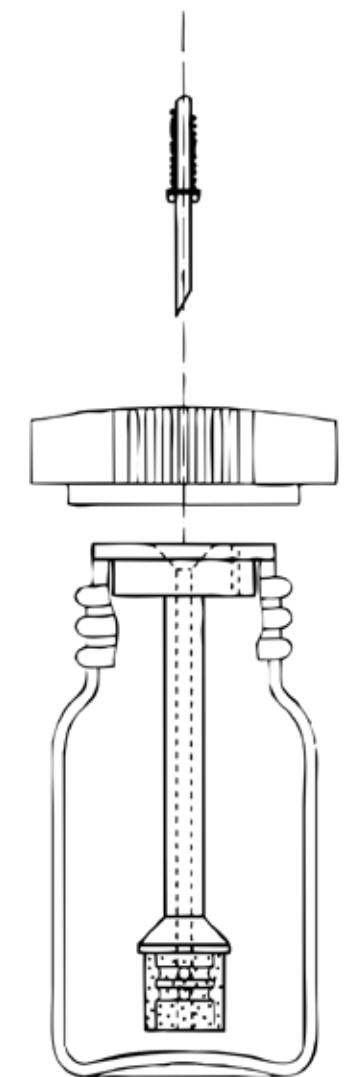

Filtration system ProClean

Working with the AVS® Pro III is ...

The AVS® Pro III is controlled by a PC. The intuitive user interface guides the user clearly through the program. All data inputs are made using the computer keyboard and mouse.

A faulty operating status is indicated by acoustic or optical signals such as arrows, icons and other status messages or request messages. During the entire work sequence, the respective status of the AVS® Pro III is documented on the computer screen. Furthermore, status indicators can be selected for each individual measuring position, which provide additional information on operation.

For the respective type of measurement, pre-parameterized sets of parameters depending on the viscometers, temperature and other measurement criteria are already provided. In addition, all parameters can be individually adjusted to special requirements at a special menu level. All of the standard calculation methods are available:

- mean value
- standard deviation
- outlier test (A %)
- Hagenbach correction
- absolute viscosity, dynamic viscosity (density value required)
- viscosity index (measurement at two temperatures required)
- SUS and SFS
- relative viscosity
- specific viscosity
- reduced viscosity (viscosity number)
- inherent viscosity
- intrinsic viscosity and
- K-value after Fikentscher

The proved and tested AVS® Pro III software also makes it possible to prepare additional individually selected calculations:

During the entire process, all of the parameters (depending on the menu level) and the respective status of the individual measuring positions, the temperature regulation system and the sample transfer system are either visible or can be selected.

The operator interface of the AVS® Pro III is available in German and English. Commercially available

printers for which Windows drivers are available are suitable for documentation purposes.

The AVS® Pro III is built in accordance with international equipment safety standards: and CE certified (equipment safety, low voltage safety, emitted interference and interference immunity).

If requested, the AVS® Pro III automatic sampler can be supplied with a manufacturer's inspection certificate based on direct comparison with normal viscometers of the first order in accordance with DIN 53 000-3.

Software

Some features of the software are described in the following.

Individual sample allocation

The AVS® Pro III allows individual allocation between the characteristics of the sample and the viscometers that are currently in operation.

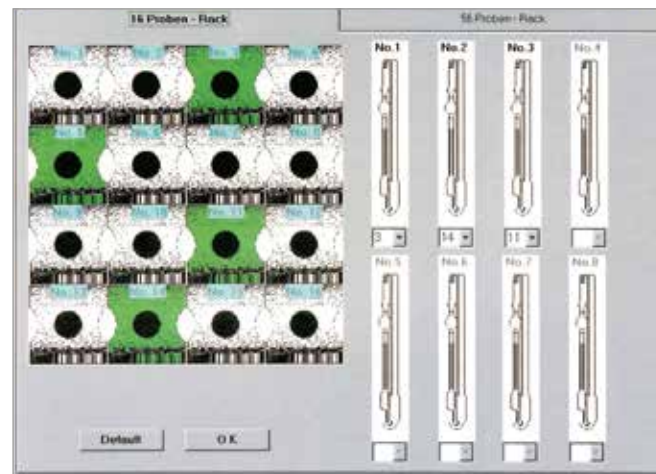

The allocation between the sample and the viscometer is shown on the status display.

In practice, samples of different viscosities can be filled into viscometers of different size and measured at the same time. This even applies to a combination of optical and thermal scanning. Therefore, preliminary sorting of the samples with regard to viscosity and the size of capillary required for the testing process is not necessary.

... easy, reliable and safe

Method

This mode is used to specify what monitoring parameters are to be activated, e.g. if the temperature control of the thermostats is supposed to be handled via the PC.

Options

In several windows, configuration details are parameterized: e.g. size of dosing module, immersion depth of the sample needle, volumes of rinsing solvent, activation of safety devices and temperature control of bath thermostat, but also change of language English/German etc.



Selection of method

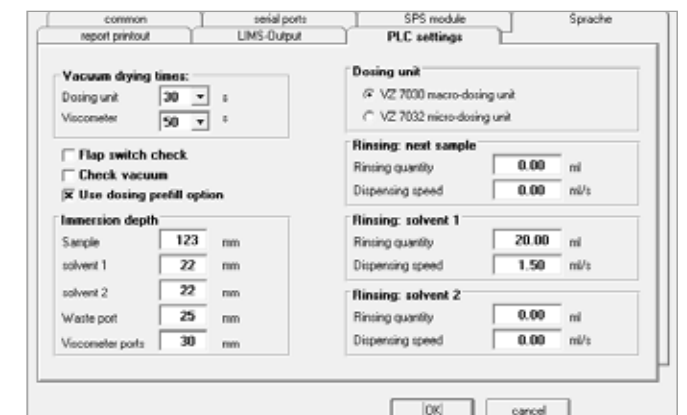

Options



Technical data AVS® Pro III

Sampling system	Sample bottles	100 ml screw-type and bottles with standard ground joint (16 pcs per rack)	
		20 ml round bottom glass pieces (56 pcs. per rack)	
		40 ml EPA-Screw-thread bottle (16 or 56 pcs. per rack)	
Sample rack		for 100 ml screw-type and bottles with standard ground joint	
		for 20 ml round bottom glass pieces	
		for 40 ml EPA-Screw-thread bottle (16 or 56 pcs. per rack)	
Measured value recording	Method	meniscus scanning by means of opto-electronic system or thermal conductivity (TC)	
Measuring parameter		throughput time in seconds [s]	
		temperature in degrees Celsius [°C]	
Calculated parameters		mean value, standard deviation, outlier test (A %), Hagenbach correction, absolute viscosity, dynamic viscosity (knowledge of density required), viscosity index (measurement at two temperatures required) SUS and SFS, relative viscosity, specific viscosity, reduced viscosity (viscosity number), inherent viscosity, K-value, intrinsic viscosity	
Selection parameters		by means of PC keyboard, mean value, standard deviation, outlier test (A %), Hagenbach correction, absolute viscosity, dynamic viscosity (knowledge of density required), viscosity index (measurement at two temperatures required) SUS and SFS, relative viscosity, specific viscosity, reduced viscosity (viscosity number), inherent viscosity, K-value, rack position, date/time, temperature regulation period, number of measurements, number of rinsing operations, start, stop/reset	
	Number of measurements	1 to 99	
	Temperature regulation period	0 to 99 min., selectable in increments of 1 min.	
	Number of Viscometer tests	0 to 10 with next sample (observe sample quantity) or with externem Spül-Lösemittel	
	Data memory	by means of PC	
Viscosity measurement range		0.35 to 1,200 mm ² /s (at room temperature of samples)	
	Time	up to 9999.99 s, resolution = 0.01 s	
	Vacuum pressure	automatically controlled	
	Viscometers available for use		Ubbelohde viscometer in accordance with DIN standards
			Ubbelohde viscometer in accordance with ASTM standards
			Micro-Ubbelohde viscometer in accordance with DIN standards
			Micro-Ostwald viscometer Cannon-Fenske-Routine visco
		Cannon-Fenske-Routine viscometer	
	TC Ubbelohde viscometer		
	TC Micro-Ubbelohde viscometer		

Measuring accuracy		±0.01 s ± 1 digit, but not more precise than 0.01 %
		The measuring uncertainty for measurements of absolute kinematic viscosity is also dependent on the uncertainty of the numeric value for the viscometer constant and on the measuring conditions, especially the measuring temperature.
Evaluations / results	Correction	Hagenbach correction (HC) for Ubbelohde, Cannon-Fenske-Routine, Micro-Ubbelohde and Micro-Ostwald viscometers
	Statistical evaluation	standard deviation, outlier search
Ambient conditions	Ambient temperature	10 to +40 °C
	Air humidity	max. 85 % relative humidity
Equipment safety	CE-symbol	in accordance with Guideline 89/336/EEC of the Council (EMC compatibility)
		in accordance with Standard EN 50 081, Part 1
		interference immunity in accordance with Standard EN 50 082, Part 2
		in accordance with Guideline 73/23/EEC of the Council (low-voltage guideline)
Housing		plastic/stainless steel / aluminium casing with chemically resistant two-component coating of the plastic pieces
	Dimensions	w = 1.300 mm, h = 1.000 mm, d = 620 mm (~51" x 43" x 24")
	Weight	dependent on the number of measuring positions ~70 kg
Connections	Pneumatic connections	screw-type connections for viscometer
	Electric connections	circular connectors with bayonet lock for measuring stand and TC viscometer
	Viscometers	up to 8 viscometers connected by individual control units
	Temperature	via serial interface RS232-C of suspended thermostat type: 1 pc. CT 72/4 or up to 2 pcs. CT 72/2, 1 pc. CT 72/2
	Interfaces	control system using PC with 2 x RS232-C interfaces bzw. USB/RS232-Adapter
	Safety	overflowing safety device of waste bottle and suction hose
	Mains connection	European built-in plug DIN 49 457 6 with fuse
Data transmission	Interface internal	bidirectional serial interface in accordance with EIA RS232-C (daisy chain concept)
	Interface external	via PC, bidirectional serial interface in accordance with EIA RS232-C
Power supply	Mains voltage	230 V (AC) or 115 V (AC), 50 to 60 Hz (AC)

1.8 CT 72 Thermostat Series



CT 72/4



CT 72/2



Bright display shows ongoing process, at any time.

Measurement Devices

- ▶ CT 72/2 and CT 72/4 can be used up to 150 °C. High temperature version is standard.
- ▶ Draining valve comes with CT 72/2, CT 72/2-TT and CT 72/4.
- ▶ High temperature stability ± 0.02 K as requested in viscometry standards

Advantages
Baths

As their predecessor CT 52 the transparent thermostats CT 72/P, CT 72/2, CT 72/2-TT and CT 72/4 meet DIN 53 000 part 1, ASTM D 445 and ISO 3105 standards.

The SI Analytics® transparent thermostats are particularly designed for the determination of the viscosity of newtonian liquids in glass capillary viscometers. They may be adapted for manual as well as for automatic measurements.

- ▶ Programmable set temperatures through integrated clock with controller.
- ▶ Display of the momentary and the set temperature.
- ▶ Increased safety from separate operation and temperature safety sensors.
- ▶ Automatic fuses on the back panel.

New
Immersion
thermostats

Transparent Thermostats conforming to Standards: The CT 72 series



CT 72/P

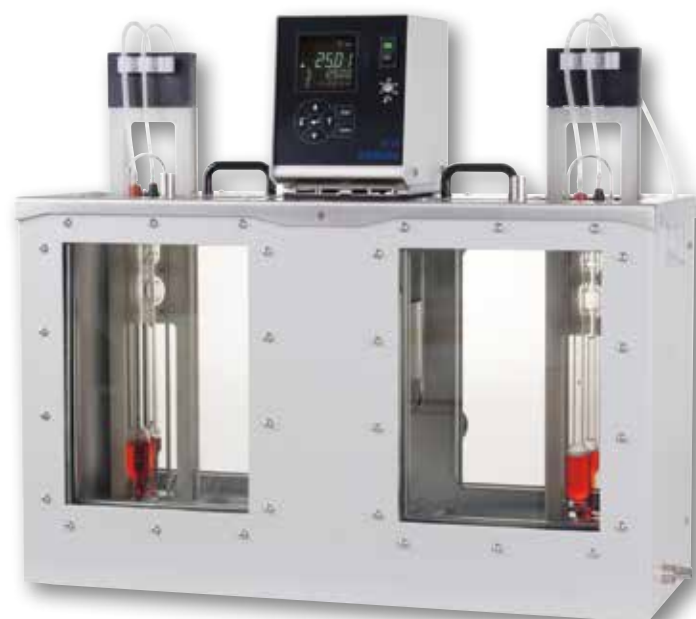

CT 72/4

Suitable temperature control liquids

Liquid	Alcohol	Water	Paraffine oil	Silicon oil
Temperature range	-40 °C to +10 °C	+5 °C to +80 °C	+40 °C to +150 °C	+80 °C to +150 °C

Technical data

Device	CT 72/P	CT 72/2-TT	CT 72/2	CT 72/4
Working temperature	+10 °C to +60 °C	-40 °C to +150 °C	+5 °C to +150 °C	+5 °C to +150 °C
Measuring positions for AVS	2	2	2	4
Measuring positions TC	2	2	2	4
Measuring positions micro TC	2	2	2	4
Temperature stability according DIN 58 966 at 25 °C	±0.02 K	±0.02 K	±0.02 K	±0.02 K
Size (W x H x D in mm)	355 x 370 x 250	355 x 370 x 250	355 x 370 x 250	605 x 370 x 250
Filling volume	18 l	15 l	15 l	27 l
Material	PMMA	St. steel & glass	St. steel & glass	St. steel & glass
Weight (empty)	~5 kg	~14 kg	~13.5 kg	~28 kg

At applications within normal temperature range (+5 °C up to approx. +40 °C) cooling will be necessary for maintaining temperature stability. This cooling can be carried out by flowing tap water or by use of an optional flow-through cooler (e.g. CK 310). For low temperature applications, an optional cryostat with high cooling power is required.

Ordering information

Type no.	Order no.	Description
CT 72/P, 230V	285418526	Immersion thermostat 230 V and thermostatic bath (acrylic glass container with two manual gauge slides), basic configuration for the attachment of one flow-through cooler.
CT 72/P, 115V	285418513	Immersion thermostat 115 V and thermostatic bath (acrylic glass container with two manual gauge slides), basic configuration for the attachment of one flow-through cooler.
CT 72/2, 230V	285418547	Immersion thermostat 230 V and thermostatic bath (stainless steel container with one manual gauge slide), basic configuration for the attachment of one flow-through cooler.
CT 72/2, 115V	285418532	Immersion thermostat 115 V and thermostatic bath (stainless steel container with one manual gauge slide), basic configuration for the attachment of one flow-through cooler.
CT 72/2-M, 230V	285418584	Immersion thermostat 230 V and thermostatic bath (stainless steel container with one manual gauge slide), equipped with two magnetic stirrer positions. Basic configuration for the attachment of one flow-through cooler.
CT 72/2-M, 115V	285418593	Immersion thermostat 115 V and thermostatic bath (stainless steel container with one manual gauge slide), equipped with two magnetic stirrer positions. Basic configuration for the attachment of one flow-through cooler.
CT 72/2-TT, 230V	285418615	Immersion thermostat 230 V and thermostatic bath (stainless steel container with one manual gauge slide), basic configuration for the attachment of one flow-through cooler.
CT 72/2-TT, 115V	285418607	Immersion thermostat 115 V and thermostatic bath (stainless steel container with one manual gauge slide), basic configuration for the attachment of one flow-through cooler.
CT 72/4, 230V	285418568	Immersion thermostat 230 V and thermostatic bath (stainless steel container with two manual gauge slides), basic configuration for the attachment of one flow-through cooler.
CT 72/4, 115V	285418554	Immersion thermostat 115 V and thermostatic bath (stainless steel container with two manual gauge slides), basic configuration for the attachment of one flow-through cooler.
CT 72/E, 230V	285418501	Immersion thermostat 230 V/50 Hz
CT 72/E, 115V	285418495	Immersion thermostat 115 V/60 Hz
CK 310, 230V	285414320	Flow-through cooler CK 310, version: 230 V/50-60 Hz with cooling coil made of stainless steel
CK 310, 115V	285414310	Flow-through cooler CK 310, version: 115 V/50-60 Hz with cooling coil made of stainless steel
More Accessories and spare parts		
VZ 5402	285415171	Manual gauge slide for transparent thermostats
VZ 5403	285420684	3-fold manual gauge slide for transparent thermostats
VZ 5404	285418573	Dust protection cover for transparent thermostat
VZ 5405	285418620	Transparent thermostatic bath backlight

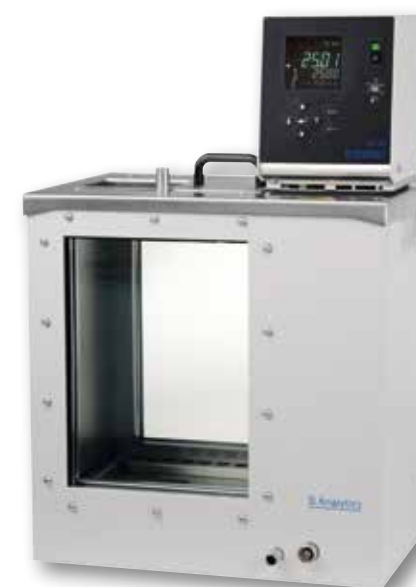

CT 72/2



CK 310

2 Viscometers

2.1 Viscometers and their range of use

Measurement substance property	Viscometer type						
	Ubbelohde	Micro-Ubbelohde	TC Ubbelohde	Ostwald	Micro-Ostwald	Cannon-Fenske-Routine	Cannon-Fenske-reverse flow
Transparent liquids manual measurement	✓	✓	■	■	■	■	■
Transparent liquids automatic measurement	✓	✓	■	■	■	■	■
Opaque liquids manual measurement	■	■	■	■	■	■	■
Opaque liquids automatic measurement	■	■	✓ ¹⁾	■	■	■	■
Foaming liquids	■	■	■	■	■	■	■
Liquid mixture with highly volatile components	■	■	■	■	■	■	■
Minimum measurement substance and/or rinsing agent quantities	■	✓	■	■	✓	■	■
High-temperature or low-temperature measurements	■	■	■	■	■	■	■

Selection of glass capillary viscometers

✓ use preferably
■ highly suitable
■ less suitable
■ unsuitable

¹⁾ up to 30,000 mm²/s
²⁾ above 30,000 mm²/s

2.2 Ubbelohde viscometers normal form (DIN)

Viscometers with suspended level for determination of absolute and relative kinematic viscosity of liquids with Newtonian flow behavior. The calibrated viscometers are delivered with manufacturer's certificate in accordance with DIN 55 350, Part 18. All viscometers are provided with ring marks. This ensures that viscometers for automatic mea-

surements can also be checked by means of manual measurements. The recommended minimum flowthrough time is 200s for absolute measurements of kinematic viscosity. For relative measurements (polymer analytics), the minimum flow time of 50s is allowed by ISO 1628-1 (depending on the capillary size).

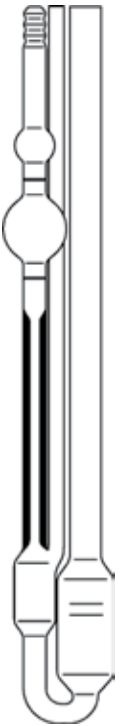

calibrated, with constant, for manual measurements		calibrated, with constant for manual measurements; automatic measurement with stand AVS®/SK-HV		$v=K \cdot t$ $K=\frac{v}{t}$ $t=\frac{v}{K}$	Ubbelohde-Viskosimeter (DIN)		
Type No.	Order No.	Type No.	Order No.	Capillary No. acc. DIN	Capillary Ø i ± 0,01 [mm]	Constant K (approx.)	Measuring range [mm ² /s] (approx.)
501 00	285400004	-	-	0	0.36	0.001	0.3 to 1
501 03	285400012	-	-	0c	0.47	0.003	0.5 to 3
501 01	285400029	-	-	0a	0.53	0.005	0.8 to 5
501 10	285400037	-	-	I	0.63	0.01	1.2 to 10
501 13	285400045	-	-	Ic	0.84	0.03	3 to 30
501 11	285400053	-	-	Ia	0.95	0.05	5 to 50
501 20	285400061	-	-	II	1.13	0.1	10 to 100
501 23	285400078	-	-	IIc	1.50	0.3	30 to 300
501 21	285400086	-	-	IIa	1.69	0.5	50 to 500
501 30	285400094	-	-	III	2.01	1	100 to 1,000
501 33	285400107	-	-	IIIc	2.65	3	300 to 3,000
501 31	285400115	-	-	IIIa	3.00	5	500 to 5,000
501 40	285400123	-	-	IV	3.60	10	1,000 to 10,000
-	-	502 43	285400131	IVc	4.70	30	3,000 to 30,000
-	-	502 41	285400148	IVa	5.34	50	6,000 to 30,000
-	-	502 50	285400156	-	6.30	100	above 10,000

not calibrated, without constant; for determination of relative viscosity		calibrated, with constant for automatic measurements		$v=K \cdot t$ $K=\frac{v}{t}$ $t=\frac{v}{K}$	$v=\frac{K}{t}$	kinematic viscosity in mm ² /s = constant [mm ² /s] = flow-through time in s	
Type No.	Order No.	Type No.	Order No.	Capillary No. acc. DIN	Capillary Ø i ± 0,01 [mm]	Constant K (approx.)	Measuring range [mm ² /s] (approx.)
-	-	532 00	285400164	0	0.36	0.001	0.3 to 1
530 03	285400304	532 03	285400201	0c	0.47	0.003	0.5 to 3
530 01	285400312	532 01	285400218	0a	0.53	0.005	0.8 to 5
530 10	285400329	532 10	285400226	I	0.63	0.01	1.2 to 10
530 13	285400337	532 13	285400234	Ic	0.84	0.03	3 to 30
530 11	285400338	532 11	285400172	Ia	0.95	0.05	5 to 50
530 20	285400345	532 20	285400242	II	1.13	0.1	10 to 100
530 23	285400353	532 23	285400259	IIc	1.50	0.3	30 to 300
530 21	285400350	532 21	285400189	IIa	1.69	0.5	50 to 500
530 30	285400361	532 30	285400267	III	2.01	1	100 to 1,000
530 33	285400378	532 33	285400275	IIIc	2.65	3	300 to 3,000
530 31	285400370	532 31	285400197	IIIa	3.00	5	500 to 5,000
530 40	285400386	532 40	285400283	IV	3.60	10	1,000 to 10,000

2.3 Ubbelohde viscometers normal form (ASTM)



Viscometers with suspended level for determination of absolute and relative kinematic viscosity of liquids with Newtonian flow behavior. The calibrated viscometers are delivered with manufacturer's certificate in accordance with DIN 55 350, Part 18. All viscometers are provided with ring marks. This ensures that viscometers for automatic mea-

surements can also be checked by means of manual measurements. The recommended minimum flowthrough time is 200s for absolute measurements of kinematic viscosity. For relative measurements (polymer analytics), the minimum flow time of 50s is allowed by ISO 1628-1 (depending on the capillary size).

calibrated, with constant and calibration certificate for manual measurements		not calibrated, without calibration certificate for determination of relative Viscosity		calibrated, with constant and calibration certificate for automatic measurements		Capillary No.	Capillary Ø i ± 0,01 [mm]	Constant K (approx.)	Measuring range [mm ² /s] (approx.)
Type No.	Order No.	Type No.	Order No.	Type No.	Order No.				
525 00	285400501	526 00	285400707	527 00	285401255	0	0.24	0.001	0.35 to 1
525 03	285400518	526 03	285400715	527 03	285401271	0C	0.36	0.003	0.6 to 3
525 01	285400526	526 01	285400723	527 01	285401263	0B	0.46	0.005	1 to 5
525 10	285400534	526 10	285400731	527 10	285401152	1	0.58	0.01	2 to 10
525 13	285400542	526 13	285400748	527 13	285401169	1C	0.78	0.03	6 to 30
525 11	285400550	526 11	285400750	527 11	285401170	1B	0.88	0.05	10 to 50
525 20	285400559	526 20	285400756	527 20	285401177	2	1.03	0.1	20 to 100
525 23	285400567	526 23	285400764	527 23	285401185	2C	1.36	0.3	60 to 300
525 30	285400575	526 30	285400772	527 30	285401193	3	1.83	1	200 to 1,000
525 33	285400583	526 33	285400789	527 33	285401288	3C	2.43	3	600 to 3,000
525 40	285400591	526 40	285400797	527 40	285401296	4	3.27	10	2,000 to 10,000
525 43	285400604	526 43	285400801	527 43	285401309	4C	4.32	30	6,000 to 30,000

Ubbelohde Viscometer (ASTM)

- in accordance with ISO 3105, ASTM D 446
- filling quantity: 15 to 20 ml
- overall length: approx. 285 mm

2.4 Ubbelohde viscometers, with additional tube and threads

Viscometers with suspended level for determination of absolute or relative kinematic viscosity. These viscometers are preferably used for automatic measurements. The additional filling and cleaning tube and the glass thread ensure safe operational use. The cali-

brated viscometers are delivered with manufacturer's certificate in accordance with DIN 55 350, Part 18. The ring marks present serve as auxiliary marks in case the viscometers must be checked by manual measurements.

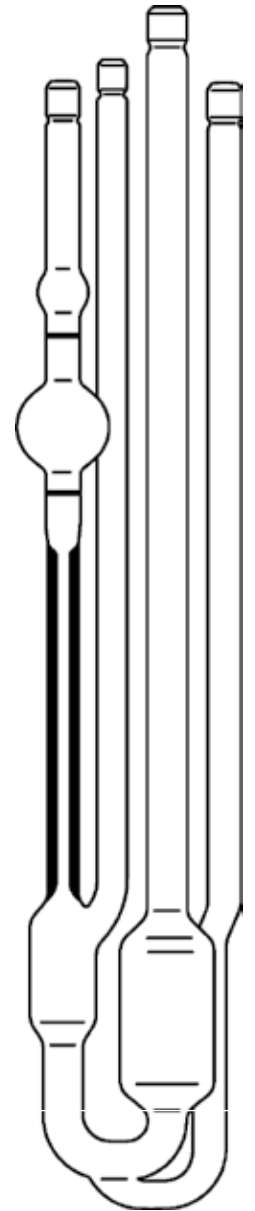

calibrated, with constant and calibration certificate for automatic measurements		Ubbelohde viscometer (DIN)			
Type No.	Order No.	Capillary No.	Capillary Ø i [mm]	Constant K (approx.)	Measuring range [mm ² /s] (approx.)
541 03	285401925	0c	0.47	0.003	0.5 to 3
541 01	285401917	0a	0.53	0.005	0.8 to 5
541 10	285401933	I	0.63	0.01	1.2 to 10
541 13	285401941	Ic	0.84	0.03	3 to 30
541 11	285401950	Ia	0.95	0.05	5 to 50
541 20	285401958	II	1.13	0.1	10 to 100
541 23	285401966	IIc	1.50	0.3	30 to 300
541 21	285408719	IIa	1,69	0,5	50 to 500
541 30	285401974	III	2.01	1	100 to 1,000
541 33	285401982	IIIc	2.65	3	300 to 3,000
541 40	285401999	IV	3.60	10	1,000 to 10,000
541 43	285402000	IVc	4,70	30	3.000 to 30,000

Ubbelohde viscometer (DIN)

- in accordance with ISO 3105, DIN 53 000 Part 1
- filling quantity: 18 to 22 ml
- overall length: approx. 290 mm

calibrated, with constant and calibration certificate for automatic measurements		Ubbelohde viscometer (ASTM)			
Type No.	Order No.	Capillary No. acc. ASTM	Capillary Ø i [mm]	Constant K (approx.)	Measuring range [mm ² /s] (approx.)
545 00	285402005	0	0.24	0.001	0.35 to 1
545 03	285402021	0C	0.36	0.003	0.6 to 3
545 01	285402013	0B	0.46	0.005	1 to 5
545 10	285402038	1	0.58	0.01	2 to 10
545 13	285402046	1C	0.78	0.03	6 to 30
545 11	285402042	1B	0.88	0.05	10 to 600
545 20	285402054	2	1.03	0.1	20 to 100
545 23	285402062	2C	1.36	0.3	60 to 300
545 30	285402079	3	1.83	1	200 to 1,000
545 33	285402087	3C	2.43	3	600 to 3,000
545 40	285402095	4	3.27	10	2,000 to 10,000
545 43	285402108	4C	4.32	30	6,000 to 30,000

Ubbelohde viscometer (ASTM)

- the technical measurement characteristics are in accordance with ISO 3105, ASTM D 446
- filling quantity: 15 to 22 ml
- overall length: approx. 290 mm

2.5 Ubbelohde viscometers with TC sensors

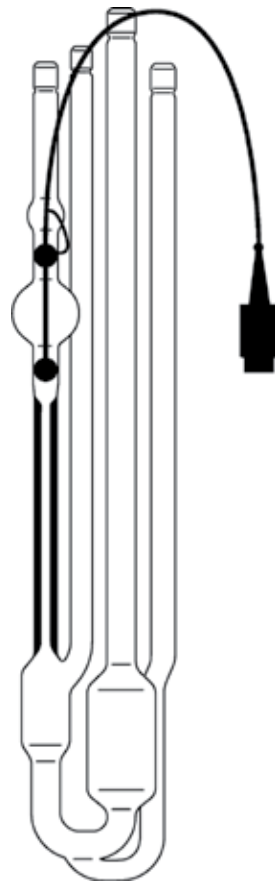

Viscometers with suspended level for determination of absolute and relative kinematic viscosity of liquids with Newtonian flow behavior. The measuring levels are marked by TC sensors. The meniscus passage is detected due to the different conductivity of the liquid phase and the gas phase. A measurement stand of the type series AVS®/S is not required. TC viscometers can be used to determine the kinematic viscosity of all liquids with Newtonian flow behavior.

They are especially suitable for liquids that cannot be detected with other systems: opaque and/or black samples.

Due to the electrical properties of TC sensors, it is important to ensure that a suitable type is selected for the required application temperature.

TC viscometers with additional filling and cleaning tube and with glass thread

- the technical measurement characteristics are in accordance with DIN 53 000, part 1, ISO 3105
- for use in combination with an automatic viscosity measuring instrument
- filling quantity: 18 to 22 ml
- overall length: approx. 355 mm
- suitable bracket Type No. 05393, Order No. 285405035

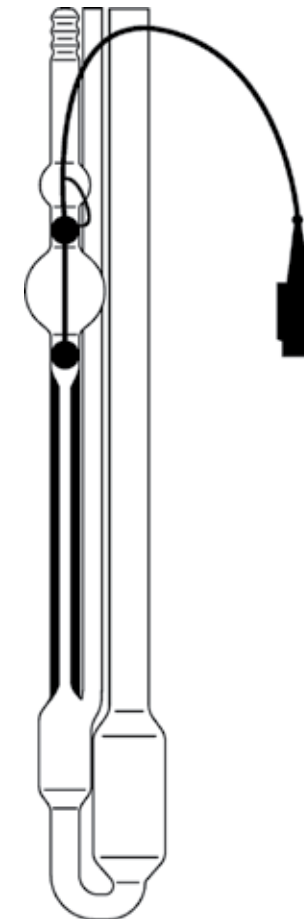

TC viscometers

- the technical measurement characteristics are in accordance with DIN 53 000, part 1, ISO 3105
- for use in combination with an automatic viscosity measuring instrument
- filling quantity: 15 to 20 ml
- overall length: ca. 355 mm
- suitable bracket Type No. 05393, Order No. 285405035

calibrated, with constant and calibration certificate for automatic measurements						Capillary No.	Capillary Ø i [mm]	Constant K (approx.)	Measuring range [mm ² /s] (approx.)
Type No.	Order No.	Type No.	Order No.	Type No.	Order No.				
+ 10 to + 80 °C		- 40 to + 30 °C		+ 70 to + 150 °C					
562 03	285423120	-	-	-	-	0c	0,47	0,003	0,5 to 3
562 10	285423130	563 10	285423240	564 10	285423330	I	0,63	0,01	1,2 to 10
562 13	285423140	563 13	285423250	564 13	285423340	Ic	0,84	0,03	3 to 30
562 20	285423150	563 20	285423260	564 20	285423350	II	1,13	0,1	10 to 100
562 23	285423170	563 23	285423270	564 23	285423360	IIc	1,51	0,3	30 to 300
562 21	285423160	-	-	-	-	IIa	1,69	0,5	50 to 500
562 30	285423180	563 30	285423280	564 30	285423370	III	2,05	1	100 to 1.000
562 33	285423200	563 33	285423290	564 33	285423380	IIIc	2,7	3	300 to 3.000
562 31	285423190	-	-	-	-	IIIa	3,0	5	500 to 5.000
562 40	285423210	563 40	285423300	564 40	285423390	IV	3,7	10	1.000 to 10.000
562 43	285423230	563 43	285423320	564 43	285423400	IVc	4,9	30	3.000 to 20.000
562 41	285423220	563 41	285423310	-	-	IVa	5,3	50	5.000 to 30.000

calibrated, with constant for automatic measurements						Capillary No.	Capillary Ø i [mm]	Constant K (approx.)	Measuring range [mm ² /s] (approx.)
Type No.	Order No.	Type No.	Order No.	Type No.	Order No.				
+ 10 to + 80 °C		- 40 to + 30 °C		+ 70 to + 150 °C					
567 03	285423420	-	-	-	-	0c	0,47	0,003	0,5 to 3
567 10	285423430	568 10	285423540	569 10	285423630	I	0,63	0,01	1,2 to 10
567 13	285423440	568 13	285423550	569 13	285423640	Ic	0,84	0,03	3 to 30
567 20	285423450	568 20	285423560	569 20	285423650	II	1,13	0,1	10 to 100
567 23	285423470	568 23	285423570	569 23	285423660	IIc	1,51	0,3	30 to 300
567 21	285423460	-	-	-	-	IIa	1,69	0,5	50 to 500
567 30	285423480	568 30	285423580	569 30	285423670	III	2,05	1	100 to 1.000
567 33	285423500	568 33	285423590	569 33	285423680	IIIc	2,7	3	300 to 3.000
567 31	285423490	-	-	-	-	IIIa	3,0	5	500 to 5.000
567 40	285423510	568 40	285423600	569 40	285423690	IV	3,7	10	1.000 to 10.000
567 43	285423530	568 43	285423620	569 43	285423700	IVc	4,9	30	3.000 to 20.000
567 41	285423520	568 41	285423610	-	-	IVa	5,3	50	5.000 to 30.000

2.6 Micro-Ubbelohde viscometers with TC sensors

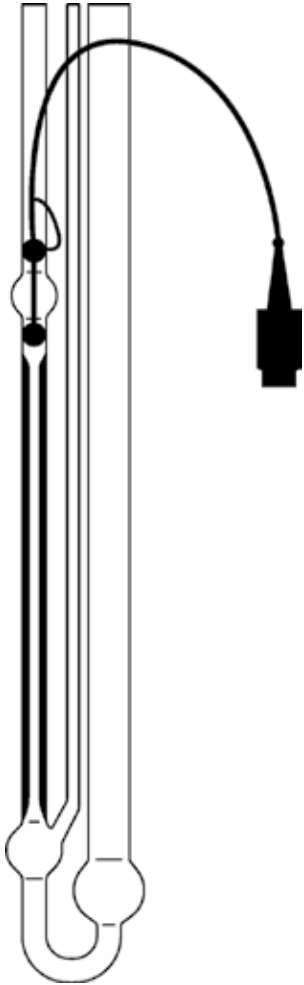

Viscometers with suspended level for determination of absolute and relative kinematic viscosity of liquids with Newtonian flow behaviour. The measuring levels are marked by TC sensors. The meniscus passage is detected due to the different conductivity of the liquid phase and the gas phase. A measurement stand of the type series AVS®/S is not required. TC viscometers can be used to determine the kinematic viscosity of all liquids with Newtonian flow behaviour.

They are especially suitable for liquids that cannot be detected with other systems: opaque and/or black and/or electrically conductive measuring samples.

Due to the electrical properties of TC sensors, it is important to ensure that a suitable type is selected for the required application temperature.

Micro TC viscometers

- the technical measurement characteristics are in accordance with DIN 53 000, Part 1
- for use in combination with an automatic viscosity measuring instrument
- filling quantity: 3 to 4 ml
- overall length: approx. 350 mm
- suitable bracket Type No. 05393, Order No. 285405035

calibrated, with constant and calibration certificate for automatic measurements						Capillary No.	Capillary Ø i [mm]	Constant K (approx.)	Measuring range [mm ² /s] (approx.)
Type No.	Order No.	Type No.	Order No.	Type No.	Order No.				
+10 ... +80 °C		-40 ... +30 °C		+70 ... +150 °C					
572 10	285423710	573 10	285423780	574 10	285423850	M I	0,40	0,01	0,4 to 6
572 13	285423720	573 13	285423790	574 13	285423860	M Ic	0,52	0,03	1,2 to 18
572 20	285423730	573 20	285423800	574 20	285423870	M II	0,70	0,1	4 to 60
572 23	285423740	573 23	285423810	574 23	285423880	M IIc	0,95	0,3	12 to 180
572 30	285423750	573 30	285423820	574 30	285423890	M III	1,26	1	40 to 800

2.7 Micro-Ubbelohde viscometers (DIN)



Viscometers with suspended level for determination of absolute and relative kinematic viscosity of liquids with Newtonian flow behavior. Due to their design, these viscometers are especially suitable for measurement of small liquid quantities and for particularly short running times.

ties and for particularly short running times.

All viscometers are provided with ring marks. This ensures that viscometers for automatic measurements can also be checked by means of manual measurements.

Micro-Ubbelohde viscometers (DIN)

The calibrated viscometers are delivered with manufacturer's certificate in accordance with DIN 55 350, Part 18.

- in accordance with DIN 53 000, Part 1
- filling quantity: 3 to 4 ml
- overall length: approx. 290 mm

calibrated, with constant and calibration certificate for manual measurement		calibrated, with constant and calibration certificate for automatic measurement		not calibrated, without calibration certificate; for determination of relative viscosity		Capillary No.	Capillary Ø i [mm]	Constant K (approx.)	Measuring range [mm ² /s] (approx.)
Type No.	Order No.	Type No.	Order No.	Type No.	Order No.				
536 10	285401009	537 10	285401103	538 10	285401206	M I	0,40	0,01	0,4 to 6
536 13	285401017	537 13	285401111	538 13	285401214	M Ic	0,52	0,03	1,2 to 18
536 11	285401050	537 11	285401150	538 11	285401220	M Ia	0,60	0,05	2 to 30
536 20	285401025	537 20	285401128	538 20	285401222	M II	0,70	0,1	4 to 60
536 23	285401033	537 23	285401136	538 23	285401239	M IIc	0,95	0,3	12 to 180
536 21	285401030	537 21	285401130	538 21	285401230	M IIa	1,07	0,5	20 to 300
536 30	285401041	537 30	285401144	538 30	285401247	M III	1,26	1	40 to 800

Viscometers for dilution viscometry

Viscometers with suspended level designed according to the principle of the Ubbelohde viscometers for determination of the limit viscosity number of polymers. The limit viscosity number can be determined automatically in

combination with one of our piston burettes TITRONIC® 300 or TITRONIC® 500.

- filling quantity: 15 to 75 ml
- overall length: approx. 290 mm

not calibrated without calibration certificate Model with glass filter and discharge tube on request						Capillary No.	Capillary Ø i [mm]	Constant K (approx.)	Measuring range [mm ² /s] (approx.)
Type No.	Order No.								
531 00	285401403				0	0,36	0,001	0,35 to 0,6	
531 03	285401428				0c	0,47	0,003	0,5 to 2	
531 01	285401411				0a	0,53	0,005	0,8 to 3	
531 10	285401436				I	0,64	0,01	1,2 to 6	
531 13	285401444				Ic	0,84	0,03	3 to 20	
531 20	285401452				II	1,15	0,1	10 to 60	



2.8 Cannon-Fenske viscometers



Cannon-Fenske routine viscometers

- comply with standards ISO 3105, BS 188 and ASTM D446 with respect to technical measuring specifications.
- are suitable for all Newtonian liquids with a viscosity of 0.35 to 20,000 mm²/s
- the present design has a deepening in the lower bend. Accordingly, these viscometers mit Abfallsystem can also be used for automatic measurements.
- filling quantity: approx. 7 to 10 ml
- overall length: approx. 245 mm

calibrated, with constant and calibration certificate for manual measurements		calibrated, with constant and calibration certificate for automatic measurements		Capillary No.	Capillary Ø i [mm]	Constant K (Richtwert)	Measuring range [mm ² /s] (approx.)
Type No.	Order No.	Type No.	Order No.				
513 00	285403507	520 00	285403704	25	0,30	0,002	0,4 to 1,6
513 03	285403515	520 03	285403712	50	0,44	0,004	0,8 to 3,2
513 01	285403523	520 01	285403729	75	0,54	0,008	1,6 to 6,4
513 10	285403531	520 10	285403737	100	0,63	0,015	3 to 15
513 13	285403548	520 13	285403745	150	0,78	0,035	7 to 35
513 20	285403556	520 20	285403753	200	1,01	0,1	20 to 100
513 23	285403564	520 23	285403761	300	1,27	0,25	50 to 200
513 21	285403572	520 21	285403778	350	1,52	0,5	100 to 500
513 30	285403589	520 30	285403786	400	1,92	1,2	240 to 1.200
513 33	285403597	520 33	285403794	450	2,35	2,5	500 to 2.500
513 40	285403601	520 40	285403807	500	3,20	8	1.600 to 8.000
513 43	285403618	520 43	285403815	600	4,20	20	4.000 to 20.000



Cannon-Fenske reverse flow viscometers

- Comply with standards ISO 3105, ASTM D 446 with respect to technical measuring specifications.
- filling quantity: approx. 12 ml
- overall length: approx. 295 mm

calibrated, with 3 ring marks, with 2 constants and calibration certificate, only for manual measurement		Capillary No.	Capillary Ø i [mm]	Constant K (approx.)	Measuring range [mm ² /s] (approx.)
Type No.	Order No.				
511 00	285403001	25	0,31	0,002	0,4 to 1,6
511 03	285403018	50	0,42	0,004	0,8 to 3,2
511 01	285403026	75	0,54	0,008	1,6 to 6,4
511 10	285403034	100	0,63	0,015	3 to 15
511 13	285403042	150	0,78	0,035	7 to 35
511 20	285403059	200	1,02	0,1	20 to 100
511 23	285403067	300	1,26	0,25	50 to 200
511 21	285403075	350	1,48	0,5	100 to 500
511 30	285403083	400	1,88	1,2	240 to 1200
511 33	285403091	450	2,20	2,5	500 to 2500
511 40	285403104	500	3,10	8	1.600 to 8.000
511 43	285403112	600	4,00	20	4.000 to 20.000

Cannon-Fenske routine viscometers with additional tube and threads

comply with standards ISO 3105, BS 188 with respect to technical measuring specifications. These viscometers are preferably used for automatic measurements. The additional filling and cleaning tube and the glass thread ensure safe operational use. The calibrated viscometers are delivered with manufacturer's certificate in accordance with DIN 55 350, Part 18.

- are suitable for all Newtonian liquids with a viscosity of 0.35 to 20,000 mm²/s.
- filling quantity: approx. 7 to 12 ml
- overall length: approx. 245 mm

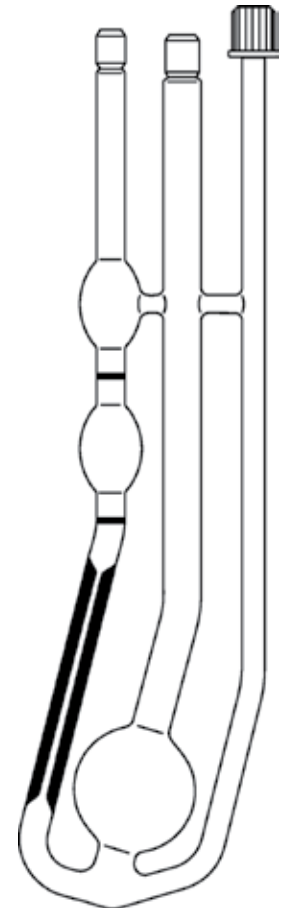

calibrated, with constant and calibration certificate for automatic measurements		Capillary No.	Capillary Ø i [mm]	Constant K (approx.)	Measuring range [mm ² /s] (approx.)
Type No.	Order No.				
546 00	285402116	25	0,30	0,002	0,4 to 1,6
546 03	285402132	50	0,44	0,004	0,8 to 3,2
546 01	285402124	75	0,54	0,008	1,6 to 6,4
546 10	285402149	100	0,63	0,015	3 to 15
546 13	285402157	150	0,78	0,035	7 to 35
546 20	285402165	200	1,01	0,1	20 to 100
546 23	285402181	300	1,27	0,25	50 to 200
546 21	285402173	350	1,52	0,5	100 to 500
546 30	285402198	400	1,92	1,2	240 to 1.200
546 33	285402202	450	2,35	2,5	500 to 2.500
546 40	285402219	500	3,20	8	1.600 to 8.000
546 43	285402227	600	4,20	20	4.000 to 20.000

2.9 Ostwald viscometers

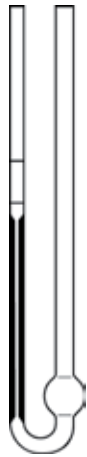

Ostwald viscometers

- filling quantity: 3 ml
- overall length: approx. 220 mm
- only available without calibration

with ring marks, without calibration certificate, for manual measurements		Capillary Ø i [mm]	Transit time for water ~ [s]	Constant K (approx.)	for use from [mm ² /s] (approx.)
Type No.	Order No.				
509 03	285404006	0,3	250	0,004	0,3
509 04	285404014	0,4	75	0,01	1
509 05	285404022	0,5	30	0,03	2,5
509 06	285404039	0,6	15	0,07	5,5
509 07	285404047	0,7	10	0,1	10

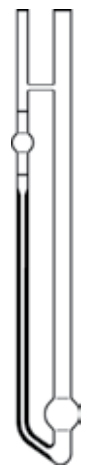

Micro-Ostwald viscometers

- are suitable for measurements of small liquid quantities even with tendency to excessive foam formation.
- filling quantity: 2 ml
- overall length: approx. 290 mm

calibrated, with ring marks, with constant and calibration certificate for manual measurements		calibrated, with ring marks, with constant and calibration certificate for automatic measurements		not calibrated, without calibration certificate; for determination of relative viscosity		Capillary No.	Capillary Ø i [mm]	Constant K (approx.)	Measuring range [mm ² /s] (approx.)
Type No.	Order No.	Type No.	Order No.	Type No.	Order No.				
516 10	285404203	517 10	285404306	518 10	285404409	I	0,43	0,01	0,4 bis 6
516 13	285404211	517 13	285404314	518 13	285404417	Ic	0,60	0,03	1,2 bis 18
516 20	285404228	517 20	285404322	518 20	285404425	II	0,77	0,1	4 bis 60
516 23	285404236	517 23	285404339	518 23	285404433	IIc	1,00	0,3	12 bis 180
516 30	285404244	517 30	285404347	518 30	285404441	III	1,36	1	40 bis 800

3 Accessories

3.1.1 Viscometers - Brackets and stands

Brackets and stands

All brackets and stands are designed to ensure that the viscometers are held vertically. They also protect the viscometers from breakage. The maximum deviation is < 1°.

In conjunction with Xylem Analytics Germany and other commercially available seethrough thermostats the viscometers can only be used with the appropriate stand or bracket.

For DIN Ubbelohde viscometers that are used as reference measuring standard, specifically modified bracket (VZ 5840, see below) must be used.

Brackets made of stainless steel suitable for use with all Ubbelohde viscometers

for manual and automatic measurements

Type No.	Order No.
053 92	285405043
VZ 5840 (accessory for reference measuring standard)	285417201

suitable for use with Ubbelohde viscometers with TC sensors

Type No.	Order No.
053 93	285405035

suitable for use with Cannon-Fenske reverse flow viscometers

for manual measurements (not illustrated)

Type No.	Order No.
053 96	285405019

suitable for use with Micro-Ostwald viscometers

for manual and automatic measurements

Type No.	Order No.
053 97	285405027



Accessories for brackets for reference measuring standard

DIN Ubbelohde viscometers which are used as testing standard

Type No.	Order No.
VZ 5840	285417201

should be stored in a specially modified viscometer bracket according to official inspection / calibration authorities. The extension set for the test standard (VZ 5840) as supplement to the bracket

guarantees vertical slope with a maximum deviation of $< 1^\circ$ and the centered positioning of the capillaries.



Holder made of polyamid

Polyamide bracket

for use with Cannon-Fenske routine viscometers, Cannon-Fenske reverse flow viscometers and all Ostwald viscometers for manual measurements only

Typ-Nr.	Bestell-Nr.
064 99	285405105

PTFE bracket

for use with Cannon-Fenske routine viscometers, for automatic measurements only (not illustrated), to be applied in measuring stands AVS®/S, AVS®/SK

Typ-Nr.	Bestell-Nr.
065 99	285405113



3.1.2 Temperature stabilization jackets

Temperature stabilization jackets

In the absence of a see-through thermostat the temperature of capillary viscometers can be stabilized in this type of jacket using circulation thermostats in the temperature range 0 to 180 °C.

The support plate has been designed to facilitate changing the viscometer when required. An additional hole is provided in the support plate so that a control thermometer can be fitted. A quick-action seal simplifies changing viscometers.

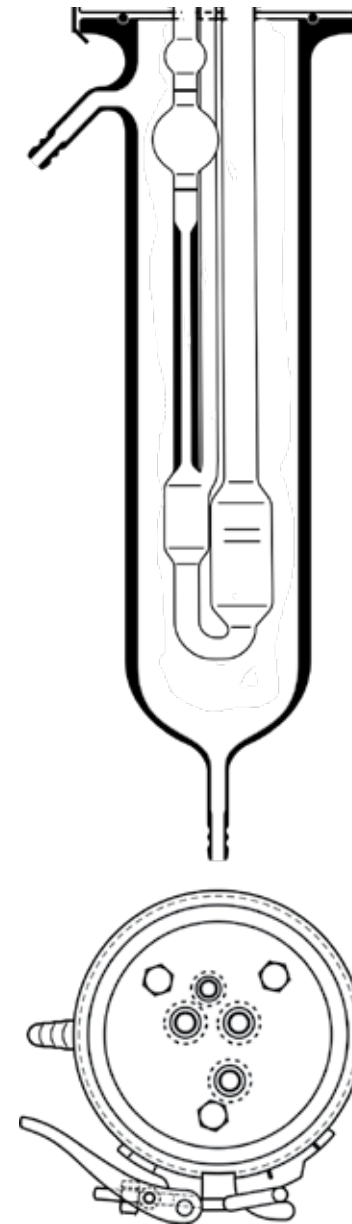

Temperature stabilization jacket with support plate for Ubbelohde viscometers

Type No.	Order No.	Item No.	Comment
577 00	285405508		complete, without viscometer
Component parts			
577 01	285405516	1	temperature stabilization jacket, straight
238 00	285424130	2	support plate with 4 silicone rings for Ubbelohde viscometers (d = 4, 6, 8 and 10 mm)
225 34	285405532	3	silicone O-ring, ND 60
072 34	285405549	4	quick-action seal, NW 60

Silicone rings

Type No.	Order No.	d mm	D mm	h mm
228 11	285405808	4	10	5
228 14	285405816	6	16	5
228 16	285405824	8	16	5
228 17	285405832	10	16	5

3.1.3 LabPump

LabPump

The LabPump VZ 5655 (not illustrated) used with manual and semi-automatic measurements to extract and pump solutions:

- For manual measurements: To suck sample to the measuring bulb.
- For semi-automatic AVS®-Systems: To discharge sample to a waste bottle.

Since the LabPump VZ 5655 and the connections are made of PTFE or stainless steel, the pump is suitable for use with aggressive mediums.

The discharging of the sample from the viscometer is possible for viscosities up to 30000 mm²/s. Additional to the LabPump, the discharge set type no VZ 5624 is required.

Type No.	Order No.
VZ 5655, 230V	1040755
VZ 5665, 115V	1040757
VZ 5624	285414845

3.2 A. for Measurement Devices

3.2.1 Control thermometers

Control thermometers

Precision thermometers type TFX 430 of brand Ebro® with high accuracy ± 0.05 °C to control bath temperature. The thermometer is equipped with an adapter for installation to bath thermostats of series CT72 and CT52.

Type No.	Order No.	Article	Description
VZ 7330	285421110	Control thermometer	Pt100 resistance thermometer, with manufacturer's calibration
VZ 7340	285421120	Control thermometer	Pt100 resistance thermometer, with DAkkS calibration at 20 °C
VZ 7341	285421130	Control thermometer	Pt100 resistance thermometer, with DAkkS calibration at 25 °C
VZ 7342	285421140	Control thermometer	Pt100 resistance thermometer, with DAkkS calibration at 30 °C
VZ 7343	285421170	Control thermometer	Pt100 resistance thermometer, with DAkkS calibration at 40 °C
VZ 7344	285421180	Control thermometer	Pt100 resistance thermometer, with DAkkS calibration at 100 °C
VZ 7345	285421290	Control thermometer	Pt100 resistance thermometer, with DAkkS calibration at 135 °C

Technical Data

- Measuring range: -100 to +500 °C
- Accuracy: ± 0.05 °C from -50 to +199.99 °C
- Operating temperature: -20 °C to +50 °C
- Sensor length: 200 mm
- Four-wire system
- Water proof acc. IP 67
- Battery operated, battery lifetime approx. 5 years
- Battery exchangeable

The available control thermometers only differ regarding the calibration: Manufacturer's calibration (VZ 7330) respective DAkkS calibration for certain temperatures, which are commonly used in viscometry.



3.2.2 Safety devices

Safety bottle for suction mode

For operation in suction mode, AVS® systems have to be protected by a safety bottle. The bottle, being positioned between capillary tube of viscometer and ViscoPump, avoids the entering of liquid into the control unit: In case of malfunction, the sample is first hauled into the viscometer.

The safety bottle without glass screws, VZ 7022, for use with silicon caps and hoses, is contained in the supplement set VZ 8526. By using the enclosed hose, the standard hose set VZ 5505 for pressure mode can be switched to suction mode.

Beside of the safety bottle VZ 7022, there is also safety bottle VZ 7021 with glass screws, to connect with flanged PTFE hoses and screw cap connectors. The PTFE hoses are mainly used for aggressive samples as sulfuric acid, which would attack silicon.

With PTF tubes there is - depending on the application - a broad variety due to different tube length, diameter and screw connectors, so that they cannot be described in this catalogue. Please contact for special requests your sales partner for SI Analytics® viscometry systems.



Type No.	Order No.	Description
VZ 7022	285420277	Safety bottle without glass screws
VZ 8526	285420530	Upgrading set "suction" for ViscoPump in addition to hose set VZ 5505
VZ 7021	285420269	Safety bottle with glass screws

Safety sensors

When using the safety bottle VZ 7021 / VZ 7022, the safety device for vacuum line VZ 8552 is strongly recommended. This capacitive sensor is mounted under the safety bottle and - in case of malfunction - registers liquid, resulting in a shutdown of the ViscoPump.

In case of an attached waste system, additionally the safety sensor VZ 8551 can be used: This safety sensor detects the weight of the waste bottle and, in case of overfill, switches off the pumping of the waste liquid.

Type No.	Order No.	Description
VZ 8552	1054303	Safety sensor for suction line, capacitive sensor
VZ 8551	1054112	Safety sensor for waste bottle

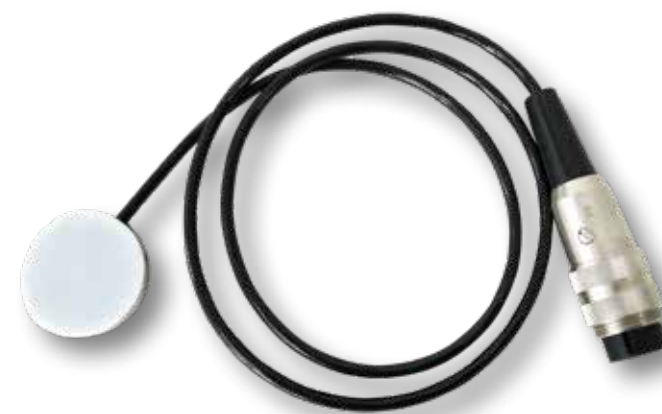

3.2.3 Filtration system ProClean II



Filtration system ProClean II

For filtration of solutions in viscometry. All standard solutions can be filtered, also with aggressive solvents used in polymer analytics. The system is configured for 100 ml screw neck bottles GL 45. The solutions are filtered by using wire-mesh filters made of Hastelloy or filter disks made of vitreous PE, fixed on a holder by a screw cap. The sample solutions are filtered by sucking through the wire mesh by using disposable syringes with luer-fitting (e.g. 20ml, not in scope of supply). As filtration is done by suction, there is no risk of splashing - important for filtration of dangerous liquids. After use, the filter blanks can be cleaned and reused.

The single components of the filtration system can be ordered separately.



Reusable filter VZ 7094, VZ 7095



Disposable filter VZ 7097, VZ 7098

Type No	Order No.	Article	Description
VZ 7090	285422500	Filtration system ProClean II, Set-5	5x sample bottles with screw caps and filter holders; filter blanks (Hastelloy) 20µm and 30µm mesh size (10pcs. per set)
VZ 7092	285422470	Filter holder for ProClean II	5 pcs.
VZ 7093	285422510	Screw caps for ProClean II	For fixing of filters, 10 pcs
VZ 7094	285422480	Filter 20µm mesh size	Hastelloy C4, 10 pcs
VZ 7095	285422520	Filter 30µm mesh size	Hastelloy C4, 10 pcs
VZ 7096	285422490	Bottle set for ProClean II	5x sample bottles with screw caps (with and without bore hole)
VZ 7097	285422590	Filter disks for ProClean II	PE, 50 pcs
VZ 7098	285422600	Filter disks for ProClean II	PE, 500W pcs

3.2.4 Thermostat vessel for ViscoClock plus

The standards for capillary viscometry require an accuracy for temperature control of ± 0.02 K (ISO 3104, DIN 53 000, ASTM D445) respective ± 0.05 for relative measurements (ISO 1628-1)

To achieve this accurate tempering, for viscometry we recommend our high-precision glass-panelled bath thermostats.

As an alternative, in case of the ViscoClock plus we offer a special double wall vessel for tempering. This vessel made of DURAN® glass is connected to a thermostat bath circulator.

The temperature control vessel can also be used for manual viscosity measurement, using a stopwatch and our viscometer brackets (e.g. 053 92).

Due to unavoidable heat loss and for safety reasons, the range of measuring temperature is restricted to ± 15 °C compared to room temperature.

For better temperature control, the use of an additional magnetic stirrer is recommended.

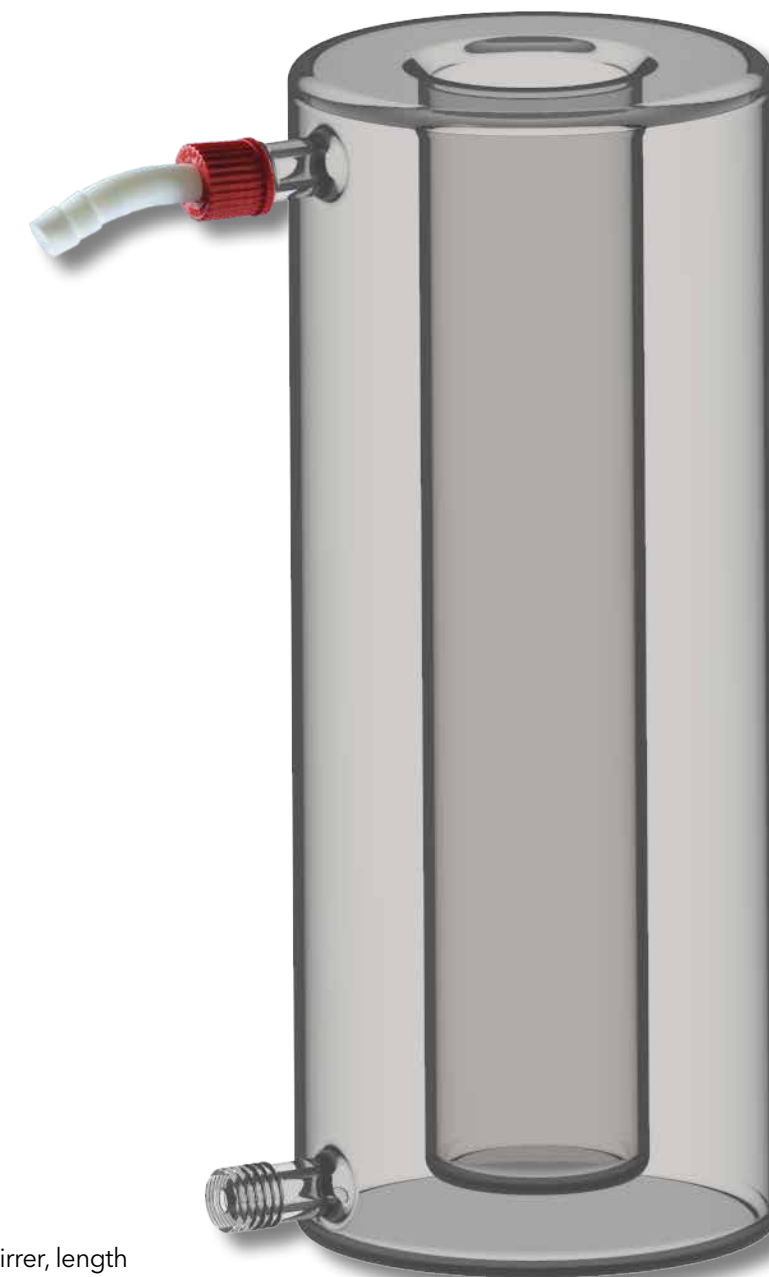

Specifications

- Temperature range: +10 to +40 °C
- Temperature accuracy: ± 0.05 K
- Diameter of tubing olive: 10.5 mm
- Recommended: Stirring using magnetic stirrer, length of stirring bar approx. 40 mm.

Type No.	Order No.	Description
VZ 6574	285424400	Temperature control vessel for ViscoClock plus

3.2.5 Burette TITRONIC® 500 for sample preparation

For viscometry of polymer solutions, sample preparation has to be done first. As an alternative to volumetric flasks, SI Analytics® offers the piston burette TITRONIC® 500 together with an exchangeable head. For dosing aggressive or high-viscous solvents, e.g. sulfuric acid or phenol/dichlorobenzene, a special and robust exchangeable head WA 50 V was designed.

There are the following advantages for sample preparation with the TITRONIC® 500 in comparison to using volumetric flasks:

- No manual work with aggressive solvents.
- When preparing in a volumetric flask, the weighing has to be done precisely to reach a target value, e.g. 250 mg when using a 50 ml flask for a concentration of 0.5 g/dl. The precise weighing is difficult for polymer samples, e.g. granules. With TITRONIC® 500, the dosed solvent volume matches exactly to the sample weight - therefore it becomes obsolete to reach exact target sample weight.
- When using TITRONIC® 500, standard sample bottles can be used instead of volumetric flasks - no more filling-up to the graduation mark.
- In case that a stirring bar is necessary for dissolution, in volumetric flasks it has to be taken out and adhering liquid has to be rinsed to the flask. This is not necessary with the piston burette, as target volume is dosed before dissolving.
- If sample is heated for dissolution, in volumetric flasks the solution needs to cool down to room temperature before fill-up.
- High reproducibility ($\pm 0.2\%$) of dosing volume.
- Simple and inexpensive compared to systems using gravimetric solvent dosing.
- Interchangeable unit WA 50 V with highly resistant dosing piston, ensuring tightness also for aggressive and high viscous solvents (e.g. 96 % sulfuric acid).



Beside of the sample weight, in the software of TITRONIC® 500 also the content of foreign substances, e.g. glass fibers, can be typed in. This percentage of sample weight is disregarded for calculation of the amount of solvent. Therefore the solvent amount is calculated on the pure polymer weight, according to viscometry standards, e.g. ISO 1628 or ISO 307.



Type No.	Order No.	Article	Description
T 500	285220200	TITRONIC® 500	TITRONIC® 500 basic unit without magnetic stirrer TM 235, with stand rod and titration clamp Z 305, and power supply 100-240 V
T 500-M1	285220210	TITRONIC® 500 with magnetic stirrer	TITRONIC® 500 basic unit with magnetic stirrer TM 235, with stand rod and titration clamp Z 305, and power supply 100-240 V
WA 50 V	285220360	50 ml interchangeable unit for aggressive solvents, e.g. conc. sulfuric acid	with brown glass bottle for titrant, GL 45 and S 40-bottle adapter, tubes, drip tube and titration tip
WA 50	285220350	50 ml interchangeable unit for aqueous solutions or non-aggressive solvents, e.g. ethanol, acetone	with brown glass bottle for titrant, GL 45 and S 40-bottle adapter, tubes, drip tube and titration tip

3.2.6 AVS® measuring stands

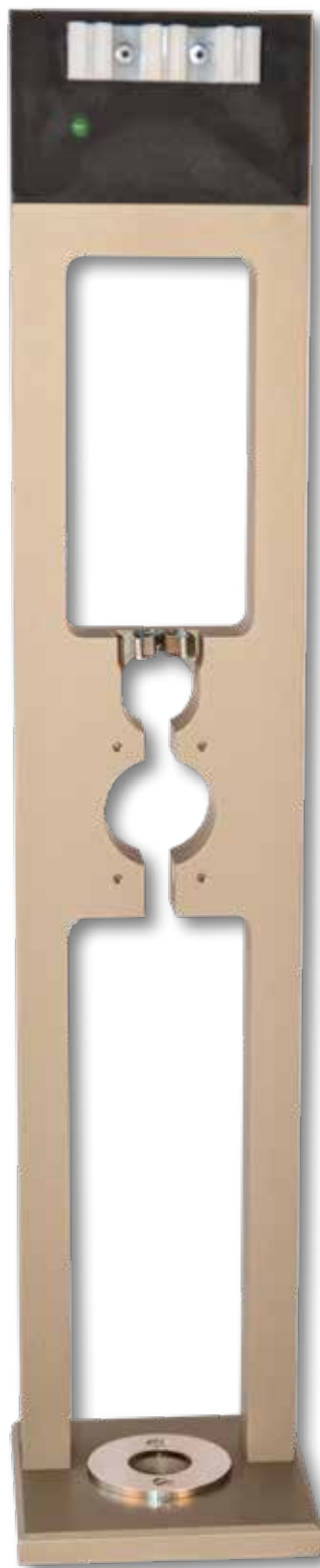

AVS® measuring stands

Measuring stands of the series AVS®/S can be used to measure the flow-through time in viscometers automatically. The measuring stands can be connected to all measuring instruments made by Xylem Analytics Germany for automatic measurement of viscosity and operate with all standard viscometers for repetitive measurements (except Ostwald viscometer type series 509 xx).

Automatic measurements have the following advantages:

- the repetitive standard deviation is less than for manual measurements
- the measurement is free from subjective factors of influence
- the results can be printed and/or be automatically documented with a data memory system
- automatic processing of sample series is available.

The measuring stands or brackets can be exchanged, having only negligible influence to the flow time:

The distance between the levels of the automatic optoelectronic unloading system is 40.00 mm \pm 0.03 mm. Due to the low tolerance, the exchange of a measuring stand results in a deviation of only \pm 0.05 % for Ubbelohde viscometers.

For repetitive measurements with viscosity measuring instruments and Ubbelohde viscometers with measuring stands, the standard deviation ca. \pm 0.03 % for stable and particle-free sample liquids.

Manually calibrated Ubbelohde viscometers can also be used in AVS® measuring stands. If the automatic sensing levels do not correspond to the ring marks, the height difference of the meniscus detection system will result in a changed viscometer constant. The difference amounts to 0.1% per millimeter of height offset for Ubbelohde viscometers.

Type No.	Order No.	Description
Measuring stand AVS®/S	285410502	Metal measuring stand AVS®/S, preferably for nonaqueous bath fluids
Measuring stand AVS®/SK	285410876	PVDF measuring stand AVS®/SK, corrosion-free, suitable for aqueous and nonaqueous bath fluids
Measuring stand AVS®/SK-CF	285410892	PVDF measuring stand AVS®/SK-CF, particularly for the use of Cannon-Fenske routine viscometers
Measuring stand AVS®/SK-V	285410905	PVDF measuring stand AVS®/SK-V, particularly for the use of dilution viscometers

Measuring stands

	AVS®/S	AVS®/S-HT	AVS®/SK	AVS®/S-CF	AVS®/SK-V
Available viscometers	Ubbelohde viscometers in accordance with DIN, ASTM, ISO 3105, Micro-Ubbelohde viscometers, Micro-Ostwald viscometers			Cannon-Fenske-routine viscometer	Ubbelohde-dilution viscometer
Temperature range	-80 to +80 °C	-80 to +200 °C	-40 to +80 °C	-80 to +80 °C	-40 to +80 °C other temperature ranges available on request
Suitable brackets (type no.)	05392 05397			no bracket required	
Material	Aluminium, TiO ₂ -anodized		PVDF, stainless steel	Aluminium, TiO ₂ -anodized	PVDF, stainless steel
Dimensions (W x H x D) mm	90 x 447 x 90	90 x 496 x 90	90 x 447 x 90	90 x 447 x 90	90 x 447 x 90
Weight (kg) appr.	1.0	1.25	0.8	1.0	0.8
Accessories included in scope of delivery	Bracket Type No. 05392 for Ubbelohde viscometers, tube/cable combination VZ 5505			tube/cable combination VZ 5505	tube/cable combination VZ 5857, magnetic stirring rods, fastening springs for viscometer

Note:

When TC viscometers are being used, a bracket type no. 053 93, with the necessary tube set is required only. A measuring stand is not required.

Suitable for use with the measuring units: AVS® 370, AVS® 470, AVS®Pro (optical detection)

Suitable for use with the thermostatic baths: CT 72/P, CT 72/2-TT, CT 72/2, CT 72/4

Electrical connection: Cable VZ 6225 for all measuring stands to all instruments (is included in hose sets VZ 5505, VZ 5622 and VZ 5857), control lamp as function display

Distance between measuring levels: 40.00 mm \pm 0.03 mm at 25 °C

Signal transmission: Optically using optical fibres from the measuring level in the stand head, converted into analogue signal from stand to measuring instrument

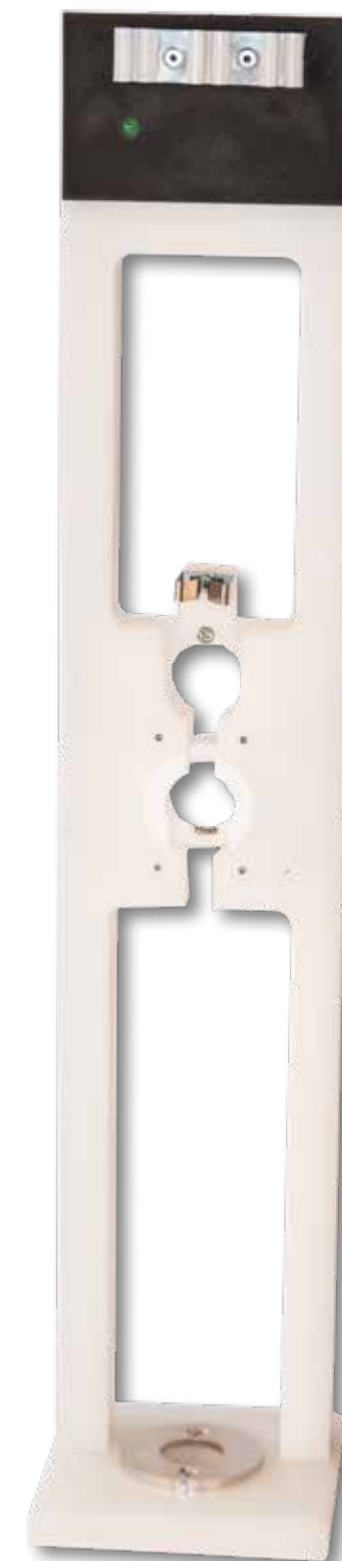

More SI Analytics Products

Titration

Dosing, titrating and water analysis according to Karl Fischer can be so easy

The Titrators of the TitroLine® series

Based on our know-how, we have developed a range of new reliable laboratory instruments for dosing, titrating and Karl Fischer water analysis: The burettes TITRONIC® 300 and 500 and the titrators TitroLine® 5000, 7000, 7500 KF, 7500 KF trace and the universal titrators TitroLine® 7750 and 7800. These instruments combine easy handling with maximum accuracy, and the robustness required for the daily operation in the laboratory.

- For the completely successful laboratory operation we also offer a wide range of accessories perfectly supporting the titrators with all their functions, such as the sample changers TW alpha plus and TW 7400, the burette TITRONIC® 500.



Sample changer TW alpha plus

- The new Titrator TitroLine® 7800 gives even more options

The TitroLine® 7800 is as well as the TitroLine® 7750 the all-rounder for both potentiometric titration and volumetric KF titration. Compared with the TitroLine® 7750 the TitroLine® 7800 offers the opportunity to also connect digital IDS sensors.



All-rounder: TitroLine® 7800



OptiLine 6

OptiLine 6 sensor

Many titration applications and methods, e.g. N Ph.Eur or USP prescribe the use of an indicator for the titration end point. There are also methods that explicitly require the use of a photometric sensor. The OptiLine 6 is a new photometric sensor that can be used like any other sensor. Thanks to the additional analog BNC / DIN connection, it can be connected to any titrator or even a pH meter with an appropriate measuring input.

Perfectly matching measurement systems

Benchtop and handheld meters

We offer several product lines for a wide range of applications. From the beginner class to the digital multi-channel device you get everything from a single source.



Laboratory electrodes

Suitable for our versatile devices, we offer countless types of electrodes for almost every application. These electrodes are still produced by hand at our location in Mainz in order to ensure the best possible quality and a long shelf life and precise measurement.



Process electrodes, armatures and accessories

The reliable measuring of pH, ORP, conductivity and D.O. values up to temperature within the process requires individual solutions. Our extensive range of process electrodes includes all applications for measurements in aqueous solutions in the temperature range from -30 °C to 140 °C at a pressure up to 12 bar. Furthermore, many of our electrodes are registered according to the ATEX guidelines 94/9/EG. The retractable holders and their control system enable flexible measurements with an ideal positioning of the electrode in the medium.

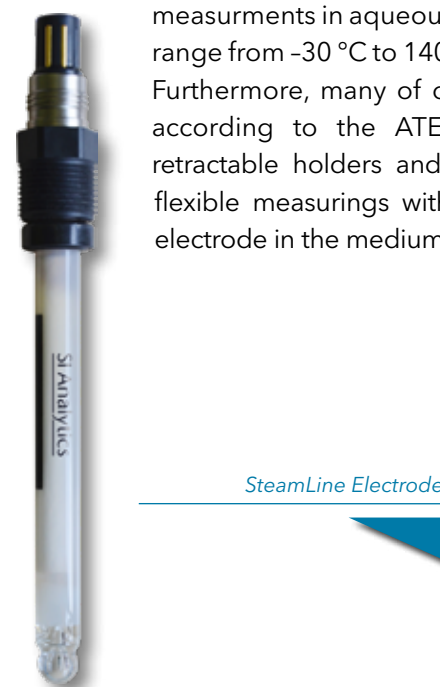

Hotplates and Stirrers

The laboratory hotplates from SI Analytics have the benefits of the glass-ceramic heating surface which has proven by millions in households. Chemical resistance, a high-grade surface quality and a resistance to temperature shock of more than 700 °C provide the user maximum benefits compared to conventional hot plate materials. The always plane and pore-free surface enables even most stubborn dirt to be removed.



Notes

A series of horizontal dotted lines for taking notes on both pages.

Xylem | 'zīləm|

- 1) The tissue in plants that brings water upward from the roots;
- 2) a leading global water technology company.

We're a global team unified in a common purpose: creating innovative solutions to meet our world's water needs. Developing new technologies that will improve the way water is used, conserved, and re-used in the future is central to our work. We move, treat, analyze, and return water to the environment, and we help people use water efficiently, in their homes, buildings, factories and farms. In more than 150 countries, we have strong, long-standing relationships with customers who know us for our powerful combination of leading product brands and applications expertise, backed by a legacy of innovation.

For more information on how Xylem can help you, go to www.xyleminc.com

SI Analytics

a **xylem** brand

Xylem Analytics Germany Sales GmbH & Co. KG SI Analytics

Hattenbergstrasse 10
55122 Mainz
Germany

Phone: +49.(0)6131.66.5111
Fax: +49.(0)6131.66.5001
E-Mail: si-analytics@xyleminc.com
Internet: www.XylemAnalytics.com



presented by

SI Analytics is a trademark of Xylem Inc. or one of its subsidiaries.

© 2019 Xylem, Inc. 980 087US Version September 2019